

MARCH, 1925

25 CENTS

RADIO

(Reg. U. S. Pat. Off.)



In This Issue:

HOW TO MAKE A SUIT-CASE RECEIVER
REMARKABLE PICTURES OF RADIO IN CANADA.
NEW REFINEMENTS IN BEST'S 45,000 CYCLE SUPER-HETERODYNE.
SIMPLE THEORY OF BALANCED TUNED RADIO FREQUENCY AMPLIFICATION.



Selections from Carmen

says the broadcasting announcer, and in a moment you are transported to old romantic Spain, to enticing, sunny Seville. That is but one of the endless joys of radio owning. For the full enjoyment of modern life, radio has become a necessity. For full enjoyment of radio, you will find Cunningham Tubes essential.

Since 1915—Standard for all sets
Types C-301A C-299 C-300 C-11 C-12

In the orange and blue carton



Cunningham RADIO TUBES

Home Office
182 Second Street,
SAN FRANCISCO

E. J. Cunningham Inc.

CHICAGO
NEW YORK

Patent Notice: Cunningham tubes are covered by patents dated 2-18-08, 2-18-12, 12-30-13, 10-23-17, 10-23-17, and others issued and pending. Cunningham 40-page data book fully explaining care and operation of Radio Tubes now available by sending 10c in stamps to San Francisco Office.

Another Famous **TOWER**

Tower's

Scientific
LOUD-SPEAKER

\$8.50



It had to
be the **BEST**

We could have manufactured a loud speaker two years ago, but we wouldn't! We have waited—studying, planning, continually striving for perfection and now at last! WE HAVE IT—In the new TOWER'S LOUD SPEAKER. Surely a Wonderful TOWER Triumph.

The many features include, magnets that lift 2 lbs. 10 oz. diaphragm of specially constructed material, perfect non-vibrating horn, 10" bell.

TOWER'S phones are tested by Government Licensed Radio Operators. Weight only 8½ oz. On sale at all good dealers from coast to coast.



THE TOWER MFG. CORPORATION

98 BROOKLINE AVE. Dept. E, BOSTON, MASS.

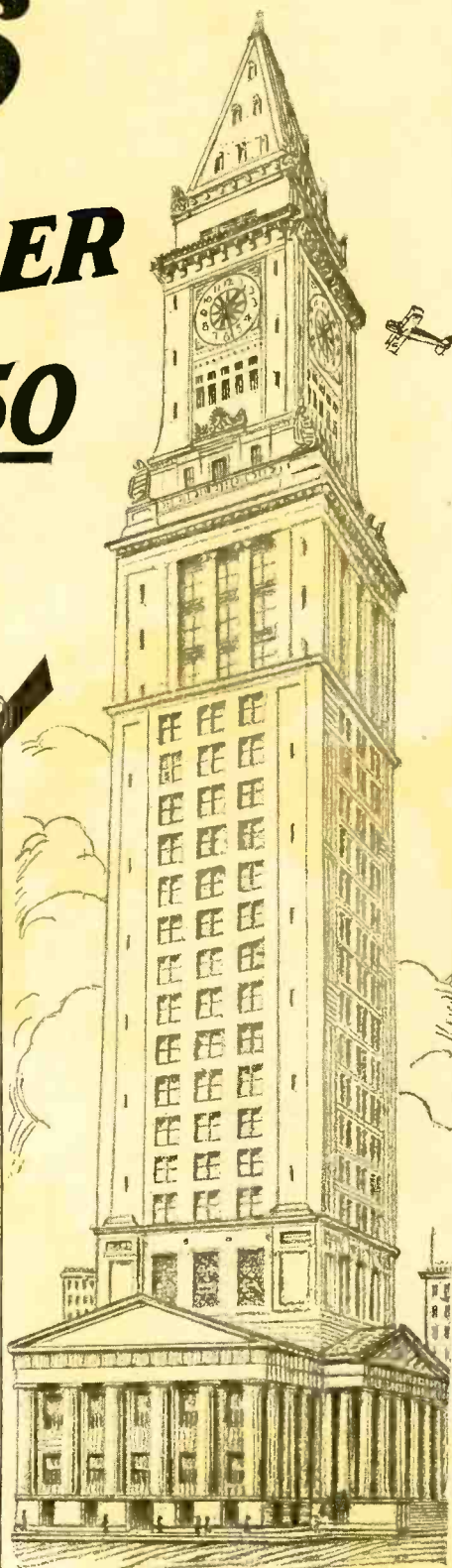

The U. S. Custom House Tower at Boston is 500 feet high and is situated in the business district overlooking Boston Harbor. It is the tallest Government building in America.

Worlds Greatest Loud Speaker Value

Tell them that you saw it in RADIO

RADIO

Established 1917

Published Monthly by the Pacific Radio Publishing Co.

ARTHUR H. HALLORAN, Editor

LAWRENCE MOTT,
Associate Editor

H. W. DICKOW,
Advertising Manager

Branch Offices:

New York City—17 W. 42nd St.
Chicago—157 E. Ontario St.
Boston—52 Irving St.
Kansas City, Mo.—1102 Republic Bldg.

Rates:

Issued Monthly, 25c a copy.
Subscription price \$2.50 per year
in the U. S., \$3.00 per year
elsewhere.

Entered as second-class matter at the Post Office at San Francisco, Calif.
Copyright 1925, by the Pacific Radio Publishing Co.

Correct Addresses:

Instructions for change of address should be sent to the publisher two weeks before the date they are to go into effect. Both old and new addresses must always be given.

Advertising:

Advertising Forms Close on the First of the Month Preceding Date of Issue.

Address all communications to

Pacific Radio Publishing Company

Pacific Building, San Francisco, California

VOLUME VII.

MARCH, 1925

NUMBER 3

CONTENTS

RADIOTORIAL COMMENT	9
RADIO IN THE ICEFIELDS OF THE CANADIAN ROCKIES	10
<i>By Lewis R. Freeman</i>	
RADIO ACTIVITIES ON THE CANADIAN NATIONAL RAILWAYS	13
<i>By W. H. Swift</i>	
A SELF-CONTAINED PORTABLE RECEIVER	15
<i>By Brainard Foote</i>	
BALANCED TUNED CIRCUIT RADIO FREQUENCY AMPLIFIERS	17
<i>By C. M. Jansky, Jr.</i>	
AN INEXPENSIVE HIGH-SPEED CHEMICAL CODE RECORDER	20
<i>By Harry W. Minnermann</i>	
A SECOND STEP OF RADIO FREQUENCY FOR THE TWO-TUBE REFLEX	21
<i>By E. C. Nichols</i>	
A KISS IN THE DARK	23
<i>By Oliver B. Scott</i>	
EXPERIMENTING WITH A LOOP	24
<i>By Harry A. Nickerson</i>	
AN IMPROVED LOOP ANTENNA	25
<i>By A. H. Vance</i>	
A LOW-LOSS, LOW-WAVE HELIX	26
<i>By G. F. Lampkin</i>	
AUTOMATIC RADIO TELEGRAPHIC RELAYING	27
<i>By Jack Bront</i>	
SHORT WAVE COUNTERPOISES	29
<i>By Gaston B. Ashe</i>	
MEXICAN RADIOCAST STATIONS	30
RADIOPHONE MODULATION CIRCUITS FOR THE RADIO NOVICE	31
<i>By L. R. Felder</i>	
ELIMINATING THE CW-PHONE SWITCH	33
<i>By Chas. F. Felstead</i>	
MEASUREMENT OF ULTRA-RADIO FREQUENCIES	35
<i>By Frank C. Jones</i>	
MODIFICATION OF BEST'S 45,000 CYCLE SUPER-HETERODYNE	37
<i>By Thomas L. Kennon</i>	
REBUILDING THE CR-9 FOR SHORT-WAVE RECEPTION	38
<i>By R. McGinnis</i>	
QUERIES AND REPLIES	39
WITH THE AMATEUR OPERATORS	41
CALLS HEARD	41
FROM THE RADIO MANUFACTURERS	42
RADIO GLOSSARY	74
<i>By Jack Bront</i>	
CONSTRUCTION HINTS	84

Forecast of Contributions for April Issue

A recent development in tuned radio frequency transformers, with their application in the Browning-Drake circuit is fully described by Volney D. Hurd. The article is illustrated by photographs, circuit diagrams and a picture circuit, enabling anyone to duplicate his results.

E. C. Nichols describes three circuits based on experiments with the single tube reflex. These simplify controls and apply the latest developments in tuned radio frequency amplification.

Frank C. Jones presents the results of some actual load tests of electrolytic and kenotron rectifiers.

As a fitting follow-up to his articles on harmonic transmission F. Dawson Bliley presents "A Transmitter That's Different."

Paul B. Findlay describes the Army's high power radio station at Fort Leavenworth, illustrating his story with some excellent pictures.

C. H. Campbell gives the details for a practical remote control system which is in successful use at 1 B M.

Alexander Maxwell tells how to build a one-tube short-wave loop receiver.

In the April issue will be published the first article in a remarkable series on audio-frequency transformers, constituting the most complete analysis of the subject ever published.

Ferd Humphreys illustrates and describes the construction of "An-A-Batteryless Audio Amplifier" utilizing 110 volt A. C. as the primary source of current supply.

D. B. McGown discusses "Harmonic Interference," its meaning, effect, and elimination in radiocast reception.

Harry A. Nickerson has some helpful ideas in his article on "Building Sets to Make Money," where time is the essence of success.

The new 20 K. W. tube set operated by the Army at Annapolis, Md., is illustrated and described by S. R. Winters.

James A. Ramsey has written an interesting account of the part radio is playing in education.

The fiction feature is "The Ether Garblers," a radio mystery story by Volney G. Mathison.

EVEREADY HOUR

EVERY TUESDAY AT 9 P. M.

For real radio enjoyment, tune in the "Eveready Group." Broadcast through stations

WEAF	New York	WFJ	Philadelphia
WJAR	Providence	WCAE	Pittsburgh
WEEL	Boston	WGR	Buffalo

*Dry "B" Batteries
are an economical,
dependable and
convenient source
of plate
current!*

There's more life in Eveready Batteries

BUY Eveready "B" Batteries and you get electricity in its surest, safest and most compact form. They reduce your operating expense. New developments in the Union Carbide and Carbon Research Laboratories, Inc., have been converted into new manufacturing processes in the Eveready factories. Good as they always have been, Eveready "B" Batteries are much better today.

The Eveready achievement of giving you more hours of "B" Battery service for less money has cut the cost of running receivers in half, and in some cases the new Evereadys make "B" Battery expense only a third of what it used to be.

There is an Eveready Radio Battery for every radio use.

Manufactured and guaranteed by
NATIONAL CARBON COMPANY, INC.
Headquarters for Radio Battery Information
New York San Francisco
Canadian National Carbon Co., Limited, Toronto, Ontario

EVEREADY Radio Batteries —they last longer



No. 7111,
1 1/2-volt
Dry Cell
"A"
Battery
for all
dry cell
tubes



No. 772.
45-volt
Large
Vertical
Price
\$3.75



No. 770.
45-volt
Extra
Large
Vertical
for heavy
duty
Price
\$4.75



No. 771.
4 1/2-volt
"C"
Battery
improves
quality,
saves "B"
Batteries
Price 60c

Tell them that you saw it in RADIO

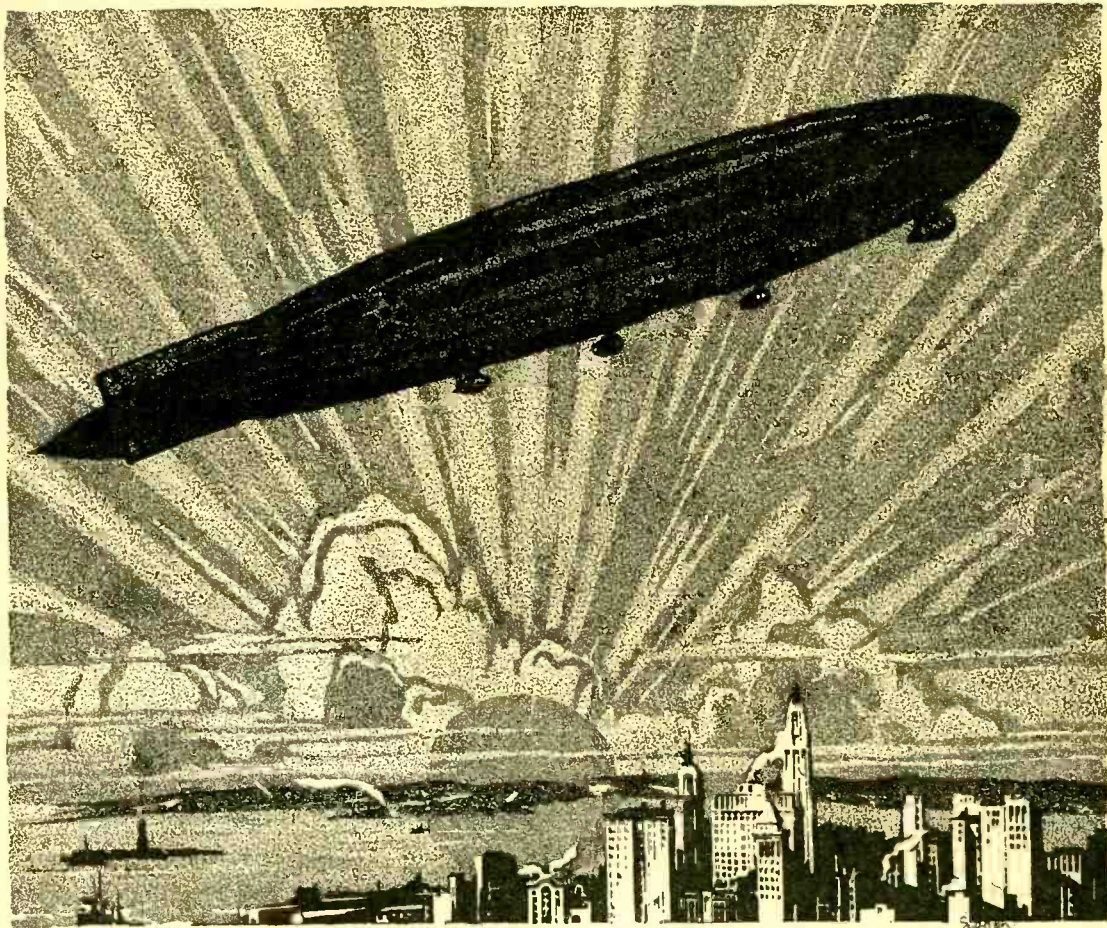

SHENANDOAH -- INDIAN WORD MEANING "DAUGHTER OF THE STARS"

When the "Daughter of the Stars" talks with the children of earth

YOU remember the dramatic night last winter when the giant Navy dirigible Shenandoah went adrift in a raging gale.

"You are over Newark," said radio station WOR. "What can we do to help you?"

Thousands of people sitting by radio sets in their cozy homes heard the plucky lieutenant - commander on the Shenandoah send back the reply: "Thanks, old man, everything's O. K."

In the air, as on the sea, radio equipment must be the most reliable it is possible to get. That is why the Shenandoah, the huge ship Leviathan

—in fact, many government and commercial radio plants—were equipped with Exide Batteries.

For your own set

When *you* use Exide Radio Batteries in your home you get the clearest reception, for Exides give uniform current through a long period of discharge.



The new Exide 6 volt "A" Battery in one-piece case.

There is an Exide type for every tube and a size for every set: "A" batteries for 2-volt, 4-volt and 6-volt tubes; "B" batteries, 24 and 48 volt, of 6000 milliampere hour capacity. They are efficient, dependable, long-lasting — and right in

price. Exide Batteries are made by the largest manufacturers of storage batteries in the world.

You can get Exides at Radio Dealers and at all Exide Service Stations. If your dealer should be out of booklets describing Exide Radio Batteries, send us your name and we will mail them to you.

THE ELECTRIC STORAGE
BATTERY COMPANY
Philadelphia

Exide Batteries of Canada, Limited
153 Dufferin St., Toronto

Exide

RADIO BATTERIES

FOR BETTER RADIO RECEPTION USE STORAGE BATTERIES

Tell them that you saw it in RADIO

ZENITH RADIO

They Cost More
But They Do More



*Super-Zenith VIII—
the ideal radio set
for the fine home*

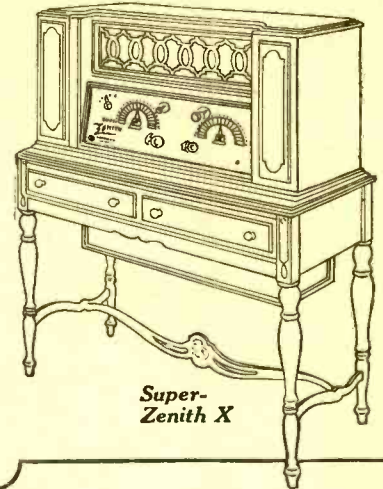

Super-Zenith X

To choose at will one glorious voice— one majestic symphony

A few blocks from your home a powerful station may be on the air. Other locals—six, eight or ten of them—may be broadcasting at the same time.

Imagine, now, the satisfaction of tuning them all out and bringing in distant cities. The air a chaos of sounds, yet out of that chaos, from across the continent, one glorious voice, one majestic symphony—the very program that you wanted most to hear—and as clear and appealing as though it were in the next room.

The ability to take your choice—that is what you want above all else in radio reception. And it is that very property, built into the Zenith, which makes it supreme among fine radio sets. The joy of possessing such an instrument is all the greater from the fact that its beauty of design and excellence of construction speak quietly of its distinction.

Before you choose the receiving set to occupy the place of honor in your home, be sure to see and try the Zenith. Its beauty you will recognize at a glance. Its extraordinary capabilities any Zenith dealer will be glad to demonstrate.

*Dealers and Jobbers:
Write or wire for our exclusive territorial franchise.*

ZENITH RADIO CORPORATION

332 South Michigan Avenue, Chicago

ZENITH—the exclusive choice of MacMillan for his North Pole Expedition

The complete Zenith line ranges in price from \$95 to \$550.

With either Zenith 3R or Zenith 4R, satisfactory reception over distances of 2,000 to 3,000 miles is readily accomplished, using any ordinary loud speaker. Models 3R and 4R licensed under Armstrong U. S. Pat. No. 1,113,149. They are NON-RADIATING.

Zenith 4R - - \$95

Zenith 3R - - \$160

The new Super-Zenith is a six-tube set with a new, unique, and really different patented circuit, controlled exclusively by the Zenith Radio Corporation. It is NOT regenerative.

SUPER-ZENITH VII—Six tubes—2 stages tuned frequency amplification—detector and 3 stages audio frequency amplification. Installed in a beautifully finished cabinet of solid mahogany—44½ inches long, 16½ inches wide, 10½ inches high. Compartments at either end for dry batteries. Price (exclusive of tubes and batteries) **\$230**

SUPER-ZENITH VIII—Same as VII except—console type. Price (exclusive of tubes and batteries) **\$250**

SUPER-ZENITH IX—Console model with additional compartments containing built-in Zenith loud speaker and generous storage battery space. Price (exclusive of tubes and batteries) **\$350**

SUPER-ZENITH X—Contains two new features superseding all receivers. 1st—Built-in, patented, Super-Zenith Duo-Loud Speakers (harmonically synchronized twin speakers and horns), designed to reproduce both high and low pitch tones otherwise impossible with single-unit speakers. 2nd—Zenith Battery Eliminator, distinctly a Zenith achievement. Requires no A or B batteries. Price (exclusive of tubes) **\$550**

Price (without battery eliminator) \$450
All Prices F. O. B. Factory.

ZENITH RADIO CORPORATION, Dept. H-3
332 South Michigan Avenue, Chicago, Ill.

Gentlemen: Please send me illustrated literature giving full details of the Super-Zenith.

Name.....

Address.....

A Message FROM MARS

THE possibility of radio communication with Mars is doubtful but the merit of the Rectigon battery charger is a certainty.

Tune up your radio batteries with the Rectigon. Keep the A and B batteries of your set in constant readiness to receive distant stations.

The Rectigon charges radio batteries over-night at less than one-tenth of the price paid for the same service at the battery station.

It charges Automobile batteries, too.

The Rectigon weighs only a few pounds and is no more trouble to install than a light bulb. Send for folders F-4584 and F-4585, they are revelations on battery charging.

Westinghouse Electric & Manufacturing Company
George Cutter Works, South Bend, Indiana
Sales Offices in All Principal Cities of
the United States and Foreign Countries



Westinghouse



What Reliable Radio Means to You

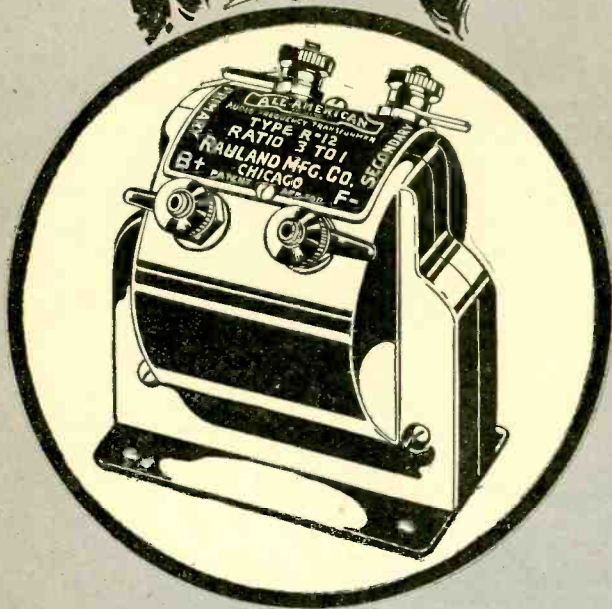

☞ An assurance that, when you try out a hook-up, you can rely on your instruments to give you a fair test. ☞ A knowledge that each part has been put to such searching tests that its proper performance, under any conditions, is assured. ☞ In short, a conviction that each individual part will continue to do its work year after year.

Two pleasant hours spent with the RADIO KEY BOOK will acquaint you with the essential facts of modern reception, and how to enjoy it at its best. Ten cents—coin or stamps—brings the KEY BOOK.

RAULAND MANUFACTURING CO.
PIONEERS IN THE INDUSTRY
2654 Coyne Street - - - Chicago

ALL-AMERICAN Guaranteed Radio Products

Standard Audio Transformers
3 to 1 Ratio, type R-12... \$4.50
5 to 1 Ratio, type R-21... 4.75
10 to 1 Ratio, type R-13... 4.75

Power Amplifying Transformers
(Push-Pull)
Input type R-30... \$6.00
Output type R-31... 6.00

Rauland-Lyric
A laboratory grade audio transformer for music lovers. R-500... \$9.00 

Universal Coupler
Antenna coupler or tuned r. f. transformer. R-140... \$4.00

Self-Tuned
R. F. Transformer 
Wound to suit the tube. R-199 \$5.00. R-201A \$5.00

Long Wave Transformer
(Intermediate Frequency)
(15-75 kc.) R-110... \$6.00

10,000 Meter (30kc.)
Transformer 
Tuned type (filter or input). R-120... \$6.00

Radio Frequency Coupler
(Oscillator Coupler). R-130 \$5.00

Super-Fine Parts
Consisting of three R-110's,
one R-120 and one R-130 \$26.00 

All-American
Reflex
Receivers 
Complete receiving sets with extraordinary range, volume and selectivity. All parts mounted on panel and baseboard, with full instructions for wiring. All-Amaz Junior (one-tube)... \$22.00
All-Amaz Senior (three-tube) \$42.00

ALL-AMERICAN

Largest Selling Transformers in the World

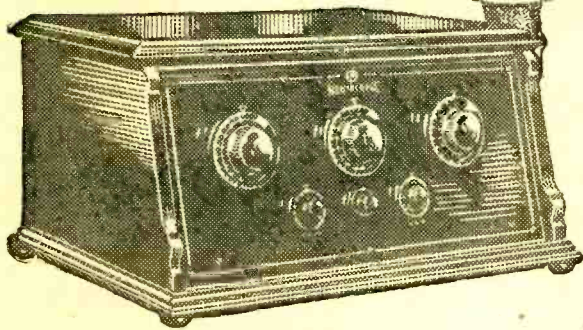

If Mozart could hear "*The Magic Flute*" on a FADA Neutrodyne

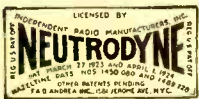

—his trained ear would approve the tonal fidelity to the original in his famous old opera. The peculiar charm of this woodwind instrument is caught in all its purity by the famous Fada Neutrodyne. With equal tonal truth, Fada reproduces the deep rolling bass of the pipe-organ.

The Fada Neutrodyne has the range of the 88-key pianoforte. McCormack's pure tenor, Bori's delicious soprano, create the illusion of standing beside the actual artists when you hear them on a Fada set. Bass and baritone voices are reproduced with equal fidelity. Nor does Fada create those raucous distortions that have kept many discriminating folks from investing in radio.

Fada selectivity is one of its chief charms. Turn the dials to predetermined numbers, and in rolls the very station you want to hear—provided the waves from that station are reaching your neighborhood. Fada also excels in distance and volume. In short, Fada is radio at its very, very best.

There are six models to meet every taste and pocketbook. \$75 to \$270. Fada is adapted to either dry-cell or storage-battery tubes, and either indoor or outdoor aerial. Hear Fada. It will be a revelation in radio! Buy your Fada now and be ready to hear the world's famous artists whenever they sing or play for you over the radio.

FADA Radio

F. A. D. ANDREA, INC.
1581 JEROME AVENUE, NEW YORK

RADIO

Established 1917

Volume VII

MARCH, 1925

Number 3

Radiatorial Comment

RADIATIONS from faulty electric power lines or equipment constitute an elusive, annoying and widespread source of interference to pleasurable radiocast and code reception. They are elusive because they may vary with weather conditions and are often difficult to locate, especially if coming from some part of a system miles away from the fault actually producing the disturbances. They are annoying, not alone in making reception disagreeable, but also because their correction usually lies beyond the ability of the listener. They are widespread because liable to occur wherever power lines go.

The trouble is not due to the receiver, which is merely performing its normal function of detecting radiations, but to the electric power system, whose function is to transmit or utilize power and not to radiate it. These radiations are not caused by the useful sixty-cycle current, which is comparatively inaudible and not easily radiated, but by high frequency oscillations produced by arcing grounds, leakage over defective insulators, or anything else causing an electric spark discharge.

While they represent a greater or less waste of energy their main objection, from the power company's viewpoint, is the possibility of a future break in the continuity of service. Their occurrence is a danger signal which it is to the company's self-interest to investigate.

But of far greater significance than this physical break is the danger of a break in the continuity of friendly relation with the public. No one can feel friendly to a company whose equipment is a constant source of annoyance. The \$75,000,000 additional annual revenue which radio has brought to the power companies through battery charging and later hours of home lighting is but a drop in the bucket when compared with the public good-will which is thus being seriously jeopardized.

Most power companies are fully alive to this situation, although a few still inform complainants that they are not interested. But knowing of a situation and taking active steps to correct it are two entirely different matters. Some of the companies have made more or less half-hearted efforts to locate trouble after it has been called to their attention but, so far as we are informed, none have taken the initiative in finding these faults before complaints are registered.

It is no more difficult for a power company to know of this interference than for a consumer to be annoyed by it. A sensitive radio receiving set in each district office, substation and power plant will give notice as soon as defects occur and a crew can be sent out to remedy them at once. The expense of this would be negligible in comparison with the value of the good-will thus preserved, especially if the power company lets it be known that sincere efforts are being made to locate and prevent such interferences. Furthermore the company would have facts instead of surmises to answer many complaints of interference which are not caused by their equipment.

There are admittedly many difficult technical problems to be solved before all of these undesirable radiations can be eliminated. This is a task for the radio engineers, at least one of whom should be employed by every large power company. A great deal of helpful information is already available in connection with the elimination of the somewhat similar inductive interference of power lines with telephone lines. Much of it can be applied with profit to the present problem.

A suggestion for alleviating the trouble has been made by Colonel J. F. Dillon, supervisor of the sixth radio district, who has given much thought to this problem as well as that of radiations from the electrical precipitators used at smelting and cement plants. He suggests that resonant circuits be installed at convenient points along the line to drain off any high frequency currents. While this may be feasible for lines devoted solely to their prime purpose of power transmission it may cause difficulty on lines where "wired radio" is used. But even then their prime purpose should be paramount.

Heretofore there has been much talk but little action. The time has come for the power companies to act voluntarily. The public is long-suffering, but patience sometime ceases to be a virtue. Unless corrective action is soon taken some astute politician will ride into office on a slogan of non-radiating power lines, his support coming from thirty million irate radio fans.

Finally the Federal law definitely forbids transmission without a license. It is beyond the realms of belief that any power company can secure a license to maintain a public nuisance!



Ready to Listen In at the Arctic Divide

Radio in the Icefields of the Canadian Rockies

A Remarkable Account of Reception Under Difficult and Unusual Conditions

By Lewis R. Freeman

IT is always interesting to try out a new and developing invention under fresh and hitherto untried conditions. When I sought advice in Chicago and New York last summer as to the chances of its proving worth while to take a radio set with an exploring expedition which I was about to accompany to the icefields of the Canadian Rockies, expert opinion was far from encouraging. Several of the high-power stations reported that, having had practically no authentic

records of having been picked up in the mountain regions of western Canada, they were inclined to believe that conditions were not favorable to radio reception. Eastern Canadian stations reported to much the same effect. The charts showing places at which they had been heard were practically blank beyond the wall of the Rockies.

While admitting that this might be due to the fact that few if any radio sets had been taken into the high Rockies, the consensus of opinion was that the only sets likely to be successful would have to be very sensitive, and in the hands of experts. When I explained that the region to which we expected to penetrate could only be reached by taking a pack-train through trackless timber, up and down flooded valleys and (in at least one instance) across the arm of an extensive icefield, they were a unit in declaring that the type of set which they believed would be needed to get any real results would not survive the first day's packing.

The experts were proven by the sequel to have been both right and wrong. They were right in their belief that none of the highly sensitive sets, cumbersome yet delicate as they were, could withstand the all but annihilative roughness of pack-horse travel. But they were equally wrong in believing that a light, simple and comparatively easily protected radio set would not be technically equal to receiving in the high Rockies

stations from all parts of the United States and Canada.

Such a set brought results beyond all expectations. Indeed, it is open to question if a small set of this character, operating under the most favorable conditions in the heart of the United States, could have done any better, either as to distance or quality. If this is true, it would seem to indicate that, far from being a "dead" area, the icefields of the Canadian Rockies and the region surrounding them are exceptionally favorable for radio.



Reception from Horseback

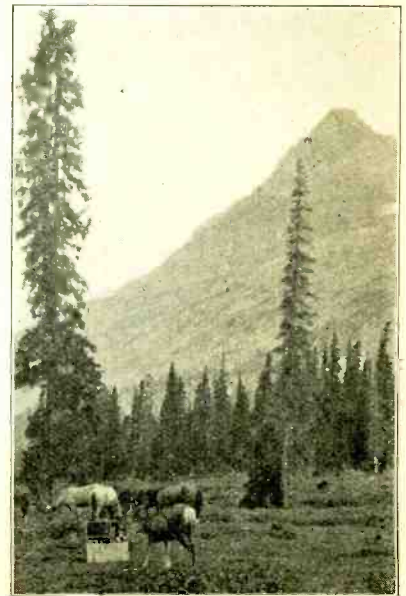

Where Even the Deer Are Tamed by Radio



Logging A Concert From San Francisco

The set in question was a Radiola III-A, weighing but a few pounds. A stout oblong box, built to swing to one side of a pack-saddle, was constructed in Banff. One compartment held the radio, another the dry batteries, all connected up, and a third spare parts. The total weight of the loaded box was about 60 pounds. This was balanced on the other side of the horse with a grub-box. A bag containing the insulated wire for the aerial rode between the boxes, with a cage containing our carrier pigeons crowning the load.

A preliminary trial of the radio before starting out from Lake Louise was fairly encouraging. During the next week, however, the set was so badly banged in working the pack-train through fallen timber, and so thoroughly soaked in fording swollen rivers, that we gave up all hope of ever putting it in action again. It was with no little surprise that a very hurried and imperfect set-up at Bow Lake proved that there was not only life in the radio but in the air as well. Nothing came in very satis-



Taking Radio to the Top of the Continent

factorily, however, unless we except several deer that filed down where the horses had been salted the night before. One of the does I snapped in the very act of sniffing the radio. As we were confident the fault was in the very hastily strung aerial, we were far from discouraged that reception was not clearer.

roughest mountain on the North American continent. In taking the outfit down five miles of the great Saskatchewan Glacier, an attempt was made to save the radio by carrying it lashed to a rough sledge. This worked fairly well as long as a man could be spared to draw the clumsy contrivance, but when we all had to give our attention to the horses there was nothing to do but harness our huskie to the sledge. "Buster's intentions were good, but when a rock rabbit chirruped from its nest in the medial moraine instinct rose superior to training. Luckily it was a very narrow crevasse that "Buster" hurdled in his flying assault, else we would have needed something longer than an alpenstock to fish the radio box and sledge up from the bottle-green depths.

The radio box was restored to its horse at this juncture, to be almost crushed when that unlucky animal was caught between two sliding fragments of granite where we were working the pack-train off below the snout of the glacier.

The next day we crossed the divide to the head-waters of the Athabasca and



Across the Ice Fields by Sled

made camp at timber-line close to the side of the glacier of the same name. Here, on the Arctic side of the continental divide, with a score of thirteen thousand-foot-high peaks and the whole hundred and fifty square miles of the great Columbia Icefield intervening between us and civilization, the radio came fully to its own. KDKA of Pittsburg, especially with its late programs, came in with the greatest clearness, as did also KFKX of Hastings, CKAC of Montreal, KGO of Oakland, CKCD of Vancouver, and scores of intermediate stations. The high-power stations we soon came to pick up almost at will irrespective of the weather, though Hastings was somewhat elusive until a change of wavelength made it almost as dependable as our main stand-by, the powerful KGO. The latter was a source of never ending pleasure. Time and again we could pick it up with stock reports in the twilight of the long summer days, and hold it right on through to the final signing-off without the loss of a word. We had a complete opera rehearsal broadcasted from San Francisco by KGO, and so clearly that I recognized the voice of the special announcer of the evening as my old friend, Charley Field, of *Sunset Magazine*. I also recognized without difficulty the voices of friends speaking and singing over KHJ and KFI of Los Angeles.

Our best radio conditions were during the month that followed, when we were camped close up against the Columbia icefield, with its lofty 9-000-foot barrier of perpetual snow and ice intervening between us and the various founts of radio to the south. Here the most delicate nuances of expression were audible, sometimes even the breathing of a singer. Our wrangler, listening to "Sing me to Sleep," lying in bed with the receivers over his ears, actually dozed off and slept until awakened by a spark from the tepee fire.



"The Thermometer Touched 115 Degrees Today at Fresno, California"



A "Broadcast" Receiver from a Bucking Pack Horse

On the utility side probably our most valuable service was that of the Weather Bureau, broadcasted every evening by KGO. This warned us of the approach of three general storms from the northwest, enabling us to hasten or defer important photographic work that depended upon fair weather. Two of the members of the party holding stock listed on the San Francisco and New York exchanges were able to follow them by the KGO announcements. A conditional order to a broker, based on information thus received and sent out by carrier pigeon to be mailed from Banff, was subsequently executed with profit. Another carrier pigeon letter, to Walter Woehlke of *Sunset*, San Francisco, was duly replied to in a statement read by Joseph Jackson, Literary Editor of the same publication, through the courtesy of KGO.

It is a matter of regret that we were

too busy to attempt much in the way of daylight reception while still in this zone of ice and clear air where the conditions were so favorable. Our only serious attempts in this line were made a month later at Maligne Lake, at a much lower elevation. Here we had in daylight parts of the speeches of General Pershing and Secretary of War Weeks, in connection, I believe, with the Defense Day program. We also had parts of Hoover's speech to the Radio Congress in Washington, broadcasted from KGO. Neither of these tests were carefully prepared for, or am sure the results would have been much better.

When the broadcasting of the play-by-play progress of the World's Baseball Series came on early in October we were in the midst of a bitter fight with heavy winter snows of the high passes between Jasper and Banff. Busy with pack-horses struggling in belly-deep snow by day and too tired at night more than to get up the canvas to keep out the cold that went at one time down as far as ten below zero, we still contrived enough hasty and improvised string-ups of the aerial to follow the sequence of the games. One of these, with the wire run between the side of a glacier and a dead tree, with the radio still in its pack-box on the horse, brought in the news of several plays of the epic final game which clinched Washington's victory.

First and last, then, it will be seen that the radio, besides being infinitely entertaining, also proved an article of considerable utility. It was a real pity, of course, that the expedition did not include anyone with the least technical knowledge of radio. What were evidently Morse code signals of great strength came in repeatedly when we hooked up the instrument in the afternoon, but there was none among us with sufficient intelligence to puzzle out from whence they came.

Radio Activities on the Canadian National Railways

An Illustrated Description of Their Nine Radiocast Stations and Receiving Equipment on Trains

By *W. H. Swift, Jr. Radio Engineer, Canadian National Railways*

RADIO as a definite part of the service offered to the community by a transportation system, may, perhaps, seem rather a visionary project, yet, so far as the Canadian National Railways are concerned, it is not in the mere experimental stage, or offered as an amusing plaything, but is seriously and definitely in daily use as one of the factors considered necessary for the convenience of the travelling public. The Canadian National Railways' radio department is now as truly a part of the system as those concerned with operation, traffic, express, telegraph, lands and colonization. Furthermore, this is the first railway system in the world to adopt radio as part of the regular service of transportation.

It was during the early summer of 1923 that radio on the Canadian National Railways really came into being, after a number of years of interesting experiments. A party of influential citizens from New York and New Jersey were on their way across Canada on a

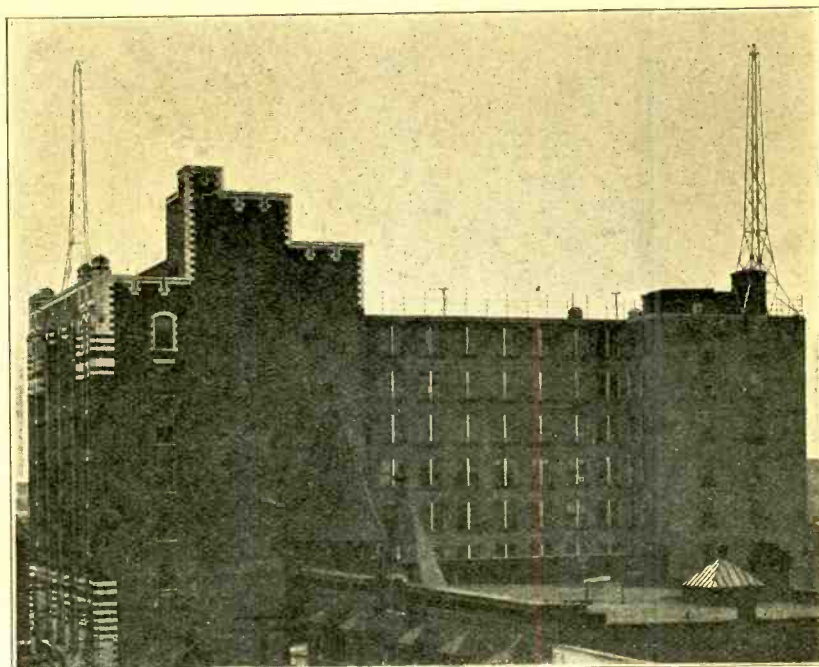

Aerial at CNRO, Ottawa, Canada, 187 Feet Above the Street

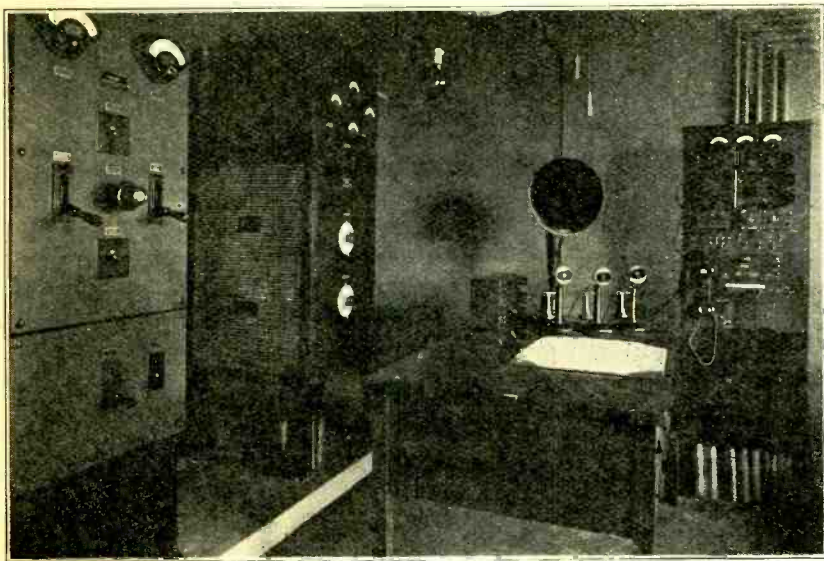

Operating Room at CNRO, 435 Meters

special train. It was decided, as a novelty, to radiocast to them a message of welcome to the Dominion as their train left Montreal and to tell them something of the scenic treats in store on their westward journey. The observation car of their train was fitted with a receiving set and W. D. Robb, vice-

president of the road, who is keenly interested in radio from a scientific standpoint, delivered the address into the microphone. The experiment was successful beyond all anticipations and in that moment the radio service of the Canadian National Railways was born.

It was left to Mr. Robb to organize

the department and to develop the general line of policy to be followed. He gathered about him a group of radio engineers after which the active work was planned and carried out. Negotiations were entered into with companies in Montreal already operating radiocast stations, several trains were equipped with receiving sets, and on New Years Eve, 1923, the radio program of the Canadian National Railways became an

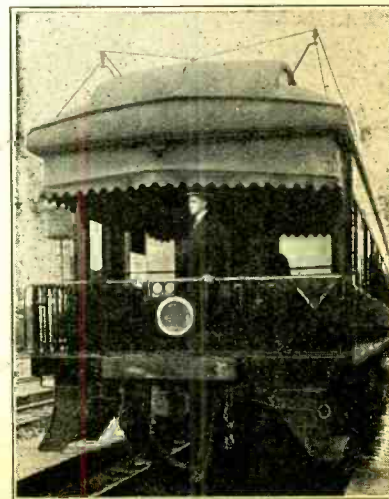

Aerial on C. N. R. Car

established fact with a radiocast from Montreal. Speakers on that occasion were: Sir Henry Thornton, K. B. E., chairman and president; Messrs. S. J. Hungerford, J. E. Dalrymple and W. D. Robb, vice-presidents.

The next step was the erection of a radiocast station in Ottawa. This was carried out by the staff of the Canadian National Railways and in a few months Ottawa, the Capital of Canada, became the site of the most powerful station in the Dominion. Then followed the establishment of other links in the chain. One by one, stations were added at Winnipeg, Regina, Saskatoon, Calgary, Edmonton, Toronto, Moncton, and by the time this article appears in print we hope

hotels of the system also have receiving sets.

At this point it will not be amiss to say something of the type of stations and their equipment, taking Ottawa as one example. Station CNRO is located on the roof of the Jackson Building, Ottawa's most pretentious office building, with the studio on the first floor. The Jackson building is 112 ft. high, with aerial towers rising another 75 ft. above the roof, thus giving the station command of the highest point in the Capital. The Jackson building is a modern, reinforced concrete structure, the roof area being approximately 100 by 200 ft. This made possible the erection of specially galvanized steel tow-

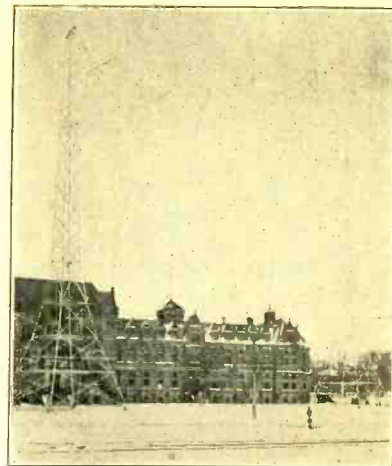

Aerial at CNRA, Moncton, N. B.



Operating Room at CNRA, Moncton, N. B.

ers, which were built at diagonal corners. The height available for aerial suspension is 187 ft., and the aerial is of four strands, each strand being approximately 155 ft. long. The operating and power rooms were placed in adjoining independent brick structures, at the base and to the left of the rear tower, thus enabling the lead-in from the aeri- als to be brought directly to the operat- ing room with an almost perpendicular drop. The operating room is 10 by 12 ft., and the power room 9 by 12 ft., with brick walls and partitions, and with approximately 11 ft. of head room. They are reasonably sound proof.

The studio consists of a room on the first floor of the building and is 22 by 25 ft. The walls are covered with a heavy light blue rep and the floor covering is of an extra quality dark blue Wilton car-

Continued on Page 52

a station will be in operation at Vancouver, so that the company is in the position of being able to radiocast east and west across Canada at will, a stretch of nearly four thousand miles from the Atlantic to the Pacific.

During the period of growth and development of the radiocast chain, the work of equipping trains with radio receiving sets was not being neglected. Difficulty was experienced at first in obtaining the types of sets necessary for the successful reception of programs on board a moving train, but this difficulty was eventually overcome and today all of the sixteen transcontinental trains needed for the eastward and westward daily movement of passengers between Montreal and Vancouver, have been equipped with receiving sets. Trains operating between Montreal and Quebec have also been equipped as well as "The National," which is operated between Toronto and Winnipeg. Eventually every important train on the system will have radio receiving sets. These sets are placed in the compartment-observation cars on the transcontinental route and on the parlor-library cars of the Montreal-Quebec trains. The equipment includes a number of individual headphones as well as loud speaker. All



Radio-Equipped Observation Car

A Self-Contained Portable Receiver

A Four-Tube Reflex With Loudspeaker. Loop and Batteries Compactly Housed in a Suit-Case

By Brainard Foote

A set that is really portable and that will operate a loudspeaker from a small loop can be assembled in a suit-case by adapting a four-tube reflex circuit to the requirement. This has three stages of radio frequency amplification reflexed with three stages of audio in the first three tubes and uses the fourth tube as the detector.

Of course, you'll be obliged to do a bit of testing with transformer connections and fixed condenser capacities should you tackle this outfit, but trials I've made with several different makes of both R. F. and A. F. transformers clearly demonstrate that results are uniformly good when the by-pass condensers are rightly inserted and the audio transformers connected in correct polarities. Therefore I'm not going to recommend special makes of apparatus—this being unnecessary. All you need are

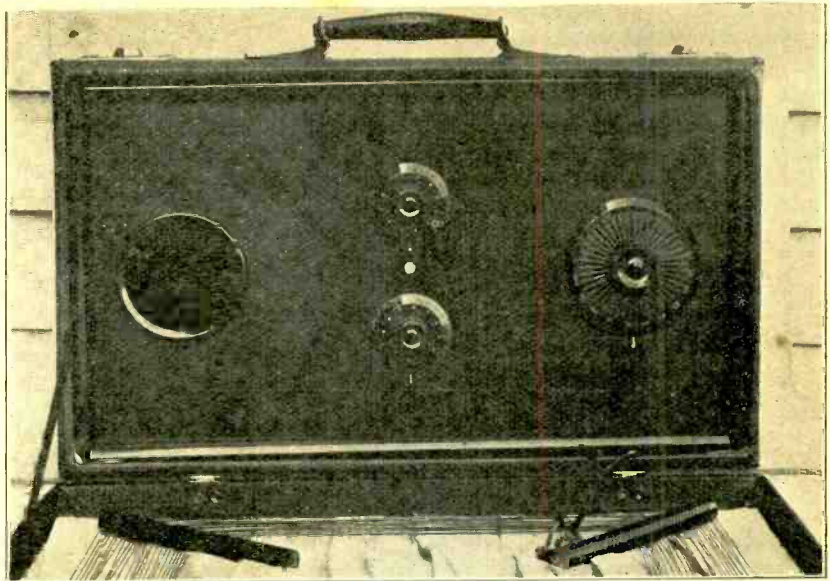

Panel View of Portable Receiver Showing Horn Aperture and Dial Controls of Potentiometer, Rheostat and Tuning Condenser

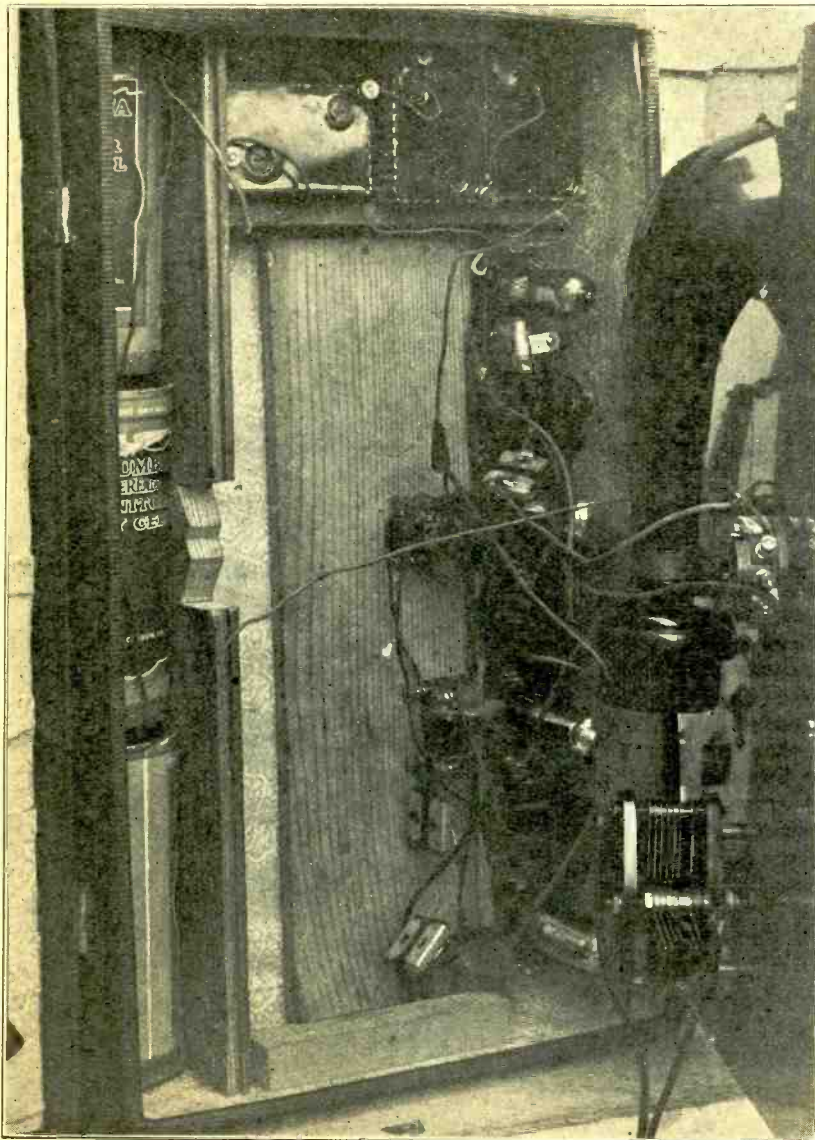

Inside View of Portable Receiver

good instruments that work satisfactorily in any circuit. Here's what you need:

- 1 Suit-case, app. 21x11x6½ ext. diam.
- 3 R. F. iron-core transformers.
- 3 Audio transformers, low ratio.
- 4 C-299 or UV-199 tubes.
- 4 Sockets for the tubes.
- 1 Rheostat, 15 to 20 ohms.
- 1 Potentiometer, 400 ohms.
- 3 Small 22½ volt B batteries.
- 3 Standard dry cells.
- 1 Panel to fit suit-case.
- 1 Phone unit of high quality.
- 1 Small horn for speaker.
- 1 Variable condenser, about 17 plates, (.00035).
- 2 ft. of insulating rod for loop (about ⅝ in. diam.)
- 1 .00025 mfd. grid condenser with grid leak clips.
- 1 2-megohm grid leak.
- Quantity bell wire for connections.
- Dials for above instruments.
- 2 .002 mfd. fixed condensers.
- 1 .001 mfd. fixed condenser.
- (Other fixed condensers; see below).
- One-fourth lb. No. 22 DSC wire.

All of the fixed condensers cannot be definitely specified because of capacity differences between primary and secondary windings of various audio transformers with which they are used as by-pass devices. If you have two of the .00025 mfd. size, an extra .001 mfd., and one .0005 mfd., you will be sufficiently equipped to determine the proper combination.

If your suit-case is at least 19 inches long (inside) the three dry cells will go end to end at the rear. After first constructing the receiver with the batteries at the front, I discovered that results were poor simply because of coupling between the loop and the R. F. transformers and wiring. Hence it was necessary to adopt the assembly shown, which is really better because the loca-

tion of the dry cells at the rear makes the carrying qualities better.

A narrow board serves as the wall of the *A* battery compartment and if necessary, a piece is cut out to clear the potentiometer. The *B* batteries are located across one end, two being placed parallel with the front of the suit-case and the other turned, if necessary, to clear the loud speaker horn. These separator strips are nailed in with small flat-head wire nails from the outside. The heads of these nails may be blackened for concealment. The amplifier itself is separately mounted on a thin board that is held in position with a flat-head wood screw introduced from outside the bag. The wiring is done before this board is put in the case.

The panel lay-out is quite simple. The aperture for the bell of the loud-speaker horn is placed to balance with the large dial for the tuning condenser, but with due regard for clearance within, and also above. Since the phone unit most conveniently comes at about the center of the panel, or the under side, the potentiometer and rheostat are mounted mid-way and on either side of the longitudinal center-line.

The loop must also be considered while the panel is being placed. It will be observed that the "legs" of the loop are so placed that they lie very close to the panel when the cover is closed and at such angles that they do not touch the horn or any of the dials. They are formed of 6 in. lengths of insulating rod, each being fastened by a machine screw passed through from the outside and into a tapped hole at the center of each rod. Moreover, the rods do not extend up into the corners of the cover, for they would then strike the corners of the case itself and prevent closing.

Measuring about 16 by 10 in., the loop shown requires 25 turns of wire to cover the radiocast band from 220 to 570 meters with the condenser suggested.

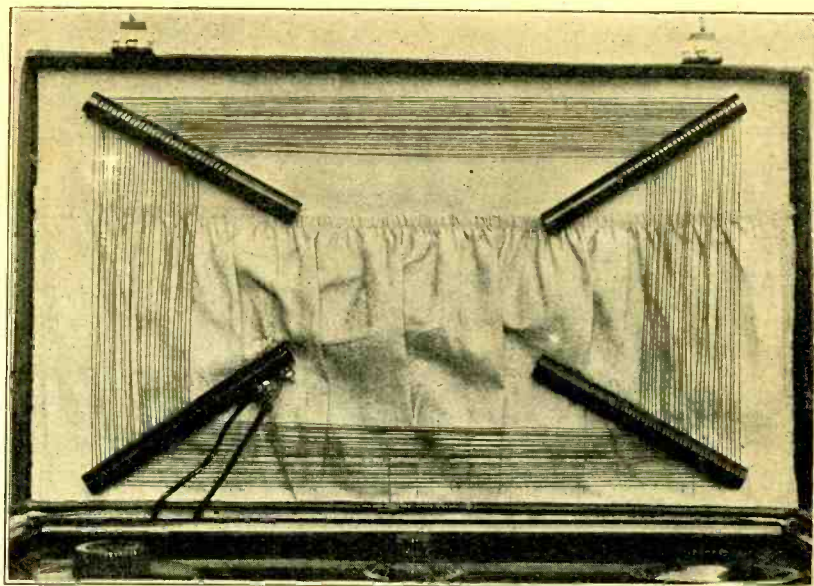

Loop Construction in Suit-case Cover

It is well to wind too many turns on the forms and then remove the extras until the condenser just covers the desired wave band nicely. Thirty turns were put on in the first place. The wire used is number 22 DSC and is attached to two binding posts at the lower left. It is held in slanting slots about one-fourth in. deep and one-eighth in. apart.

The circuit diagram shows that the R. F. transformers are connected in accordance with the manufacturers' designations. It is to be observed that the grid return lead from the first tube only goes to the movable contact of the potentiometer—the others running direct to the negative of the *A* battery on the battery side of the rheostat. In case of persistent oscillation even without by-pass condensers on the secondary windings of the second and third audio transformers, it will be necessary to place grid return leads from these transformers on the movable contact also. But this is seldom the case. The first tube oscillates persistently with the full negative bias,

however, simply on account of the lower resistance and sharp tuning of its grid circuit: the loop.

It is best to start off by connecting the audio transformers according to manufacturers' markings with the exception of the third transformer's secondary. This is reversed, as indicated. The "low voltage" or filament side of by-pass condensers may be run to the nearest point on the filament circuit, either to the plus or minus side. It is important to get the grid return ("F") lead from the third R. F. transformer on the plus filament. The by-pass condensers serve to pass radio frequency current across the high impedance windings of the audio transformers and they therefore should be placed so that the radio frequency paths are as short as possible. For instance, by-pass condenser *C*₁ should run from the *B* post of the first R. F. transformer to one side of the filament; they are shown across the transformer windings to bring out

Continued on Page 68

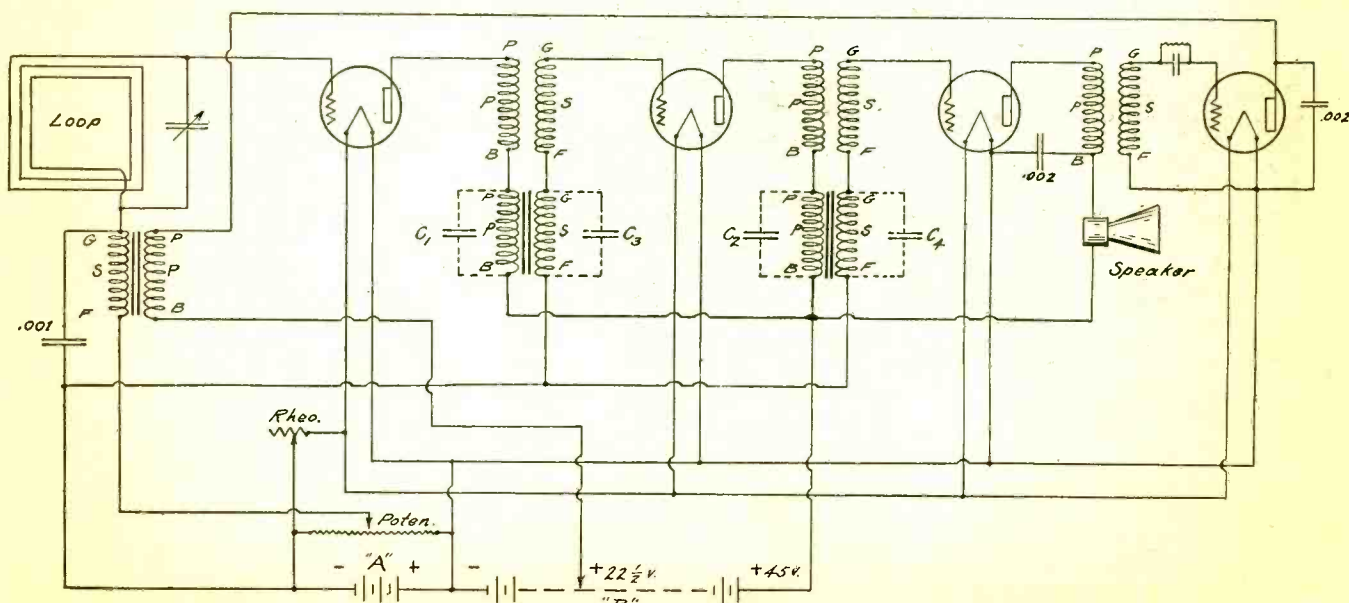

Circuit Diagram for Reflexed Triple R. F. and A. F. with Crystal Detector

Balanced Tuned Circuit Radio Frequency Amplifiers

An Explanation of the Principles of the Neutrodyne and Other Methods of Obviating Oscillations

By C. M. Fansky, Jr.

IN January RADIO we discussed why a radio frequency amplifier using tuned circuits of low resistance will tend to produce strong radio frequency oscillations unless some means is taken to control the regeneration inherent in the system. This regeneration as has been stated is due to the feeding back of voltage through the grid plate capacitance of the tube. Fig. 1 shows such a circuit. We have discussed methods by which this tendency to oscillate can be controlled by deliberately inserting resistance into the radio frequency circuits.

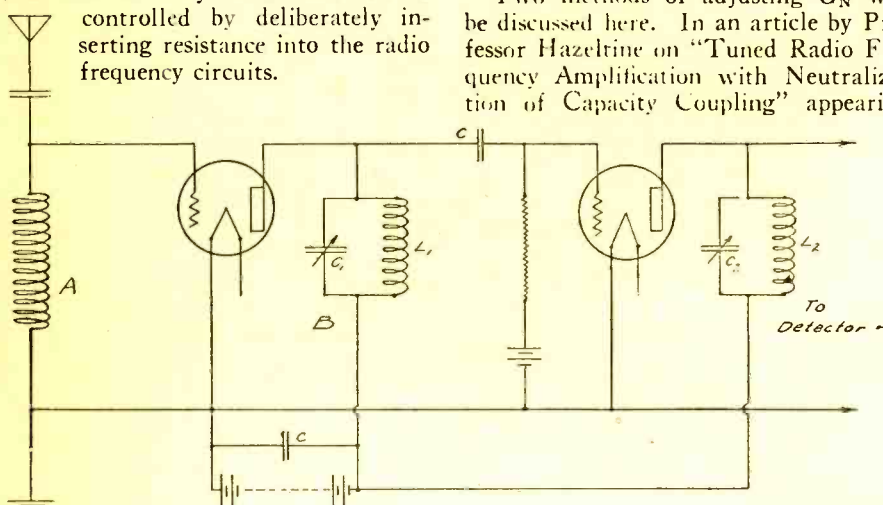

Fig. 1. Theoretical Tuned Circuit Radio Frequency Amplifier

Another method of controlling regeneration is to produce on the grid a voltage which will offset the regeneration effect produced by the voltage across the grid plate capacitance of the tube. Such circuits are often called neutralized or balanced circuits. The trade name neutrodyne is also applied to certain types.

Fig. 2 shows a circuit of this type which is much used in commercial sets. The circuit shows two stages of radio frequency amplification. A complete commercial set would ordinarily require 5 tubes as it would contain in addition a detector and two stages of audio frequency amplification. L_1 and L_2 constitute a radio frequency transformer. Sometimes more turns are put on the secondary than on the primary in an effort to step up the voltage. However, due to leakage flux and losses, it is difficult to build a radio frequency transformer which has a voltage ratio greater than unity. It is essential that the coupling between L_1 and L_2 be very close if satisfactory regeneration limitation is to be obtained. The transformer L_3 and L_4 is identical with the one composed of L_1 and L_2 .

The condensers C_N are connected to

the secondaries of the radio frequency transformers which are wound in such a direction that the radio frequency voltage produced across C_N will be 180 degrees out of phase with that of the radio frequency voltage across the plate grid capacitance of the tube. C_N is of very small capacitance and is usually made variable in such a manner that when the correct adjustment is obtained the adjustment can be locked.

Two methods of adjusting C_N will be discussed here. In an article by Professor Hazeltine on "Tuned Radio Frequency Amplification with Neutralization of Capacity Coupling" appearing

the voltage of the grid with respect to the filament. If the capacitance of the condenser C_N is increased beyond the point necessary to completely eliminate the incoming signal the voltage induced on the grid will tend to destroy any amplification resulting from the use of a tube.

It is not necessarily desirable to completely neutralize the effect of regeneration as has been described above. Stronger signals will be obtained with the same number of tubes if the capacitance of C_N is increased only to the point where the amplifier ceases to produce radio frequency oscillations. The regeneration remaining will also tend to increase the selectivity of the system. If too much regeneration remains distortion may result from excessive selectivity or other reasons. The writer is not concerned with the debatable question as to whether or not the manufacture or sale of a radio frequency amplifier in which the effects of regeneration are not completely eliminated is covered by patents which control regeneration but only with questions as to the relative advantages of amplifiers in which regenerative effects are completely eliminated and those in which regenerative effect exists.

The statement has been made that it takes about one and one-half stages of non-regenerative radio frequency amplification to deliver as strong a signal to a detector tube as can be obtained by the use of a regenerative detector circuit connected directly to the aerial. Such a statement is of course only a rough approximation but expresses the fact that if non-regenerative radio frequency amplification is used as a substitute for regeneration, more than one stage must be used if any increase in signal strength is to be expected and then the results may not be what the experimenter might expect from the cost of the additional equipment necessary to add the radio frequency amplification. If, however, the radio frequency circuits are carefully de-

in QST April, 1923 he states:

"The adjustment of each neutralizing capacity is made experimentally by tuning in a strong signal and then turning out the filament of the tube whose capacity is to be adjusted, but leaving the tube in the socket. If the neutralizing capacity is not correct the circuits on each side of the tube will have capacity coupling which will transmit the signal. The neutralizing capacity is then adjusted until the signal disappears."

This method of adjustment was developed by Mr. Harold A. Wheeler. It is quite evident that if a radio frequency amplifier circuit is adjusted by this method no regeneration exists, as radio frequency variations in the voltage of the plate with respect to the filament produce no radio frequency variations of

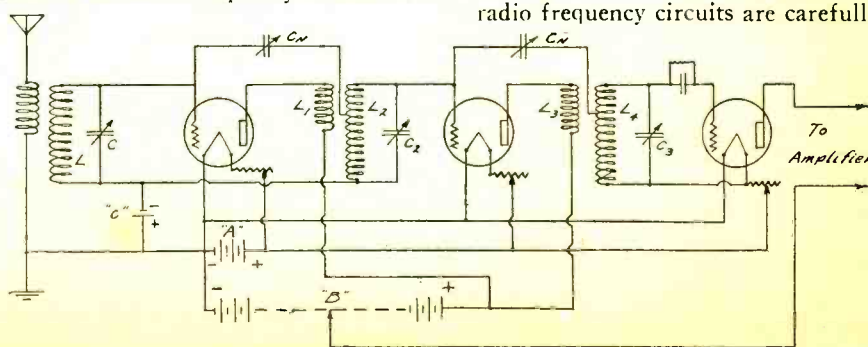

Fig. 2. Circuit Diagram of Neutrodyne Receiver

signed and the limitation of regeneration is carried only to the point where oscillations are not produced there is no reason why a tube detector with one or two stages of radio frequency amplification ahead of it should not deliver a much stronger audio frequency signal than could be obtained by the use only of a regenerative tube detector circuit connected directly to the aerial.

Theoretically, after the neutralizing condensers C_N are correctly adjusted for the prevention of oscillations for one adjustment of the tuning controls this adjustment should be correct for all adjustments of the tuned circuits providing the tubes in the set are not changed. In practice, however, this is not always the case and it may be found that when the neutralizing condensers are adjusted to the point where oscillations are prevented at a particular tuning adjustment the set will begin to produce oscillations if the tuning adjustment is changed. It would seem therefore that the experimenter thoroughly acquainted with the operation of his set might obtain better results if the setting of the neutralizing condensers could be easily varied. The operator could then control the regeneration in the radio frequency stages at will and operate the receiver at maximum selectivity and sensitivity at all wavelengths. Manufactured sets are usually permanently adjusted at the factory in such a manner that in general radio frequency oscillations will not be produced regardless of the wavelength to which the set is adjusted. This may mean that slightly better amplification is obtained at one wavelength than at others.

It will be seen by reference to Fig. 2 that a tuned radio frequency amplifier having two stages of radio frequency amplification has three tuned circuits

and three tuning controls. For the reception of distant stations all three of these circuits must be tuned to the wavelength to be received. Until the operator has made a chart showing the three settings which must be used to adjust the set for any particular station the adjustment of the three circuits to the same wavelength is rather difficult. After such a chart has been made, however, it is a simple matter to find any station by referring to the chart and adjusting the set accordingly.

The original calibration of a three-dial set is best accomplished on a night when static or induction disturbances are fairly strong. When the dials are so adjusted that the noises resulting from static or induction are loudest the three tuned circuits are adjusted to the same wavelength. By varying one of the dials a little at a time and then adjusting the other two until the noises again are at a maximum, the entire wave band covered by the receiver can be searched and all stations in operation giving a sufficiently loud signal to be heard can be logged for future reference.

It is common practice to use from 90 to 120 volts on the plates of both the audio and radio frequency stages of a set using tuned radio frequency such as is shown in Fig. 2. Unless a correct negative bias is used with amplifiers operating at such high plate voltages heavy plate currents will flow and grid circuit losses will result due to the flow of current to the grids when they are positive with respect to the filament. The flow of grid current may not be important in the radio frequency stages where the alternating currents and voltages are relatively small, but will cause distortion and loss of efficiency in the audio frequency stages. Distortion will also result due to the fact that the tube is not operated on the central portion of the characteristic

curve. The writer is moved to mention the fact as but few manufacturers and experimenters appear to recognize the importance of a correct negative bias when high plate voltages are used, and many sets do not provide for any negative voltage on the grids of the amplifier tubes. (A complete discussion of the theory of the use of a tube as an amplifier which discussed this point in detail was given in an article by the author appearing in RADIO for August, 1924).

Fig. 3 shows a very satisfactory comparatively simple three-tube receiving set using one stage of radio frequency amplification, a tube detector and one stage of audio frequency amplification. If loud speaker reproduction is desired additional stages of audio frequency amplification can be added. Certain features of this circuit are worthy of note. Only two tuning controls are used which makes the set somewhat easier to tune than the one shown in Fig. 2. A negative bias is used on the radio frequency amplifier tube for the reasons just brought out. The same C battery can be used for the audio and radio frequency amplifier tubes if desired.

Instead of building a radio frequency transformer using two closely coupled coils to provide a means of feeding back voltage to the grid which will limit regeneration, use is made of auto transformer action in a single coil. Exact physical dimensions of this coil L_2 will depend upon the wavelength band it is desired to cover. Approximately 60 turns on a 3 in. tube are suggested for use with the average condenser for radio-cast waves. Approximately one-sixth the total number of turns should be included between the base of the coil and the B battery tap and another sixth between the B battery tap and the tap which goes to the plate of the radio

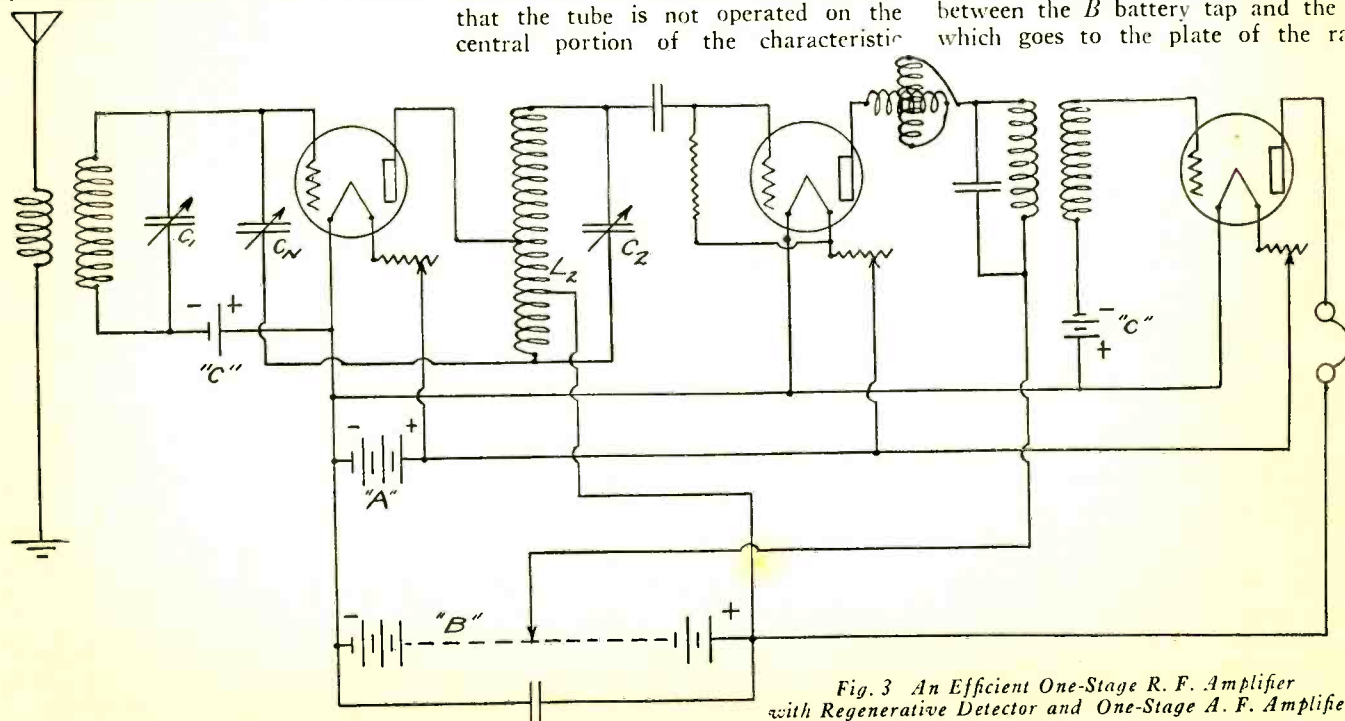

Fig. 3 An Efficient One-Stage R. F. Amplifier with Regenerative Detector and One-Stage A. F. Amplifier

frequency amplifier tube. The neutralizing or regeneration limiting condenser C_N is connected to the base of this coil. It is necessary to connect the grid leak directly to the positive side of the detector tube filament. If it were across the grid condenser as is common practice the full voltage of the B battery would be applied to the grid of the detector. It is also necessary to use a grid condenser capable of standing this B battery voltage without leakage.

Regeneration is provided in the detector circuit by the insertion of the variometer V . A tickler coil in the plate circuit of the detector tube coupled to L_2 might be used in place of the variometer for the same purpose. Regeneration in the radio frequency amplifier circuit can be controlled by varying the capacitance of the small condenser C_n . As has been explained, however, but little of this adjustment is necessary beyond that originally made to prevent the production of oscillations or completely eliminate regeneration.

A valuable feature of a set which provides for regeneration in the detector circuit is the fact that the regeneration can be carried to the point where oscillations are produced and the beat note which results when the circuit LC_2 is tuned to a frequency near that of an incoming signal may be used as a means of tuning for weak signals. As the oscil-

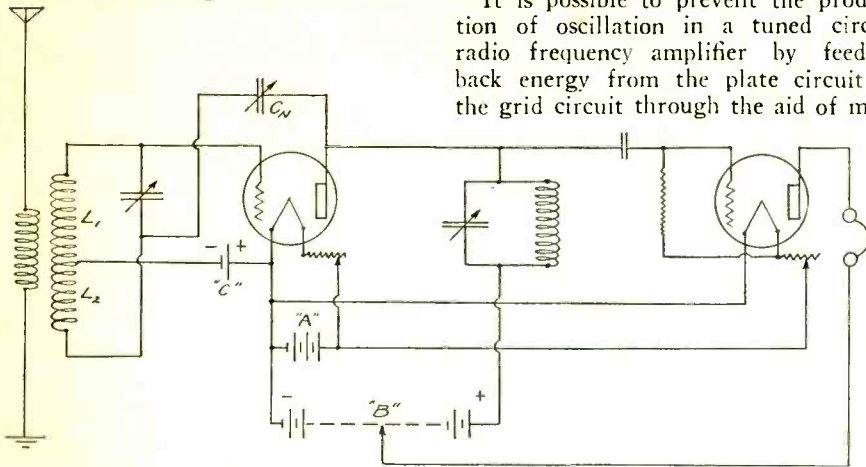

Fig. 4. Wheatstone Bridge Balanced R. F. Amplifier Circuit

lations produced in the set are not produced in a circuit coupled to the antenna, the receiver does not radiate and thereby cause objectionable disturbance to nearby listeners. The setting of the dial controlling C_2 at which its circuit is tuned to various stations can be logged on a chart and this chart used for future reference. The variometer method of regeneration in the detector circuit is recommended because in general the effect of the variation of regeneration by this method on the tuning of the detector circuit will not be great. A circuit similar to the one just described has been used with very satisfactory results in sets designed for the United States Signal Corps by the Radio Laboratories at Camp Alfred Vail.

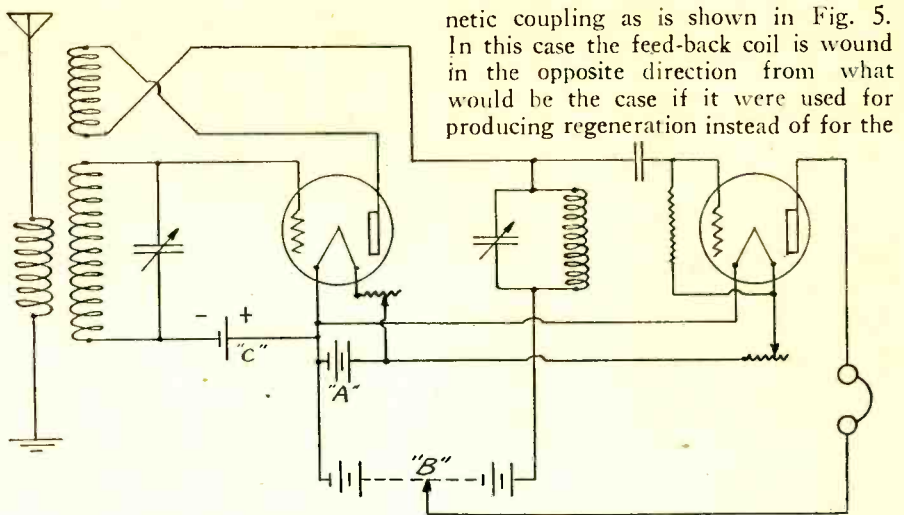

Fig. 5. Limitation of Regeneration with Reverse Feedback Coil.

Fig. 4 shows a somewhat different method of preventing the production of oscillations in radio frequency amplifier. Coupling between the aerial coil and L_1, L_2 is made very close and the aerial circuit instead of the tube circuit is tuned. This is sometimes known as the Rice circuit. Control of regeneration or neutralization, if the reader chooses to call it, is obtained by varying the condenser C_N . The writer has never had first-hand experience with a circuit of this type so cannot give information as to its merit.

It is possible to prevent the production of oscillation in a tuned circuit radio frequency amplifier by feeding back energy from the plate circuit to the grid circuit through the aid of mag-

netic coupling as is shown in Fig. 5. In this case the feed-back coil is wound in the opposite direction from what would be the case if it were used for the

purpose of offsetting the effect of regeneration already inherent in the system due to grid plate capacitance in the tube. If oscillations are produced due to this capacitance the coupling between the feed-back coil and the grid circuit coil is increased until the effect of the energy fed back to the grid circuit in this manner sufficiently offsets the regenerative effect produced by the energy fed back through the grid plate capacitance to enable stable operation of the system as an amplifier. The reverse feedback coil is sometimes called a stabilizer.

One objection to this type of circuit is the fact that a new adjustment of the reverse feedback coil is necessary for every change in wavelength of the set. For this reason it is not feasible to use more than one stage of radio frequency amplification. However, very excellent results can be obtained with circuits of this type as the beneficial effects of regeneration are taken advantage of in the radio frequency circuit. The tuning of the circuit coupled to the aerial will change to some extent with the adjustment of the feed-back coil but it should be possible to calibrate the tuned circuit CL_2 and in this manner easily locate stations after they have once been logged. A commercial set using the principles just suggested is now on the market.

Fig. 6 shows a somewhat different type of circuit in which the plate circuit of the radio frequency amplifier is not tuned but contains a continuously variable in-

Continued on Page 60

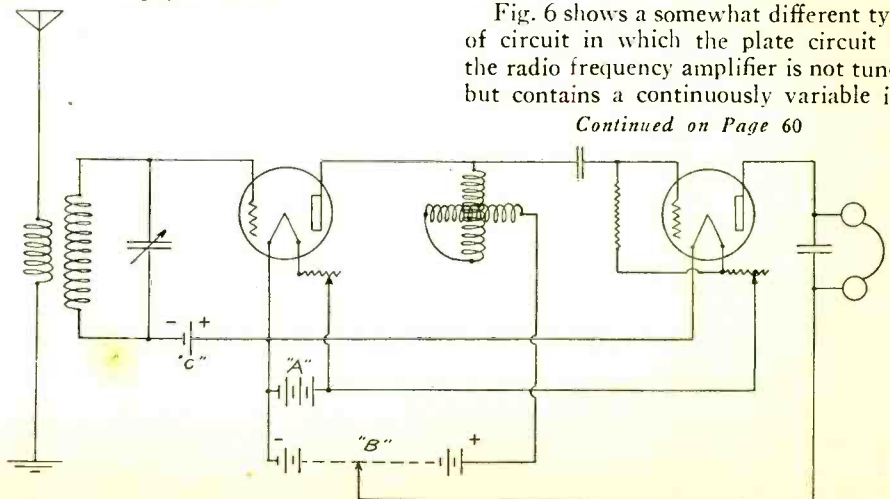

Fig. 6. Regenerative Variometer-Coupled R. F. Amplifier

An Inexpensive High-Speed Chemical Code Recorder

By Harry W. Minnermann

FEW radio experimenters are able to avoid that spell of code recording that usually comes in the second or third year. It is natural, of course, that true experimenters should eventually be seized with a desire to put the dots and dashes down on a tape just for the pure fun of doing it. To do this efficiently and rapidly usually requires more time, money and research work than the average fan can afford and precious few have succeeded in assembling practical apparatus for this purpose.

A simple chemical recorder can be assembled with tin cans and bits of junk at a maximum cost of \$1.50.

The action of the device is based upon potassium iodide (KI). This usually comes in small, white crystals that readily dissolve in water, forming a perfectly colorless solution. If a piece of paper is dipped in this solution and brought in contact with the leads from a single old dry cell, a sepia line due to the liberation of free iodine, will be left on the paper when the positive wire is

drawn across it. Of course, the negative wire must be held in contact with the paper at the same time. So sensitive is this chemical to the passage of an electric current that a few milliamperes are sufficient to leave a distinct record of the points passed by the wire.

The writer was probably fortunate in having the metal reels available in his junk pile. These measure about 4 in. across and are wide enough to carry the standard ticker tape used in brokerage offices. Of course, it would be an easy matter of cut out three brass discs from 32-in. stock and make up the reels. A thread spool cut down will serve for

the hub. The holes in the discs are totally unnecessary and may be dispensed with.

The standards carrying the metal reels are cut from 1/16th in. stock, for it is evident that they must be strong enough to carry a full reel without bending. This would throw the tape out of alignment and render the entire device inoperative. Examination of the drawing will show that only three of the reel standards are needed. The reel from which the tape is fed must be taken off for refilling occasionally. A single standard with a brass shaft fixed

Continued on Page 69

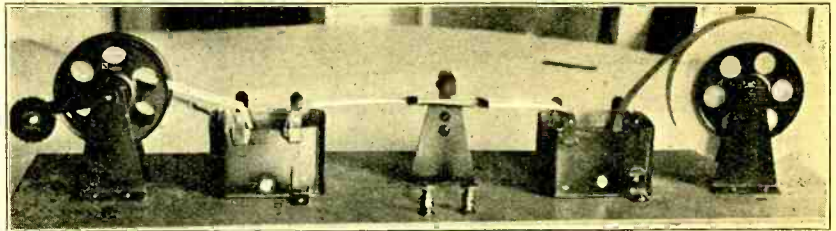

The Completed Code Recorder

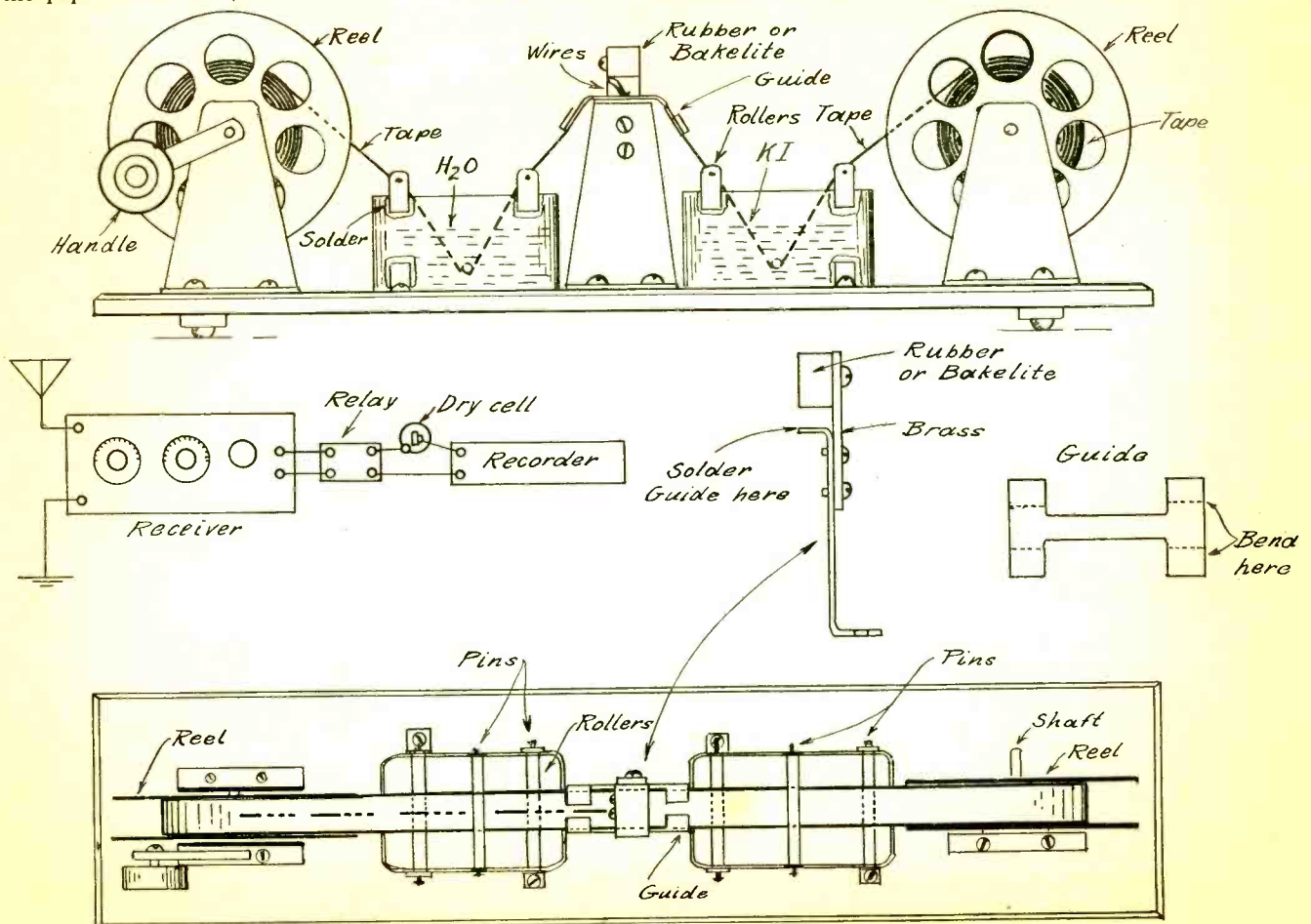

Constructional Details of Code Recorder

A Second Step of Radio Frequency for the Two Tube Reflex

A Simple Means for Satisfying the Urge for DX by Improving Its Selectivity and Sensitivity

By E. C. Nichols

THE two-tube reflex is all that can be wished for in reception of local stations, but is lacking in selectivity for distance and requires a silent night for any sort of DX demonstration. The addition of a third tube will solve this difficulty.

A little experimenting with the various circuits will reveal the following facts:

First: A third stage of audio will give greater volume, less quality and no increase in selectivity or sensitivity.

Second: The addition of a tube detector will increase the sensitivity and volume at the sacrifice of quality and stability with very little increase in selectivity.

Third: The addition of a second stage of radio frequency will give the desired combination of selectivity, sensitivity, quality and volume for both local and long distance stations. The addition of this third control does not add any great difficulty in tuning as the third dial is not critical. The tendency toward self oscillation is removed by applying the method of counterbalancing the internal capacity of the tube, invented by C. W. Rice of the Western Electric Company.

Having found the addition of a second stage of radio frequency the most desirable, the next consideration will be the selection of parts. A receiver located near radiocast stations should use the lower ratio audio transformers to insure good quality, because of the stronger initial signal received. These

ratios should be 3 to 1 in both stages. A receiver located some distance from any source could use two 5 to 1 or 6 to 1 transformers. A higher ratio is not advisable. The logic of this will be apparent when we consider the relationship of strength of signal received to volume delivered by receiver.

The condensers can be the usual .0005 mfd. (23 plate) or the .000375 mfd. (17 plate). The coils can be made or purchased and modified as required. The counterbalancing condenser should not exceed .00005 mfd. with a very low minimum. A vernier condenser is not

Primary 15 turns 12 ft.

#24 D5C or 5CC

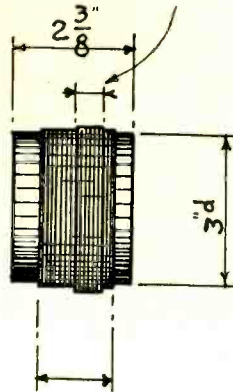

Secondary 55 turns 44 ft

24D5C or 5CC

Standard Coil Dimensions

desirable. The selection of the remaining parts requires no special note.

Each of the three coils should be wound on 3-in. diameter tubing with 15 turns on the primary and 55 turns on the secondary of No. 24 silk or cotton covered wire. Two of the coils are tapped at the center of the secondary winding. The primary may be wound directly over the secondary with thin silk or paper between the two windings. The coils are placed in the set at right angles as shown in diagram.

As a suggestion to those experimentally inclined, the toroidal coil should pay them for their efforts since, in this coil, all inductive effect between the coils is removed, permitting greater amplification. A diagram is shown giving general dimensions for manufacture. It is interesting to note that this coil has the added advantage of low internal capacity, comparing favorably with the low capacity coils on the market.

The construction of the set can be carried out by the step method. All wiring should be temporary, silk or cotton covered wire, excepting the filament circuit, which may be permanent. The final wiring can be done after the set has been tested and arranged.

The reflexed tube will be the first to wire and test, for which test the antenna and ground are connected to the primary

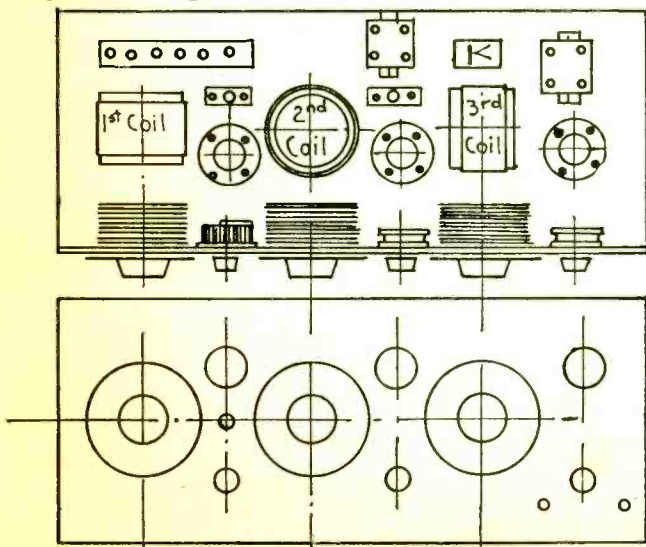

Panel 7 x 21"

Front and Back Panel Mounting

Toroidal Coil Data:

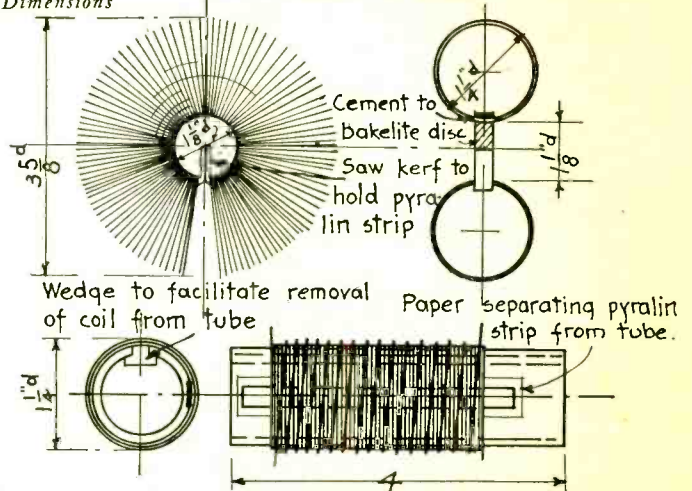

Secondary 205 turns 67ft #28D5C or 5CC
Primary 20 ft. #28 D5C or 5CC to extend over entire length of secondary.

Primary + secondary are cemented to pyralin strip with collodion.

Toroidal Coil Dimensions

of coil No. 2 and the phones in place of the primary of the second audio transformer. In testing this step, if there is a tendency toward self oscillation, reverse the primary connection on the last coil. There have been numerous complaints that the two-tube reflex has a tendency to oscillate. The above adjustment is a sure cure. The counterbalancing condenser may be omitted, but in this case of adding the third tube, its presence insures no self oscillation.

In the next step add the second stage of audio in the usual way. Try a .005 mfd. fixed condenser on the primary of the audio transformer for increased volume. A .00025 condenser on the secondary is not necessary except in the necessity of improving the quality.

The final step is the adding of the first step of radio frequency. The most important adjustment here is that of the counterbalancing condenser. This adjustment, however, is simplicity itself, and not as critical as the same adjustment in the neutrodyne circuits. Here the capacity of the counterbalancing condenser is increased until all tendency toward self oscillation is removed. The counterbalancing condenser should be carefully tested for a possible short circuit, as a short-circuited *B* battery would result. It should be stated that the counterbalancing condenser is also a help in selectivity. A test with it and without it will demonstrate this. The *C* battery connected with the potentiometer as shown in the diagram, insures the proper grid bias on the first tube, better quality on local reception, and helps in getting distant stations.

The antenna arrangement of fixed condensers and point switch can be used or not as desired. This arrangement is a great help in selectivity, and the long antenna in combination with it has all

the advantage over a short antenna. A variable 23-plate condenser can be used in place of this arrangement. The fixed condensers on the *C* battery and potentiometer, and on the *B* battery, are used as a pass-by and are for greater efficiency.

In Pasadena, probably one of the poorest locations in California for long-distance reception, this receiver has brought in stations in Chicago, Calgary, Canada; Chihuahua, Mexico, etc., with four 500-watt local stations on the air. The receiver will tune within ten meters of local stations in this long-distance work.

The list of parts is as follows:

- | | |
|-------------------------------------|---|
| 1 Front panel 7 by 21 in. | 6 Binding posts |
| 1 Baseboard 9 by 21 1/4 in. | 1 Pc. bakelite, 1 by 6 by 1/4 in. |
| 1 Filament snap switch. | 3 Pcs. 3 in. diam. tubing 2 1/2 in. long |
| 1 400 ohm potentiometer. | 1 Crystal detector |
| 3 Sockets. | 2 Counterbalancing condensers |
| 2 Rheostats. | 1 4 1/2 volt <i>C</i> battery |
| 2 Audio Transformers. | 1 Point switch and 4 points. |
| 3 17 or 23 plate condensers. | Fixed condensers, dials and miscellaneous small parts as described. |
| 2 Single Jacks. | |
| 1/4 lb. No. 24 D. S. C. or S. C. C. | |

Powerful radio transmitting equipment is being installed in a new laboratory being built by the General Electric Co. six miles south of Schenectady. This will be devoted to a study of means for improving transmission quality and reliability and to tests on static and fading. The transmitters will have a maximum power of 100 kw. with plate supply as high as 30,000 volts d. c. The antenna structures include three towers 300 ft. high arranged in the form of a triangle. From these steel masts almost any type of antenna may be strung capable of operation between 600 and 3,000 meters. A fourth steel tower, 150 ft. high, may be connected to any of the trio of masts for work on wavelengths from 200 to 600 meters. In addition to the steel towers there are numerous wooden masts for antenna systems for experimentation on wavelengths from 15 to 200 meters.

In using small tubes, such as the 199 types, use the best voltmeter you can get. Some cheap voltmeters draw as much as 0.05 amps., on 4 or 5 volt full scale reading, and this is as much, nearly as one of the tubes themselves draw.

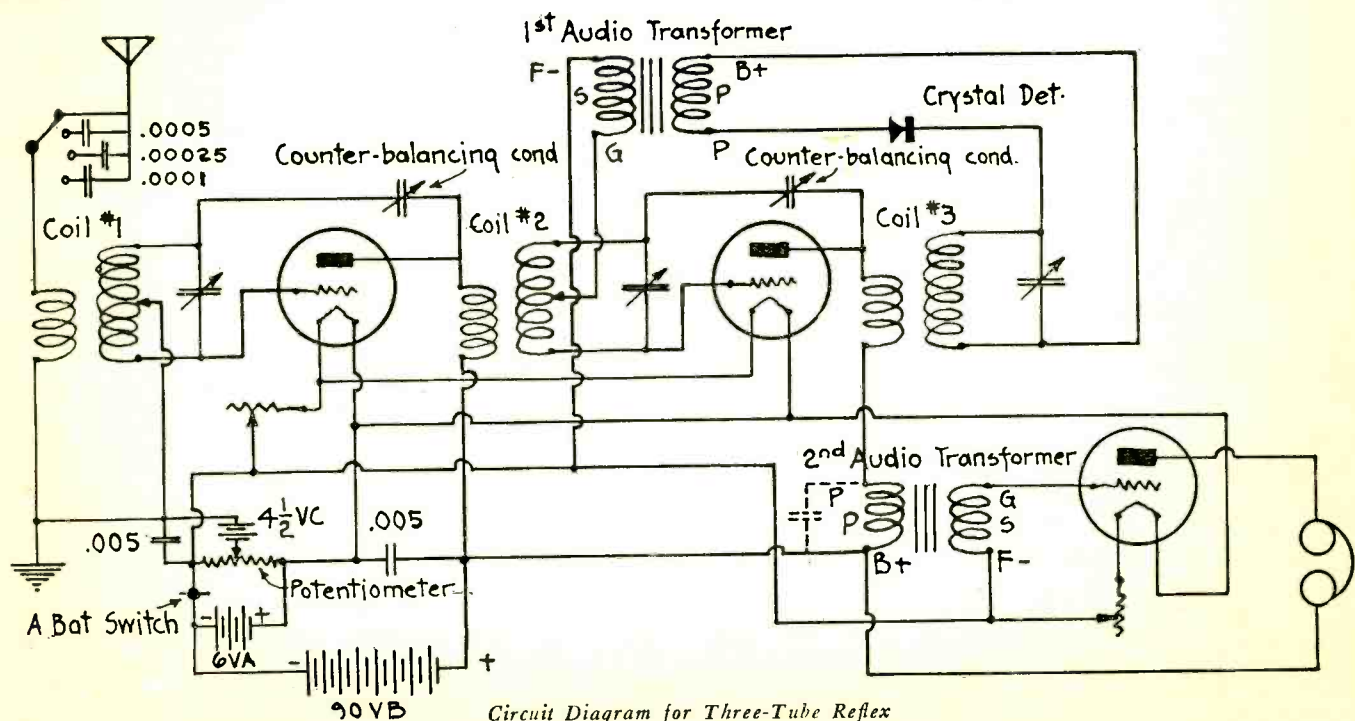
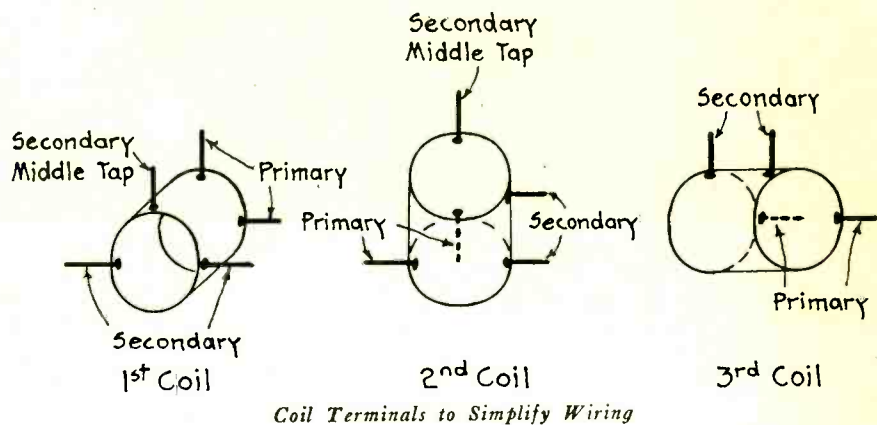

Circuit Diagram for Three-Tube Reflex



"Jimmy Assumed a Dramatic Pose."

A Kiss in the Dark

By Oliver B. Scott

"JAMES, if you don't stop making a nuisance of yourself and leave us alone, I'm going to tell Dad about that awful gang of boys you've been running around with, when you were supposed to be in bed."

"Aw, Sis, —"

"Never mind, now—you run along and leave Clarence and me alone."

Jimmy Watson shuffled out of the back door, grumbling to himself about having a sister who always had a "sweetie" come to see her whenever he wanted to experiment with the family receiver.

"Just the night when the local stuff is off," he sputtered, "and I can try for Chicago, here she goes an' makes me get out so's she can get mushy with that skinny high school sheik. Doggonit, I wish I could get sump'n on her so's she wouldn't boss me 'round all the time."

The stars twinkled merrily on little Jimmy as he trudged along the lawn to the sidewalk. A cool evening breeze stirred the leaves about him on the grass.

"The best night in the world for getting DX," he mused. "Guess I'll go over to Willie's and see if he's going to do anything tonight. Gee, Willie's a lucky guy. His folks let him monkey with their set any time he wants to."

Jimmie swung off the street and across a vacant lot in the direction of Willie Smith's. In a few minutes he was in the Smith's parlor, watching Willie majestically spin the dials of the big neutrodyne.

"Just put a C battery in the set this afternoon," announced Willie. "She's got an awful wallop now, Jimmie, an' it don't pull the B batt. down a bit more, either."

Mr. and Mrs. Smith looked at each other with a nod of parental satisfaction.

"That'd be sump'n good to tell the boys at the next meeting of the Radio Club," said Jimmy.

"Oh, I've got sump'n lots better'n that," replied Willie. "C'mon in my room and I'll tell you about it."

Closing the door behind them, the

boys threw themselves on the bed, sprawled out on their stomachs and kicked their feet in the air.

"I thought I'd tell the fellers about how to talk into a set and make the sound come out of the loudspeaker," announced Willie.

"How's that," queried Jimmy.

"Well, y' hook your receiver, or a telephone transmitter, or a microphone to the primary of your first audio frequency transformer, and when you talk into it y' can hear it through the horn."

"Gee, that'd be great."

"Yea, y' could make 'em think y' had Chicago, just by talkin' into it."

"Um hum." Jimmy was thinking hard.

"I'm goin' to play it on the folks some night pretty soon, so don't tell nobody," cautioned Willie.

"Naw, I won't," answered Jimmy. "Say, I got an idea how we can raise some jack for the Radio Club. We'll get a bunch together an'—"

Before Jimmy was half through ex-

Continued on Page 62

Experimenting With a Loop

An Account of Numerous Experiments and Adaptations Tending
To Improve Reception

By Harry A. Nickerson

MANY radio fans get "loop fever" and seek to add a loop to a set intended for use only with an outdoor antenna. The results are usually discouraging. Principally this is because the loop is responsive mainly to but one of the two components of the radiocast wave,—namely, the "magnetic." The loop is but slightly affected by the electrostatic force which strongly affects the outdoor antenna of the usual type.

Trial of the loop as an antenna, even with sets not adapted to it, may be made by attaching either one or both ends of the loop wire to the antenna post of the set. The results will not equal those of a short length of indoor antenna, but if the set is fairly sensitive, local stations and semi-distant ones may be heard with fair volume.

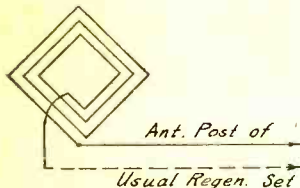

Fig. 1. Attaching Loop as Antenna to Ordinary Set

It is usually preferable to use the loop both as "tuning coil" and "pick-up" coil, omitting the usual "tuning coil" in the set. Since the pick-up of the loop increases with its size, providing the proper tuning range is secured, it pays to use the turns of the loop to provide all the tuning inductance necessary.

It seems to be standard practice to "tune" a loop with a shunted .0005 mfd. variable condenser. Other capacities may be used. It is helpful to remember in such cases that *where the capacity of the condenser is halved*, the maximum wave length under the new conditions is about 71 per cent of the former maximum. If both condensers are of the same make and style, of course the *minimum* wave length is decreased when the number of plates is lessened.

Whatever condenser value is used, convenience demands that a wave length of at least 220 to 550 metres be covered. The following data from a pamphlet published by Acme Apparatus Co. of Cambridge, Mass., are valuable. Note that spacing of turns increases with increased size of loop.

Dimensions for Spirally-Wound Square Loop, Tuning 225-550 Meters with .0005 Mfd. Shunted Condenser

(Inductance approx. .16 m. h. with No. 18 wire).

No. of Turns	Spacing Between Turns	Diagonal of Square Made by Outside Turn
11	1 25/64 in.	66 in.
12	1 in.	52 in.
13	3/4 in.	43 in.
14	9/16 in.	35 in.
15	29/64 in.	30 in.
16	3/8 in.	26 13/16 in.
17	9/32 in.	21 1/2 in.

It will be apparent that the "pick-up" of the 3-foot "box-type" or loop is greater than the "spiral" wound 3-foot type. In the spiral type, the inner turns are very considerably less in diameter than the outer ones, while in the box type, all the turns have the same diameter. But owing to the greater ease of construction of the spiral type and the fact that it occupies less space, this type seems to be in more general use. By making its frame somewhat more than 3 feet its "pick-up" may be brought up to that of the box type.

The first thing noted by loop users will probably be that the loop is not as directional as its advocates describe it. It will give a very strong signal on a certain station not only when the plane or edge of the loop points toward that station but also when the plane is turned considerably away from that station. But the minimum signal strength is sharply defined when the plane of the loop is at right angles to the station heard. Fortunate is he who lives at such a position with respect to strong local stations that he may point the plane of the loop at right angles to the locals in order to hear the distant stations.

The use of several stages of radio frequency amplification or of the neighbor-annoying super-regenerative set seems necessary for satisfactory loop reception. Occasions, however, are frequent, where dwellers in buildings with walls sheathed in metal have been forced to use an outdoor antenna owing to the fact that the magnetic component of the wave is absorbed by the metal. Using the loop in front of a window then offers about the only way out of a difficulty.

If one has a good multistage radio frequency set, using a loop as a tuning inductance, a 50-turn honey-comb coil may be shunted across the usual loop terminals. If the loop is disconnected and is placed fairly close to the honeycomb and with its plane parallel to that of the coil,

there will be sufficient "loose coupling" so that the set will function surprisingly well. It is mystifying to the uninitiated to see the set operate with only a honey-comb for an antenna.

The loop may be used as a secondary with an untuned primary added in several ways: e. g.:

1. By winding a few turns on the usual loop frame but inside the outer loop turns, connecting one end of the new winding to antenna and the other end to ground.

2. By winding a few turns in the slots of the loop frame, just over the usual loop turns and connecting one end to antenna and other to ground.

3. By using a small loop as the secondary and a large one for the primary, the small loop being connected to antenna and ground.

4. By connecting the outdoor antenna to the middle of the usual loop winding and connecting ground to one end of loop winding.

5. By connecting one or two turns of the loop next to one end, to the antenna, and loop end turn nearest, to the ground.

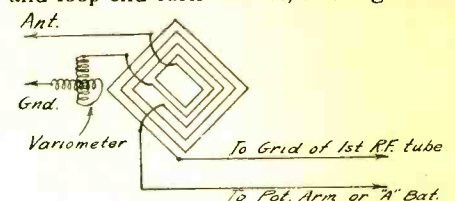

Fig. 2. Variometer Tuning of "Untuned Primary" on Loop

The "untuned" primary may be tuned to make better selectivity and volume at the expense of an additional control by the addition of a variometer or a condenser in the untuned primary circuit. The variometer should be in series and the condenser tried both ways, in series and in shunt. Fig. 2 and 3.

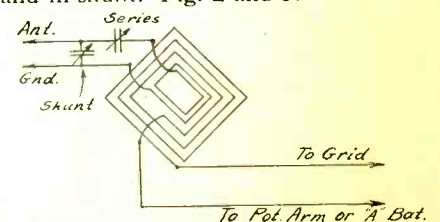

Fig. 3. Condenser Tuning of "Untuned Primary" on Loop

Grounding one terminal of the loop itself (usually that terminal which does not eventually connect direct to the "grid" of the tube socket) generally re-

Continued on Page 72

An Improved Loop Antenna

Intended for Use With Rounds No. 16 Circuit
But Adaptable to Other Circuits

By A. H. Vance

THE writer has been a persistent user of Rounds 16 circuit for the past two years, and has been able to obtain some remarkable results. This circuit, however, as shown in Fig. 1, has a very serious fault of radiating, which would make it taboo in any city at the present time. The tube acts as a radio frequency amplifier and oscillator and detection is accomplished by means of a crystal. Two or three stages of audio frequency amplification may be used to secure the desired volume.

writer, following directions given by Mr. Paul W. Pettet, an instructor of practical electricity in Chicago. In theory this loop makes use of the known facts in regard to wave forms and also makes use of some new theories or radio communication as formulated by Mr. Pettet.

This loop can be made in a variety of different shapes. Only two of these will be described here, one of them being remarkably efficient, the other not quite so efficient but possessing other advantages. They are both of the non-directional type.

One side of this loop is shielded in order to make use of the full wave and not allow it to be neutralized in part by an opposing current generated in the

length. A sharp wave would give a greater phase difference to act on the opposing sides of the loop. A broad wave will give a small phase difference. Fig. 2 (b) will help to make this point clear.

If it were practicable to make the loop of a size to correspond to the wave length, that is 180 meters on each side when it is desired to receive a 360-meter wave, then the maximum energy could be absorbed by the loop. As a loop of anywhere near this size is impracticable, the slight phase difference must be used.

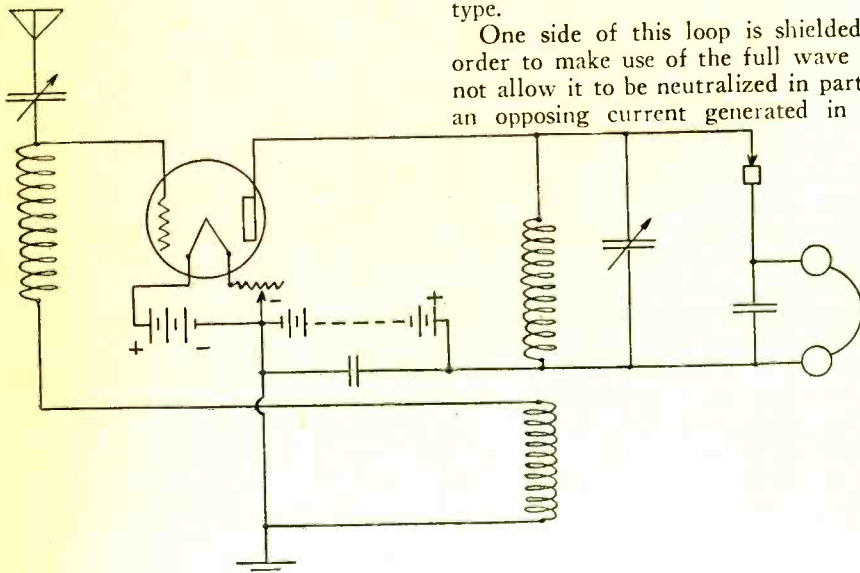
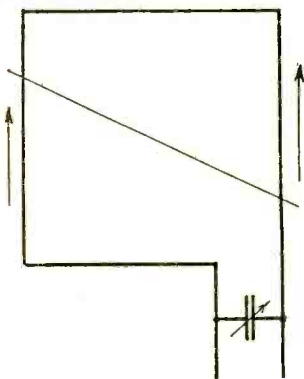

Fig. 1. Rounds No. 16 Circuit Diagram

While this circuit is very selective, very consistent, and good for long distance reception when properly tuned, all the stations in the United States can be received at the same time when it is not tuned properly. A little experience in operating the set will work wonders in the results obtained.

The set is a persistent oscillator and would not be tolerated by the neighbors if it was used on an outside aerial. It must oscillate in order to work properly. The oscillations must be weak and in tune with the incoming signal. If they are too strong or are out of tune the voice becomes mushy. The selectivity is also destroyed.

The fact that the Round circuit uses only one stage of radio frequency has heretofore made it practically impossible to operate it on the present type of loop antenna. Now that a new and very efficient type of loop is available this circuit can now be used in crowded localities without causing trouble from radiation. This new loop was designed by the



(a)

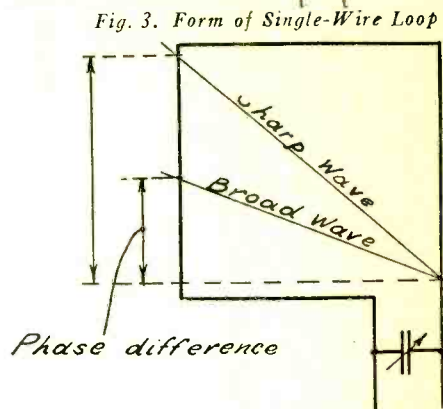

Fig. 2. Theory of Loop (b)

other side of the loop. An examination of Fig. 2 will make this clear. At (a) is shown the wave effect on the standard type of loop. It will be seen that the current induced in one side of the loop is almost immediately opposed by a current induced in an opposing direction in the other side. The amount of energy received in a loop depends on the decrement of the wave and also on the wave

In the loop shown in Fig. 3 this opposing current is wiped out by means of a shield which is connected to the ground and in this way carries any opposing current to the ground. The wires on one side of the loop are passed through a metal tube which constitutes the shield. This tube may be of any good conducting material such as brass, copper, or

Continued on Page 78

A Low-Loss, Low-Wave Helix

By G. F. Lampkin, 8ALK

THE new short-wave regulations opened many fields for the amateurs; both in the design and construction of new apparatus and in the results possible with it. There is no fundamental difference between the short-wave apparatus and that used on the longer waves. It is mainly a question of size, and of keeping losses low that are not of great importance on the higher waves. No originality can be claimed in the design of the helix shown below—the object is to save the builder the time in figuring out and drawing up the details.

A helix for short waves should be small in diameter, to allow an easy and accurate adjustment of the clips. It should have an absolute minimum of supporting dielectric in its field, consistent with mechanical strength. As inductive coupling is required under the regulations, provision must be made for an antenna coil, with variable coupling to the primary.

The helix is wound of 19 ft. of No. 5 bare, soft-drawn, copper. It is wrapped by hand on a $3\frac{1}{2}$ in. form, putting on the turns side by side and as smooth as possible. When finished and slipped off, it will spring out to a diam-

eter of about $3\frac{3}{8}$ in. The coil should be cut at the 12th turn to leave a primary of 12 turns, and a secondary of 6 turns. The ends of each coil should be grasped and pulled out until the spacing between the turns is approximately $\frac{1}{4}$ in.

The supporting material is hard rubber. The details of the separators and bases are shown. When the separators are cut and drilled, they are threaded on to the coil turns. The ends of the coils should be cut so that they overlap an inch; then the separator with the extra hole can secure both ends of the coil. The slots on the supports for the coils are slipped over the separators at the proper points, and the two pieces glued together.

The rod on which the antenna coil moves is of glass, $\frac{3}{8}$ in. in diameter. Gauge glass, or even a glass towel bar with the ends cut off, can be made to do; of course, the size of the support holes must be changed to fit. Wood is used for the rod support, for a better mechanical job can be done with it than with hard rubber.

The coils have a minimum of dielectric in their fields, but are still amply rigid.

The size, $3\frac{3}{4}$ in., is easily small enough, compared with the usual 6 to 8 in. diameter. A high-grade, low-loss, receiving condenser, with evenly spaced plates, can be used as a primary condenser. With a .0005 condenser, all the bands from 20 to 180 meters can be covered.

Don't blame your loudspeaker entirely when you get blaring on loud signals. Remember that this may be due to the signal being so strong that it causes a sort of temporary paralysis of the audio frequency tube, or tubes, by putting so large a charge on the grids that the plate current is stopped entirely for a moment. This is called "overloading."

Poor mica in condensers should be avoided, as it may contain mineral salts that entirely destroy its insulating value.

Binding posts on a set should preferably be mounted so that the terminals of high potential difference are well away from each other, as otherwise moisture and dust may collect and form a partial short circuit, which will reduce the signal strength.

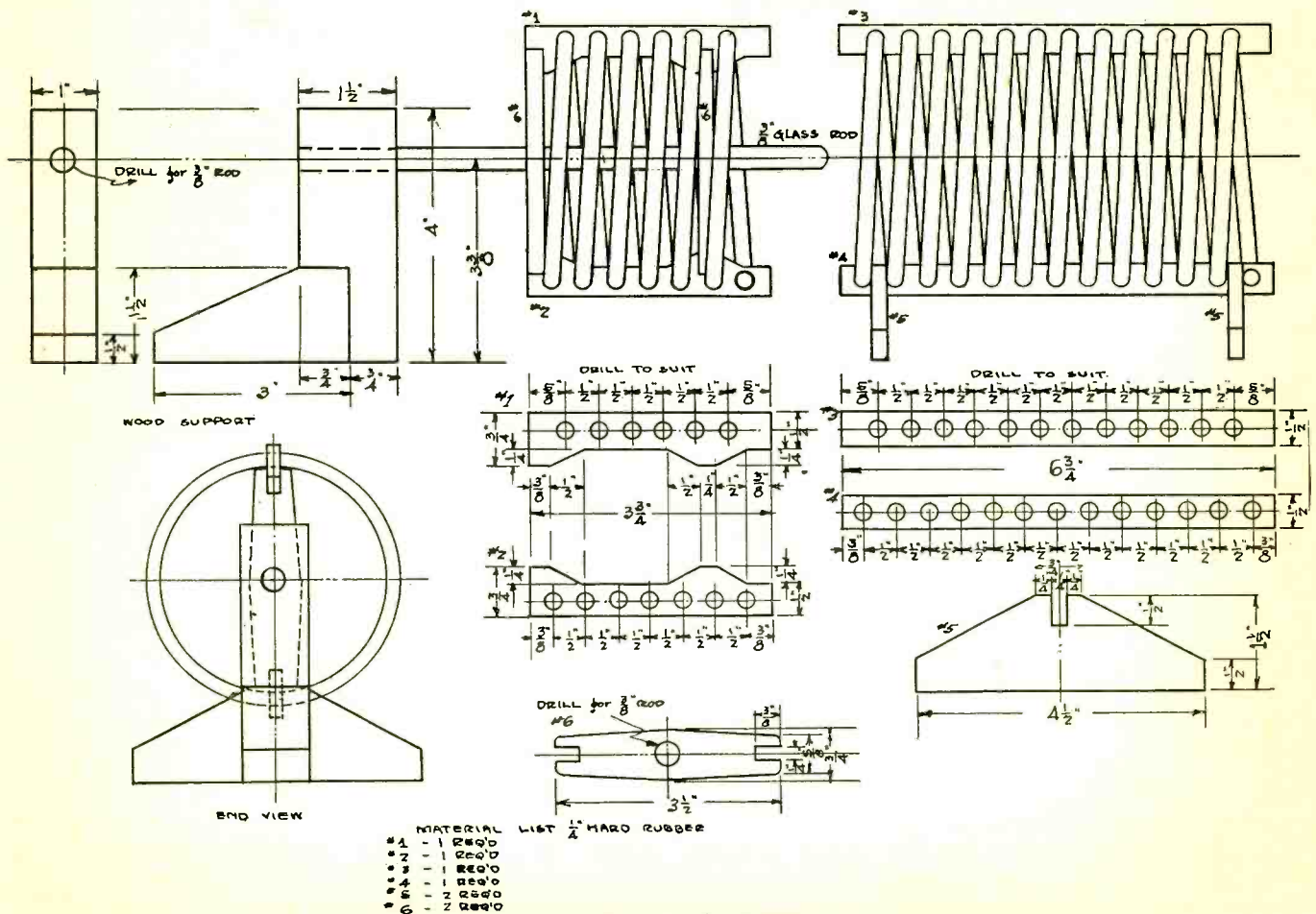

Constructional Details of Helix

Automatic Radio Telegraphic Relaying

The Theory and Practice of a Simple and Effective Means for Land Use

By Jack Bront

ATTEMPTS at automatic retransmission have long centered about the manipulation of mechanical relays in telegraphic radio signalling or else diverted to expensive and complicated cascade arrangements of apparatus. The commercial relay, for dependable operation, may usually require from 6 to as high as 20 milliamperes for general work. In addition, automatic retransmissions usually require two carefully calculated waves, one for reception and one for retransmission.

In the system described here, the automatic relaying apparatus functions on exactly the same wave as that of the original and distant transmitter. It has been used practically and represents an interesting departure from mechanical relays, and land retransmission.

When a regenerative receiver is adjusted to a point just on the verge of oscillation, there is an enormous increase in received signal audibility—since the feedback effect tends to reduce the circuit resistance to zero and boost the incoming feeble impulses. However, when adjusted to a point very near where oscillations begin, the system is in very unstable condition. If a slightly higher signal energy is applied, the circuit breaks into violent oscillation, and if constants are of certain relative values, the oscillations will persist in all likelihood even though the regeneration feedback is adjusted "back" of that point where oscillations first occurred.

Yet, if the receiver is so adjusted to the point where oscillations are ready to occur, and electrical (or mechanical) means are employed to rapidly connect and disrupt the local energy supply, and these variations be accomplished at a super audible frequency,—the incoming signal, with its local component varied in the regenerative process at a super-audible rate, will be greatly amplified due to the regenerative effect encountered at the near oscillating point,—though at the same time actual oscillation is prevented by the local interruptor. Since the variation rate of the interruptor is correspondent with inaudible frequencies, little or no audible variation tones will be recorded in the phones. A similar process is encountered in the super-regenerative receiver.

A tube transmitter, as in Fig. 1, may be compared with a regenerative receiver of like form but with greatly enlarged components and power. The same appar-

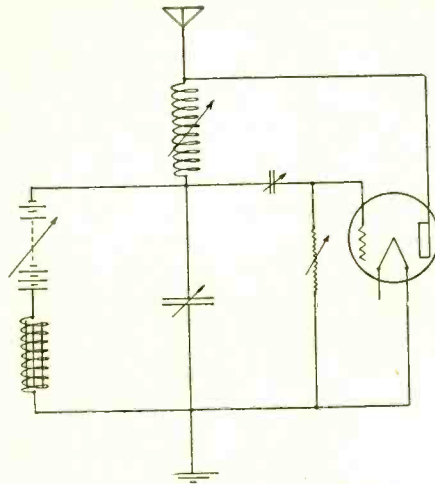

Fig. 1. Circuit Diagram for Tube Transmitter

atus may be employed as a receiver if recording devices are inserted in the plate circuit.

Regard this transmitter as being adjusted to an unstable and sensitive point near the adjustment where oscillations are imminent. A very slight addition of energy to the aerial of the transmitter will unbalance the critical stage and os-

cillations of violent form will take place,—which building up, will cause the circuit to transmit—its originally intended function. If some means are not employed to stop the oscillations and restore the circuit to the critical stage, the high frequency output will persist.

It is obvious that it would be extremely difficult and impractical to manually or mechanically readjust the circuit to the critical point,—and this continuously at high speed. However, regard an alternating electromotive force as being applied to the plate circuit instead of the usual D. C. If the circuit is adjusted to the critical stage, it is seen that oscillations will tend to become imminent only when the positive half of the alternator cycle charges the plate, and following, when the plate is negative, under the alternator influence, the circuit will be dead. The whole, therefore, is alternately active and inactive, the plate potential deciding which and acting as a governor of the tube operation.

Consider the tube during a period when the plate is positive, as adjusted to the critical point where oscillations are imminent but yet unformed. If a signal

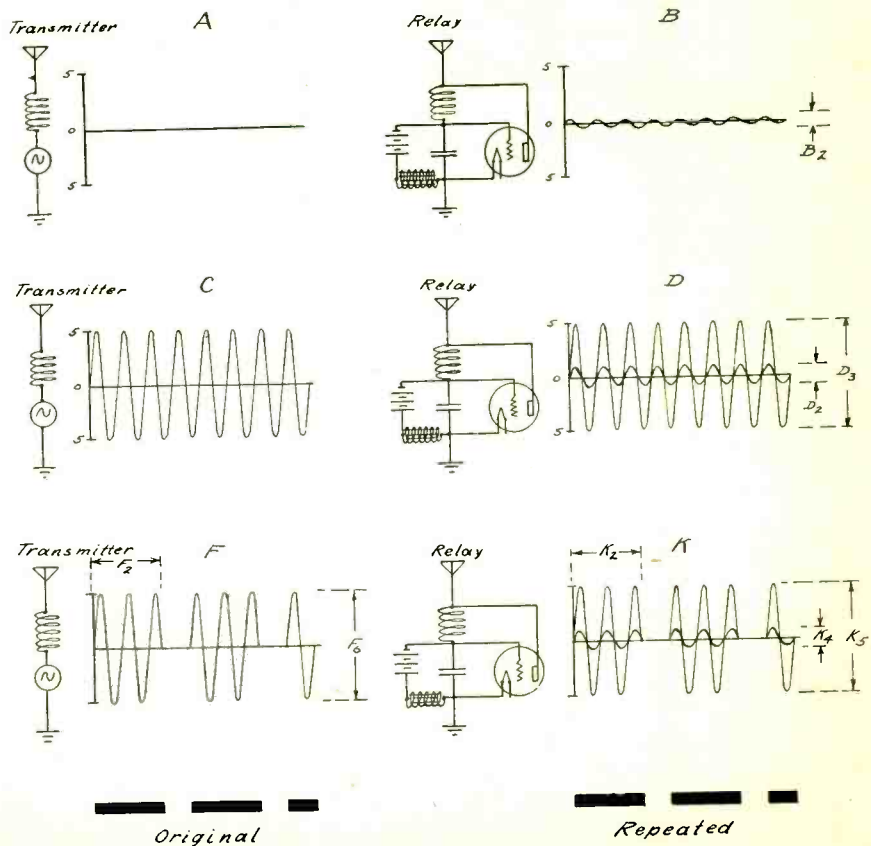

Fig. 2. Illustration of Relay Action

energy from a distant station be absorbed by the local antenna, although infinitely small in amplitude, nevertheless it will be sufficient to apply a grid potential of amplitude necessary to upset the critical adjustment and start the flow of oscillations. These latter persist only as long as the plate is positive, but when the plate potential is reversed and made negative, the oscillations will stop, even though the incoming signal persists continuously.

When the plate is restored to a positive potential the critical adjustment is also restored, and the persistent incoming signal will again provoke oscillations, which latter continue as before while the plate is positive, but cease when the negative half cycle appears.

Regard the incoming signal as a "dot" of the telegraphic code, and the alternator frequency as 100 cycles per second. If the "dot" be 1/10 second in duration, 10 cycles of the alternator will be applied to the plate during that time—and since a single cycle incorporates one positive and one negative potential (at the plate), and since the tube can oscillate only when the plate is positive, wave trains will be formed and radiated ten times in 1/10 second.

In the same process the tube will be "dead" ten times in 1/10 second, when no radiation or local oscillations will occur. If the transmitted wave is 50 meters that will correspond to a frequency of 6,000,000 cycles, which emission, however, is not maintained continuously, as the plate supply, therefore tube operation, is interrupted at a rate of 100 times (cycles) per second. Therefore, emitted signals at the 50-meter wave will bear a 100-cycle note at a distant receiver, be-

cause the incoming wave trains will appear in groups of 30,000 at a rate of 100 times per second. The duration of each group of 30,000 is only 1/200 of a second, since emissions occur only during the positive plate supply period which is manifest during each half alternation,—which full alternation occurs each 1/100 second.

Better understanding of the operation of the device may be probably gained by reference to Fig. 2. *A* represents the distant transmitter, the signals of which are to be repeated or relayed. Since the relay or repeater station *B* is actuated by received signals emanating from *A*, the wave lengths of both are identical.

Without radiation at *A*, the repeater station at *B*, adjusted to point of imminent oscillation, will not radiate, and infinitely small or no oscillations will occur locally. If such occur their amplitude may be represented as at *B2*.

Consider the distant transmitter in full operation (as at *C*),—then the repeater station (as at *D*) will be affected and will absorb a received signal of amplitude *D2*. This energy is sufficient to upset the critical adjustment of *D* and the latter will break into violent oscillation transmitting with an amplitude of *D3*.

However, if the transmission at the distant station (as at *F*) is in conformance with telegraphic signals, the repeater station (see *K*) will follow the transmission of *F* in exact replica,—oscillations being governed by the critical adjustment and the restoring action of the a. c. plate supply. However, the signal note of *K* will depend upon the frequency of the alternator supplying the plate—if the latter is 60 cycles, the emissions

will bear a 60-cycle note, if 100 cycles, the latter will correspond to 100 cycles in tonality.

Fig. 3 graphically illustrates the tube action. Beginning at *A*, the alternator frequency is represented. At *B* the uni-directional (rectified) plate current traversing the tube is shown (with the negative halves of the cycle discarded and unused.) *C* represents the alternate positive and negative potentials at the plate. *D* represents the radiation groups of 30,000 cycles each (at 50 meters) occurring 100 times a second, and enduring for 1/200 of a second.

It is well to consider the incoming signals charted between *D* and *I* as without the incoming signals, the oscillations of *D* are not formed. *I* represents the key manipulation and output of the distant transmitter. *2* represents the received energy which tends to oscillate in the repeater station grid circuit, in conformance with the distant emissions.

These grid oscillations act as a trigger for the whole process represented as originating at *A*, at the alternating plate supply and culminating at *D* in re-transmission of energy analogous to the code of the distant Key *I*.

Obviously the entire system necessarily is indicated for fixed stations and not for marine stations where difficulties would be great in maintaining the critical adjustment of the repeater apparatus,—although in fine weather at sea, considerable success might be accomplished.

Without doubt, the system is not limited to radio aerial transmission,—nor limited to a certain wave. Modulation of other and different transmitting frequencies could be accomplished, and signals even fed into wire land lines using the "carrier" system, such as long distance lines.

The outstanding virtue of the scheme lies in the fact that relay re-transmission can be accomplished automatically, without the touch of a key, or operation of mechanical relays at the intermediate station,—and that the relayed emissions are in exact conformity to the original emissions at the distant transmitter.

Necessarily interference and atmospheric present a problem, yet such a two-way system, with operators at both ends, would function the same as if there were two stations working direct, instead of through the intermediate repeater station.

Some interesting new developments are happily expected and about due.

Don't think because you have moved your storage battery down into the basement that it is low, when you run No. 18 wire up to the set using 4 or 5 tubes, as the voltage drop on a long line of such wire will often be as much as a volt, with consequent poorer results in the receiver.

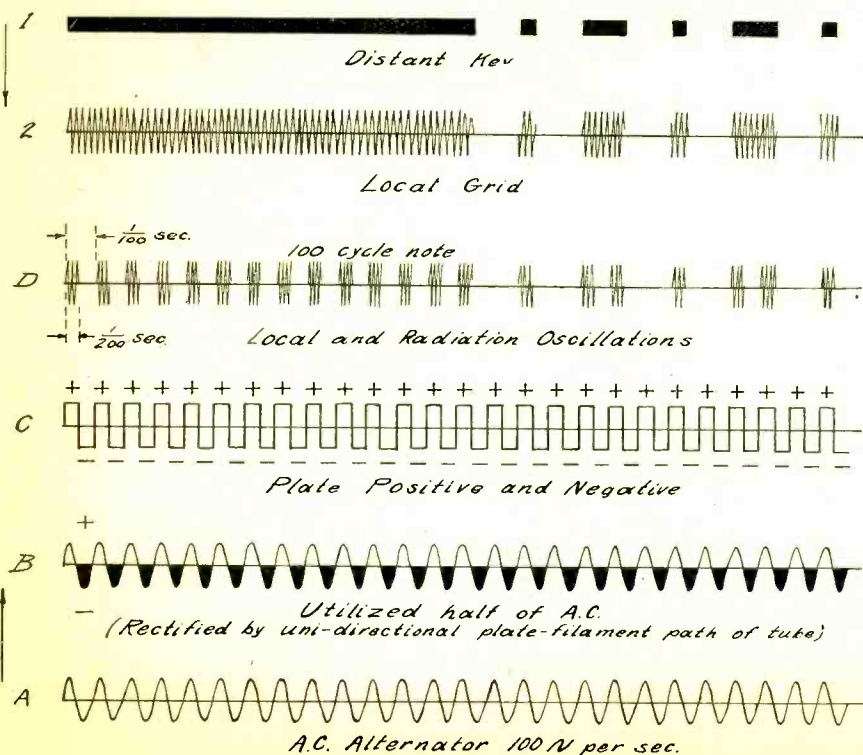

Fig. 3. Illustration of Tube Action

Short Wave Counterpoises

A Discussion of Various Means for Reducing Ground Resistance
With Application to 77-Meter Transmission

By *Gaston B. Ashe*

WHILE the design of an efficient counterpoise or earthing system is fully as important as the design of the antenna itself, this problem has received little attention, so the writer has devoted considerable time in an effort to determine how the earthing resistance of antennas could be reduced by practical and cheap methods. While the results so far have been gratifying it is felt that there is still a long way to go before 100 per cent efficiency is obtained. It is hoped, however, that this paper will induce others to think and experiment along these same lines.

Let us attack this problem from first principles. Fig. 1-A shows an antenna

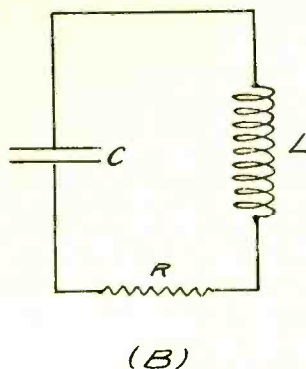
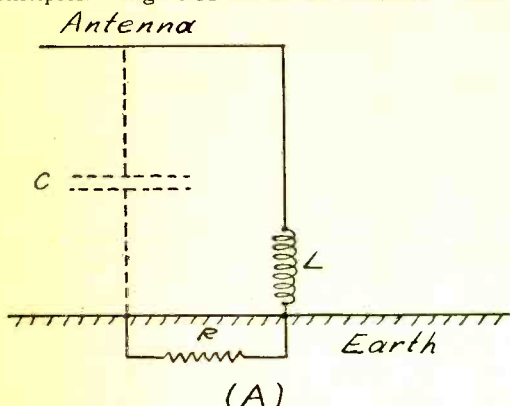

Fig. 1. Antenna and Ground With Equivalent Circuit

with a plain ground connection. The antenna here acts as one plate of a condenser and the earth as the other. However, the current in passing from the lower plate to the station must flow through the earth which has a comparatively high resistance (often exceeding 25 ohms). We may think of this earth resistance as the ohmic resistance R in Fig. 1-A. We then have a circuit equivalent to that shown in Fig. 1-B, i. e., a condenser with a resistance in series.

While at high wave lengths (low frequencies) the effect of a resistance in series with a condenser has a small effect on the efficiency of the circuit, this effect increases as the frequency, and at low wave lengths assumes alarming proportions. At 100 meters (3,000,000 cycles) an antenna having a capacity of .001 mfd. and a ground or series resistance of 20 ohms would have a power factor of .378, i. e., a 37.8 per cent loss, or an efficiency of only 62.2 per cent, neglecting all other losses. This shows the importance of eliminating this ground resistance in some way.

A scheme was devised whereby the earth in the vicinity of the antenna was

divided up into many equal small areas, a ground placed in each area and each ground connected to the station by means of a wire. The current entering the earth was, therefore, not permitted to pass through it for any great distance and hence the earthing resistance was almost entirely eliminated.

A brief description of this system, which is shown in Fig. 2, should be of interest. A symmetrical umbrella type antenna was used, the height being about 30 ft. and the radius of the pentagonal-shaped top having a radius of about 80 ft. This arrangement had about the same fundamental as the average amateur aerial. Earth connections were

made so that the current flow in each wire was the same. It was found that this arrangement had an earthing resistance of less than 0.1 ohm.

Some experimenting was done along these lines, but neither space nor the money was available to build this sort of system exactly. When a flat top was used and only a few earthing stars were placed it was found that the resistance was never lower than when a large counterpoise was used and it was concluded that unless the earth in the vicinity was completely covered with stars this system would not function properly. This was no doubt due to the fact that the energy entering the ground in the area not covered by stars had to pass through the earth to the star-covered area.

Another and probably the most practical method of reducing earthing resistance is by the use of a counterpoise. An antenna working against a counterpoise is shown in Fig. 3-A.

It will be seen here that unless the counterpoise is very large or at a considerable distance above the ground, some of the current flowing from the antenna will enter the ground beyond its limits, pass through the ground and then up into the counterpoise. We will then have a circuit equivalent to Fig. 3-B. While this arrangement is superior to Fig. 1-B it is, nevertheless, far from perfect.

However, by making the counterpoise very large so that the ground in the vicinity of the station is completely shielded, a very low earthing resistance results. In Sweden, a counterpoise of this sort was built, over 1,000,000 feet of wire being used and supported by 500 telephone poles. The earthing resistance at this station was less than 0.1 ohm.

This arrangement is obviously impractical from a construction standpoint and because of the large space required, is

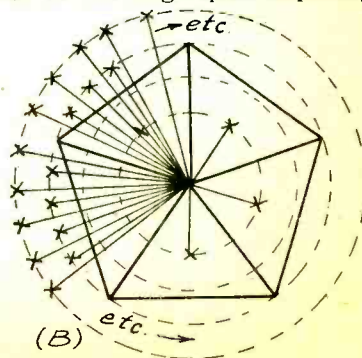
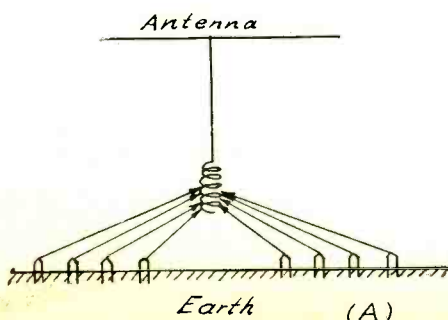
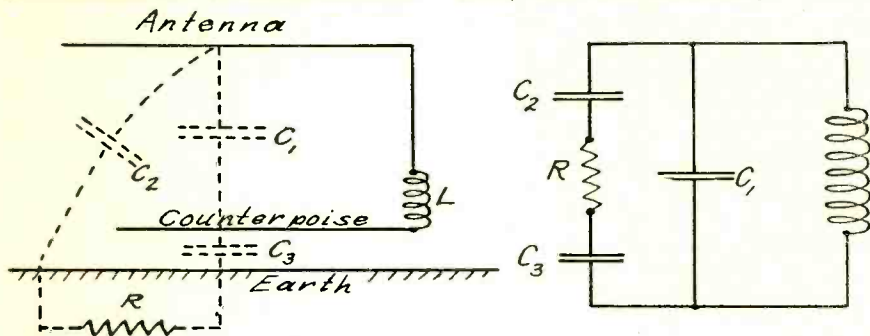

Fig. 2. Multi-Connection Ground

especially so from an amateur standpoint where operations are generally confined within the limits of a 100 ft. x 40 ft. lot with a house on it.

The writer consequently conducted a long series of experiments with a 4-wire and a 2-wire flat top antenna 50 ft. long and 50 ft. above the counterpoise, having a 20 ft. spreader at the far end and a 10 ft. at the near end. The counterpoise was 10 ft. above the ground and the wires 100 ft. long. After numerous changes in the end-spreads of the counterpoise and the addition of as many as 10 wires, it was found that the lowest resistance was obtained with a 2-wire antenna and a four-side counter-



A Fig. 3. Antenna and Counterpoise With Equivalent Circuit B

poise with 100 ft. spread at the far end and 50 ft. at the near end. No. 14 galvanized iron wire gave as good results as copper. The best results gave about 10 ohms resistance on 200 meters.

With the advent of the new amateur bands a new 77 meter system was constructed as described in February RADIO. The antenna consisted of a vertical copper ribbon 50 ft. high with a 3 ft. iron hoop at the top to act as a corona shield and to keep the center of capacity up. The counterpoise on top of the house consisted of 3 iron wires each 30 ft. long and extended in three directions like a star, with the ends open. The counterpoise was approximately 20 ft. above the ground. This system had a fundamental of 70 meters which was brought up to 77 meters by the use of a 3 turn coupling coil. The total resistance at this wave was approximately 20 ohms.

Several attempts were made to reduce this resistance which finally resulted in the reconstruction of the old two-wire counterpoise used for 175 meter transmission as a supplementary counterpoise or earth shield. This large counterpoise was coupled to the antenna inductance by means of a series condenser at approximately the nodal point. It was found that a reduction in resistance of about 7 ohms immediately resulted, with a corresponding increase in radiation of from 2 to 3½ amperes.

The series condenser was not critical and had no appreciable effect on the wave length of the transmitter or antenna system and for this reason it is

thought that its effect was that of a ground shield, which prevented stray lines of force passing between antenna and small counterpoise from entering and passing through the high resistance earth. While few actual measurements have yet been made using this arrangement a sketch thereof is given in Fig. 4 with dotted lines showing its probable action.

It is felt that the following general specifications are in accordance with good practice for short wave antenna construction, as the results obtained at the writer's and at the several other stations conforming to these specifications, have been satisfactory.

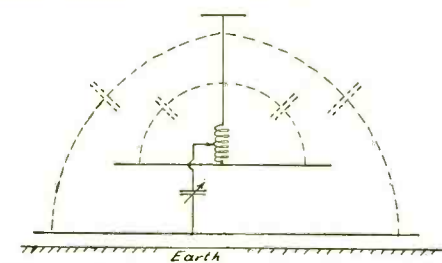

Fig. 4. Vertical Antenna with Counterpoise and Earth Shield

(a) Use a vertical or steeply sloping antenna 50 to 80 ft. high, composed of an iron pipe, copper ribbon or small cage and place a lumped capacity such as a hoop or copper ball at the top.

(b) Construct a 3 to 5 wire radial

counterpoise with ends open and well off the ground (preferably on top of the house) with each wire 30 ft. to 50 ft. long.

(c) Build a supplementary counterpoise or earth shield fairly close to the ground and covering as much area as possible with a few long wires. Couple this to the antenna inductance through a series condenser.

MEXICAN RADIOCAST STATIONS

Of the eleven radiocast stations in Mexico, XICE is the latest. It is located at Chihuahua and is operated by the State, Pedro D. Alvarez being the operator. It is on the air with a musical program from 8:00 to 9:30 p. m. (mountain time) on Wednesday and Friday evenings. Its wavelength is 400 meters.

Other transmitting stations are:

CYA—Partido Liberal Avanzado, 185 meters.

CYB—El Buena Tono, S. A., 380 meters.

CYG—Secretary of War.

CYL—La casa del Radio, 510 meters.

CYO—C. Tarmara, Jr., Monterey, 285 meters.

CYR—City of Mazatlan.

CYX—Excelsior y Cia. Parker, 350 meters.

CYZ—Liga Central Mexicano de Radio, 400 meters.

CZA—Department of Aviation, 530 meters.

CYF—F. Zorilla, Oaxaca.

Don't forget that connections soldered with paste may corrode if not used properly and wiped clean after use.

If you use aluminum wire for the antenna, be sure that it is all in one piece from the end to the set, as if it is not, the connections will be liable to oxidation, with resultant noise.

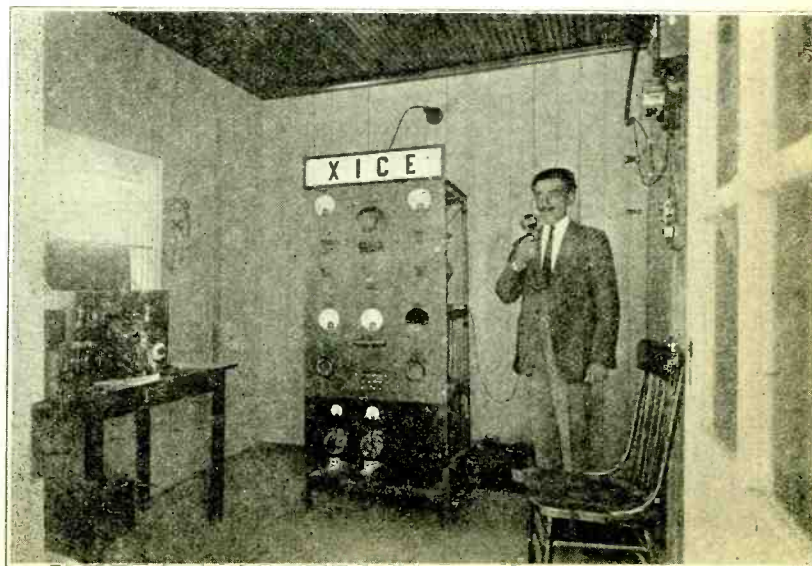

Radio Station XICE

Radiophone Modulation Circuits for the Radio Novice

A Simple Explanation of What is Done by Modulation and How It is Accomplished

By L. R. Felder

MANY novices who began their radio education with the reception of broadcasting are turning their attention to transmission. Radiotelephony is naturally of more interest to the beginner than telegraphy, although the license which must first be secured requires some knowledge of sending and receiving the code. Assuming that this has been secured and the problem of constructing a phone set is ready to be tackled, the question arises as to what type of modulation system to use. There are many circuits for securing modulation, some of them looking very complex and intricate. However there are a few standard ones which are quite simple and may be suited to almost any type of transmitter. In fact most circuits may be reduced to one of these few simple types. It will be the object here to describe each of these modulation systems in simple terms.

The continuous waves generated in and radiated from the antenna have a uniform amplitude, or strength, while speech currents themselves cannot travel through space, the continuous wave oscillations generated at high frequency are able to. If the speech currents are superimposed on them they will carry the speech along with them. For this reason the radio frequency oscillations are called "carrier waves." The object of modulation is to impress the speech waves on the radio frequency waves in such a manner that the speech will be faithfully repeated at the receiving station and will be most efficiently transferred through space. In order that we should hear the exact sound corresponding to the speech wave, the radio frequency waves must be shaped according to this complex speech wave.

The frequency of the radio frequency wave may be 1,000,000 cycles per second, while that of the speech may only be 1,000 cycles per second, which is in the range of frequencies to which the ear is capable of responding, whereas the radio frequencies are far above audibility. The speech wave has not a uniform maximum amplitude or strength. Since it is the speech which we desire to hear and since it is the radio frequency wave which travels to the receiver, it will be understood that the radio frequency wave must be so changed that its shape corresponds exactly with the

speech wave, reproducing the complex form minutely, its maximum amplitude varying exactly like that of the speech wave and at the same frequency as the speech wave, without giving up its own high frequency of vibration, for this high frequency is absolutely essential if the speech is to be transmitted over large distances. This changing of the radio frequency wave is called "modulation" and is accomplished by a modulation system.

If a circuit could be so arranged that the waves radiated from the antenna would have the appearance shown in Fig. 1 our object would be accomplished.

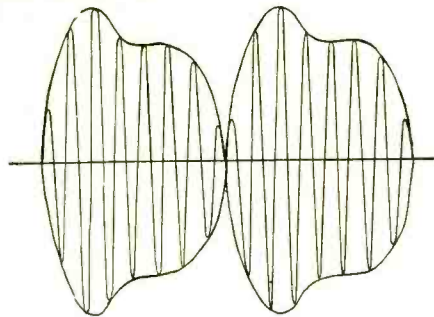

Fig. 1. Radio Frequency Oscillations Enveloped by Speech Oscillations

We have the required radio frequency oscillations, shaped by the speech wave impressed on it. In other words the radio frequency oscillations have been moulded completely by the speech waves so that every characteristic of the speech wave is reproduced, thus giving us an exact reproduction of the sound, and at the same time the waves oscillate themselves at the original radio frequency which enables them to radiate through space. This moulding of the radio frequency oscillations is what modulation accomplishes, and is necessary if speech is to be transmitted by radio. The more nearly the radio frequency wave is moulded in exact accordance with that of the speech the more exact and true will the reproduction of the speech. The actual amount by which the speech current varies the amplitude of the radio frequency oscillations depends upon circuit conditions. The greater the actual change in the amplitude the better will be the modulation, for it is evident that if the amplitude did not change, or only change a little,

no modulation would be effected and therefore speech would not be transmitted. The maximum change which the amplitude can undergo gives "complete" or 100 per cent modulation. If the change in amplitude is less than the maximum for the particular system of modulation we have "incomplete" modulation or under 100 per cent modulation. If complete modulation is had the station will be more efficient and transmit farther than if incomplete modulation exists. However in securing complete modulation there is always danger of distortion. Some amateurs secure complete modulation at the expense of destroying the quality of their speech. It is preferable to have less than complete modulation and have good speech quality, than to have complete modulation and poor speech quality. For although with complete modulation the speech may be transmitted farther when it is received it may not be understood, so that very little is gained thereby. The different systems of modulation suitable for beginners will now be taken up, and the manner in which they modulate will be explained.

In the simplest system which the amateur can employ the microphone is placed as shown in Fig. 2. When the



Fig. 2. Microphone in Antenna

microphone is idle, that is, without impressed sound, the radio frequency oscillations in the antenna have a certain definite amplitude, determined by the resistance of the antenna and the microphone. When it is spoken into, the sound waves strike the diaphragm of the microphone and move it back and forth. This diaphragm bears on the surface of

a chamber containing carbon granules and when it moves back and forth it alters the resistance of the microphone by varying the pressure with which it bears on the carbon. This variation of resistance is proportional to the motion of the diaphragm which in turn is proportional to the intensity of the sound waves striking it. Due to the variation in resistance of the microphone the antenna current amplitude will also vary in proportion as the microphone resistance varies. But we saw that the microphone resistance varies in accordance with the speech waves striking it, therefore it follows that the antenna current amplitude varies in proportion with the sound waves. Hence we have a varying wave similar to that in Fig. 1, since the antenna current follows the speech variations. Thus modulation is accomplished very simply with this system.

Such a system is not suitable for high powers because the microphone has very little current carrying capacity, and since the entire antenna current flows through it, it is only suitable for low power sets under 5 watts, preferably under 3 watts. Thus it is very suitable for beginners contemplating using receiver amplifier tubes in an oscillating receiver operated as a transmitter. The type of microphone used is an important consideration. If the amateur desires good speech his microphone must repeat faithfully in its resistance changes the sound waves. The 25 cent variety is not always the best. A standard make, and they are not expensive as prices are today, should be employed, such as a Kellogg, W. E., or Stromberg-Carlson.

In using the above system certain variations may have to be made, to secure most efficient results. It has been definitely shown that for best results the microphone resistance should be equal to the antenna resistance if directly placed in the antenna. This coincidence is not generally the case so that the amateur will have to alter matters so that this condition is satisfied. This may be done in one of two ways: The microphone may be connected in a separate circuit which is coupled to the antenna coil by means of a coil of a few turns of wire as in Fig. 3. By varying the num-

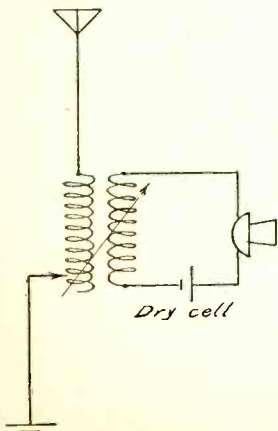

Fig. 3. Microphone in Coupled Circuit

ber of turns in the microphone circuit the most suitable value of the coil may be found. Or the microphone may be shunted with 4 or 5 turns of wire, wound on a small form 1 to 2 in. in diameter as in Fig. 4. The turns may

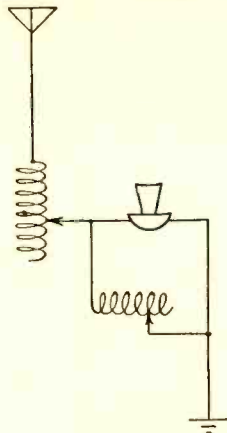

Fig. 4. Microphone With Shunted Inductance

be of bare copper wire spaced so they do not touch each other. By tapping off different numbers of turns shunting the microphone the most suitable value may be found. Other variations of this microphone in the antenna scheme may be found but these are satisfactory for the beginner.

An improvement over the above system is the use of a magnetic modulator, such as that made by the Radio Corporation of America. This has been designed to produce fairly good and high modulation when employed in low power sets. It really is a transformer with a special type of iron as a core. When the microphone is spoken into, the variation of resistance in it alters the current flowing in one winding. This in turn alters the magnetic flux or con-

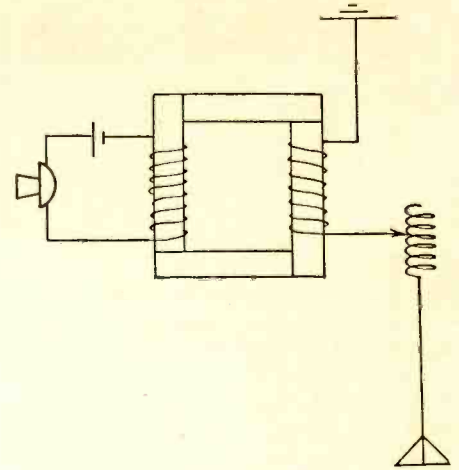

Fig. 5. Magnetic Modulator

dition of the transformer which results in a variation of resistance. Since one winding of this transformer is connected in series with the antenna this resistance variation causes the antenna to vary, as above, and modulation results.

The modulation systems so far considered are the most suitable for the beginner as they are the easiest, least troublesome, and the least expensive. Other systems will give better results but it is best to become acquainted with the simple systems first. The other types of modulation systems will be discussed later.

Don't forget that even if the grid leak is right, that in many cases, a slight reduction on the filament current will often clear up signals just as well as re-adjusting the leak.

When using lead batteries, you will get better results if they are given an occasional overcharge, instead of a few short charges.



What Kin a Feller Do?

Eliminating the CW-Phone Switch

Some Practical Suggestions for Improvements in the Connections of CW Transmitters

By Charles F. Felstead, 6CU

MOST transmitting amateurs know that in a transmitter when two or more tubes are used in parallel as oscillators the grid wires from the grid condenser to the sockets must be of exactly equal length. The plate leads, also, must be connected in such a manner that the wires connecting the socket plate terminals to the radio frequency choke-coil are of exactly the same length. The easiest way to do this is to connect the grid terminals on two of the sockets together with a piece of heavy copper tubing or bus-bar, and connect the wire leading to the set to the exact measured center of this grid joining wire. The same thing must also be done in connecting up the plate terminals of the two sockets.

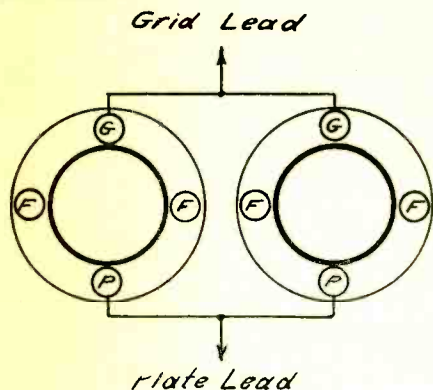

Fig. 1. Method of Connecting Two Sockets

This is shown in Fig. 1 which shows 50-watt tube sockets. If 5-watt tube sockets are used, the grid and plate terminals will be found to be arranged in slightly different positions on the socket. If three oscillators are to be used, considerable difficulty will be encountered in making the grid leads exactly equal in length.

It is much better practice to use an

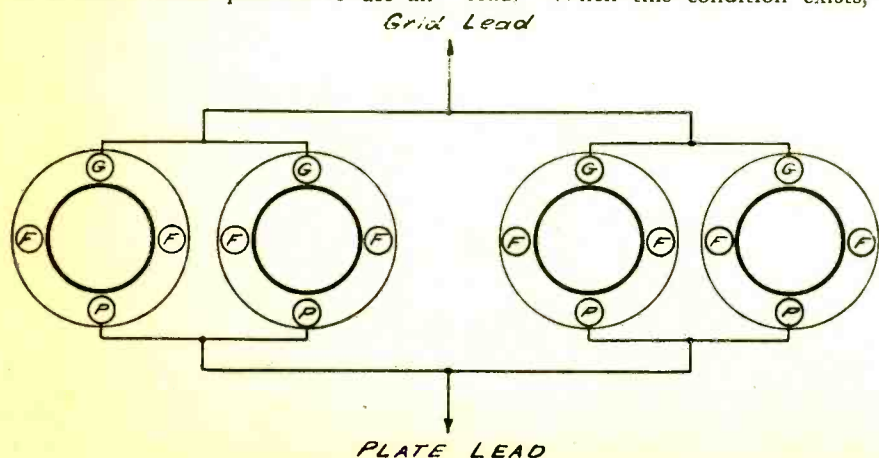

Fig. 2. Method of Connecting Four Sockets

even number of tube sockets even though one socket will not be used. The proper manner of connecting up four tube sockets so that all the grid leads will be exactly the same length, is shown in Fig. 2. The plate leads are also equalized, as will be seen.

When oscillating tubes are properly connected up, as just explained, the electrical connection to the grids of all the tubes are of equal length, and the tubes, if they are of the same type, will oscillate at exactly the same frequency. This means that the tubes will all draw practically the same current—since the tubes nowadays are very nearly uniform—and that each will carry its portion of the load. When this condition exists, we

are getting the maximum output of energy possible for the input, if the insulation of the sockets and the wiring is of the best.

If the grid and plate leads were con-

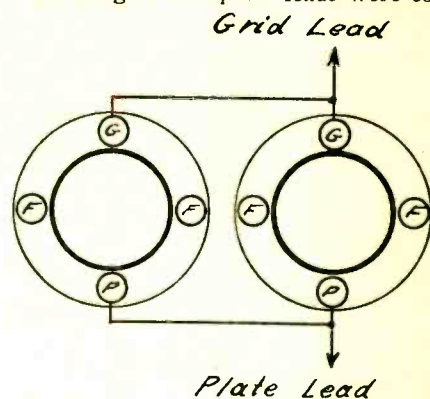

Fig. 3. Improper Method of Connection

nected as shown in Fig. 3, the two tubes would oscillate at slightly different frequencies (that is, different wavelengths), and one of the tubes—the one that was out of resonance with the transmitter—would heat badly, especially if high power were used. The other tube, which would be in tune, would be doing practically all of the work and would remain comparatively cool, for most of the energy, instead of being spent heating the plate of the tube as in the other case, would be fed into the oscillating circuit and radiated. The tube which was out of tune would only be burning up valu-

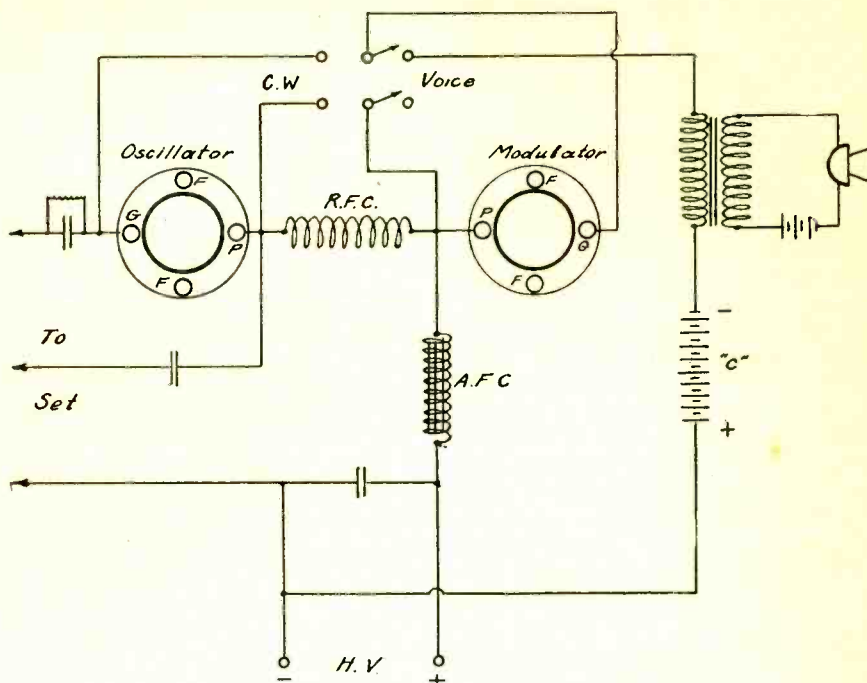

Fig. 4. Circuit Diagram with CW Phone Switch

able energy and doing practically nothing to increase the output of the set. This tube would be better out of the circuit than connected in this manner, for it only helps to lower the over-all frequency of the set.

Efficiency is the biggest factor in amateur transmission and reception, and extreme care must be taken to eliminate all these avoidable losses. A tube that is operating out of tune heats so badly that there is danger that it will flash over and ruin the tube. It is never good practice to operate a tube hot if it can be avoided, for it is only wasting valuable energy and materially shortening its life. When the grid and plate terminals of the tubes are connected up properly, the two tubes should run practically equally hot, and when in this condition they will be working together and giving the maximum output possible. As long as copper tubing or heavy bus-bar wire is used in connecting up the filament circuit, it does not matter whether the filament leads to the tubes are of equal length or not. For the sake of simplicity, the filament connections are left out.

When the design of a CW-phone set is considered, there is always trouble with the switch that connects the modulator tube in parallel with the oscillator when CW transmission is used. No matter how carefully this switch is designed and built, there is bound to be a considerable loss of energy, because it is connected in that part of the circuit where losses are most prone to occur, as will be seen in Fig 4 which shows the hook-up for a set using one of these switches.

Then there is always the trouble of

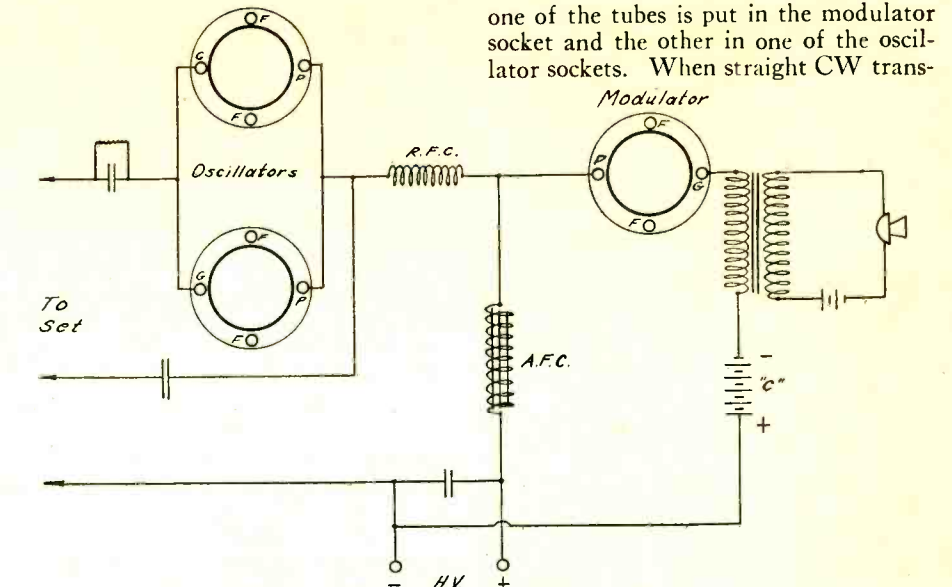

Fig. 5. Circuit Diagram Without Switch

trying to get the grid leads to the two tubes so connected that when the tubes are thrown in parallel for CW the grid leads to the oscillator and modulator tubes will be exactly equal in length. This is nearly mechanically impossible even when the switch is most carefully designed and wired, so the scheme shown in Fig. 5 was devised. This not only does away with the switch and its losses but it also greatly simplifies the wiring of the set, and the only additional apparatus needed is an inexpensive tube socket—assuming that the set is designed for one oscillator and one modulator tube. As will be seen, this extra tube socket is connected in parallel with the regular oscillator socket in the manner shown in Fig. 1.

When voice transmission is to be used,

one of the tubes is put in the modulator socket and the other in one of the oscillator sockets. When straight CW trans-

mission or ICW with a chopper is to be used, the modulator tube is taken from its socket and placed in the extra oscillator socket. This puts the two tubes in parallel as oscillators. The set is now in the most efficient condition for transmission on CW, and avoidable losses have been cut down to a minimum. When the tube is taken out of the modulator socket, the A, B and C battery connections are automatically broken, thus saving the expense of a filament and plate switch.

In Fig. 6 is shown the hook-up of a shunt-feed, inductively-coupled Hartley transmitted with Heising modulation, using the modulator changing stunt described in this article. This is one of the best circuits to use with a low-powered transmitter. If the circuit is

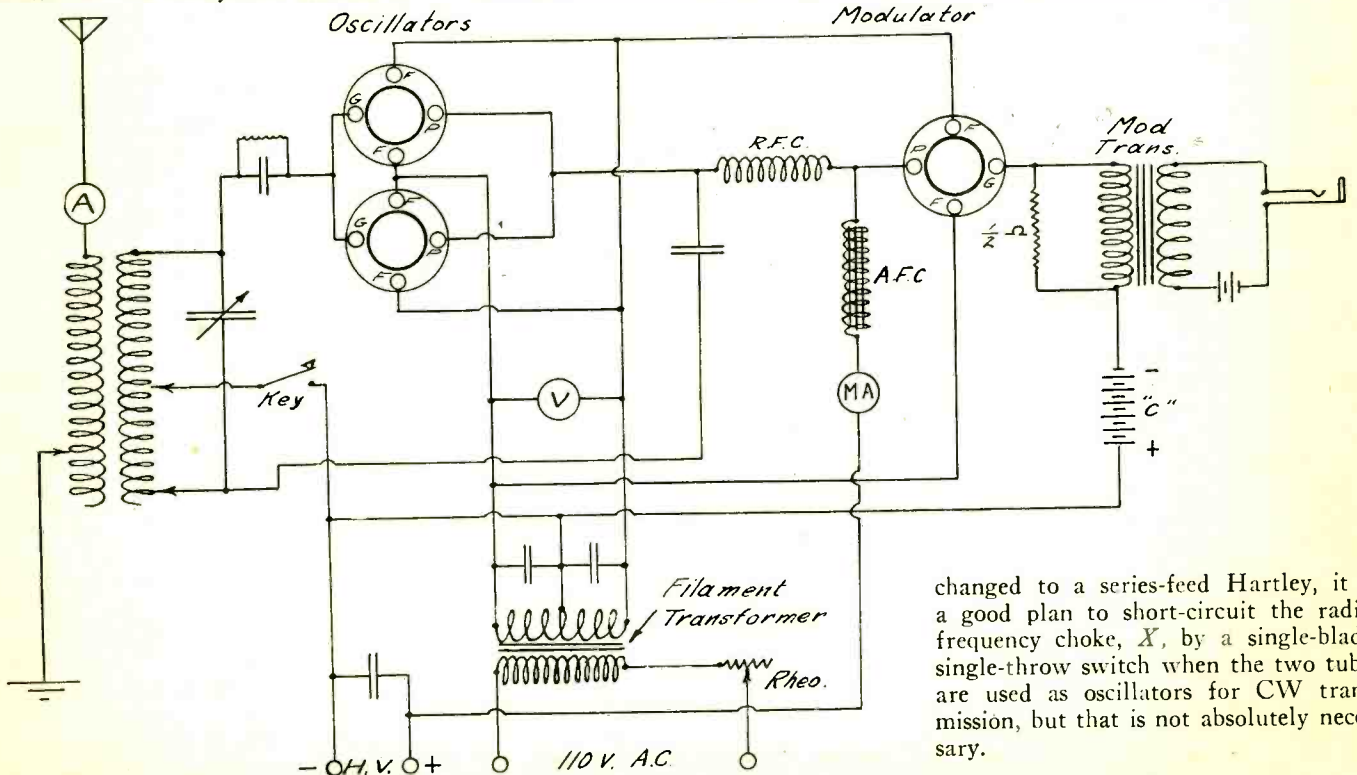

Fig. 6. Circuit Diagram of Shunt-Feed, Inductively-Coupled Hartley Transmitter with Heising Modulation

changed to a series-feed Hartley, it is a good plan to short-circuit the radio-frequency choke, X, by a single-blade, single-throw switch when the two tubes are used as oscillators for CW transmission, but that is not absolutely necessary.

Measurement of Ultra-Radio Frequencies

Detailed Directions for Using an Oscillator and Wavemeter for 1 to 10 Meter Measurements

By Frank C. Jones

SINCE the use of the extremely short wavelengths has become popular, the need of accurately measuring wavelengths of from 1 to 10 meters is evident and can be done readily by using a modified form of Lecher Wire system. The following discussion has to do with a suitable oscillator for very short wavelengths and the use and some of the precautions necessary when taking measurements with parallel wire systems to obtain fairly accurate results, that is to within a small fraction of one per cent.

The oscillator employed in the experiments used a modified form of Colpitts circuit and oscillated quite freely from 1.50 up to 8 meters. The Colpitts circuit is especially adaptable for short wavelengths and the correspondingly high frequencies, because in the circuit as shown in Fig. 1 the usual series

inductor for the stopping condenser so that 1.55 meters was the lowest obtainable due to the length of the leads necessary. The radio frequency chokes were 50 turns of small wire on a 1 in. cardboard tube, four being necessary, two in the filament leads, one in the shunt plate supply and the fourth in series with the grid leak. The stopping condenser keeps the high voltages off the grid and perhaps helps to cut down the capacity between grid and plate, since the smaller the capacity the shorter the wavelength. It was possible to vary the wavelength by about 15 per cent in this manner. The tube was a 5 watter with the base removed by means of a gas flame.

An easy way to find out if the oscillator is working properly is to use about 2 turns in the oscillator for a start and make up a small wavemeter using 1 turn about 2 in. in diameter, in series

have some means of indicating that current is flowing through it. Such a device will be described later.

The theory of standing waves produced on parallel wires is fairly simple. A wave impressed on the system is reflected back after reaching the free end and combines with the next or other impressed waves so that the final effect is stationary waves of voltage and current differing by 90 degrees. The adjustments are quite simple, merely finding the points of maximum current by sliding the shorting link along the wires until the current indicating device shows a maximum value. These points are very sharp as they are based on a condition of resonance and are points of zero voltage and maximum current. The frequency can be found quite accurately from the formula

$$f = \frac{V_0}{2L} (1 - \Delta)$$

f = the frequency in cycles per second.

V_0 = vel. of light in meters per second.

L = distance between max. points of current in meters.

Δ = a small quantity which is a function of the resistance and inductance of the parallel wires at the frequency used. The term Δ does not change the results very much, probably not more than .1 per cent. Details of the calculation of Δ can be found in Bureau of Standards paper No. 491.

As ordinarily taken this formula can be simplified to $f = \frac{V}{2L}$ where V is about .1 per cent less than V_0 .

$$\lambda = \frac{V}{f} = \text{wavelength,}$$

$$\therefore \lambda = 2L \text{ approximately.}$$

By decreasing the measured value of L slightly, say about .1 per cent or less for frequencies above 20,000 kilocycles, a very close approximation of λ may be found. The spacing between wires has very little effect as long as the diameter of the wires is small compared to the distance between them. The term Δ takes up any slight error due to the spacing if it is within reasonable limits, say from 2 to 6 in. or so.

As before mentioned, the shunt to be used across the wires at points of maximum current should be of very low resistance since it will affect the coefficient of reflection of the system and so change the apparent distance between maximum current points. This follows

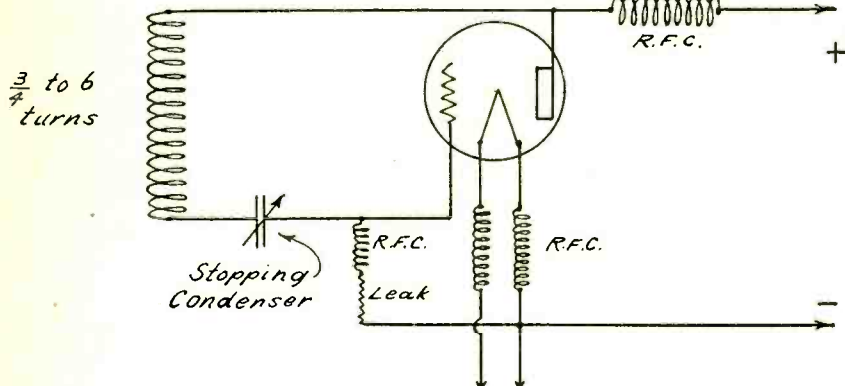

Fig. 1. Modified Colpitts Oscillator

condenser is merely the capacity between the grid and filament inside of the vacuum tube and the wires coming out to the base of the tube.

Using this circuit, an ordinary 50 watt tube was made to oscillate with considerable power output on 4 meters without excessive heating. By removing the base from an ordinary 5 watt tube no difficulty was had in getting down to 1.65 meters.

I believe 1 meter could be reached by using shorter leads and a suitable stopping condenser such as two parallel plates so that the grid lead would connect directly to one plate at the edge of the tube and the tube plate lead describe a partial circle 1 to 2 in. in diameter around to the other condenser plate. The two plates could be about 2 in. in diameter and spaced far enough apart so that the plate voltage would not arc across. The oscillator used here had an ordinary double spaced 10-plate var-

with a 4 or 5-plate condenser and a flash-light lamp for an indicator. If the oscillator isn't working, obviously there is little danger of burning out the lamp. However, if the oscillator is constructed carefully and normal voltages used, it will probably work the first shot. The wavemeter can be calibrated directly in meters from the parallel wires and is just the thing for that 5-meter band.

The parallel wire system itself consists of two 20 ft. parallel wires separated from 2 to 5 in., No. 14 bare copper wire being quite suitable. One end is closed by means of a short loop to which the oscillator is coupled and the other free and insulated from the supports. The wires should have a clear span between supports with no nearby objects which, if moved during the readings, would change the capacity between wires. The short-circuiting link used in finding the points of maximum current should be of very low resistance and yet

readily from the relation that the coefficient of reflection $C = \frac{Z - Z_0}{Z + Z_0}$ where Z_0 is the surge impedance of the wires and Z is the impedance of the shorting link. $Z = R + jX$ so, as ordinarily considered, $Z = R$, since the reactive term X is very small for a short straight piece of wire in comparison with the high frequency resistance R , and so we may say that $C = \frac{R - Z_0}{R + Z_0}$ which shows that R should be as small as possible in order to have $C = -1$.

This shows at once that the use of a small lamp as a current indicator even with as small a resistance as an ohm or so, will change the coefficient of reflection and so throw out the measurements entirely. As a practical example of this a measurement was taken using a wavelength of 1.75 meters which was checked quite accurately with the thermocouple and galvanometer method. Using a 2.3 volt flash-light lamp and moving from hump of current to the next gave an entirely different apparent wavelength as did using a shorting link of copper wire on the first hump and a lamp on the second hump. The apparent wavelength in the first case was 1.45 and the second 1.66 meters which are way off and yet articles have appeared in various magazines recommending the use of flashlight lamps for the indicators or small hot-wire or thermocouple meters which may have even greater resistances.

The most accurate method is to use a straight short piece of copper wire and connect a delicate thermocouple in shunt to part of it as in Fig. 2. A 6 ohm thermocouple was shunted across $1\frac{1}{2}$ in.

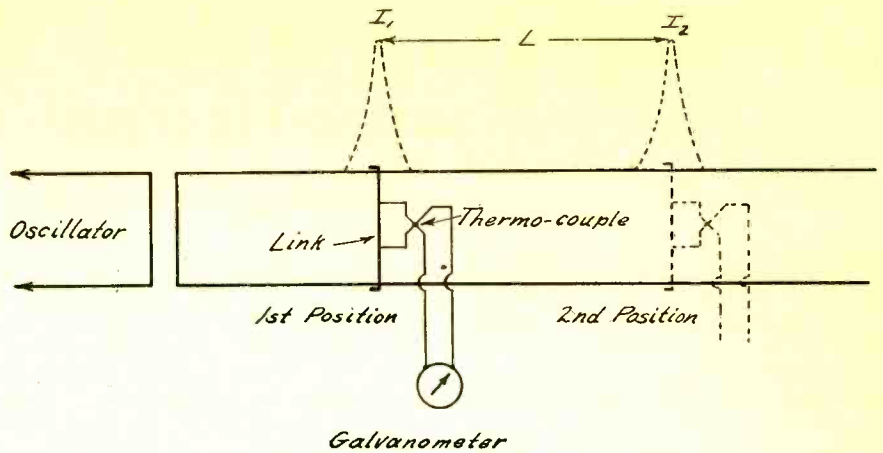

Fig. 2. Accurate Method of Measurement

of a straight 4 in. shorting link of No. 14 copper wire in the device used here and the two leads from the thermocouple brought away perpendicular to the parallel wires out to a telescope and moving mirror type of galvanometer. Only an extremely small portion of the current will flow through TC , most of it flowing through the fairly low resistance copper wire shunt.

The actual procedure in taking readings using the thermocouple and galvanometer method is to set the oscillator near the closed end of the parallel wires and then slide the shunting link with the thermocouple along the wires, starting near the closed end, until the first point of maximum current is found. This point is marked and the next point found, and the distance between these points measured in meters. This distance in meters is the term L in the formula and is approximately equal to

one-half of the wavelength of the oscillator.

Another point in taking accurate measurements, the parallel wires should not extend out more than a quarter of a wavelength beyond the second maximum current point for best results. A convenient method of moving the points of maximum current along the wires without changing the distance between them is to connect a small variable condenser across near the shorted coupling end of the wires. If the resistance of this condenser is negligible the effect in causing any error in the measured distances will be negligible. However for precision work no condenser should be used because the resistance of any condenser at such high frequencies is liable to be very high. It is necessary to put an extension shaft and knob on the wave-meter dial so that it may be adjusted from a distance.



Radio Cabinet for Best's 45,000 Cycle Super-Heterodyne, Constructed by W. G. Varney, Dover, N. H.

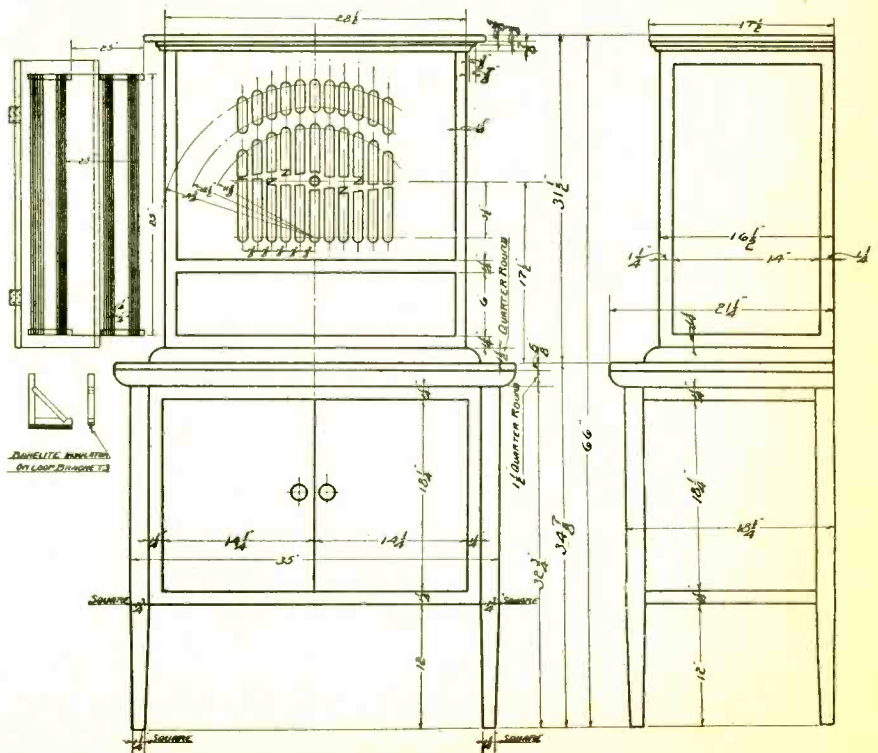

Constructional Details of Mr. Varney's Cabinet

Modifications of Best's 45,000 Cycle Super-Heterodyne

By Thomas L. Kennon

THE sensitivity and selectivity of the 45,000 cycle super-heterodyne can be increased by careful manipulation of several additional controls which I have devised for this purpose. While these add such complications in the construction and operation of the set that they should be tried only by an experienced person, results have justified the changes. I claim loud speaker reception of ESP, Paris, 2LO, London, and Buenos Aires on a loop in California.

The modifications include the use of "A" tubes in all but the three stages of I. F. amplification, the addition of two filament rheostats (one in the oscillator circuit with a milliammeter and one

in the detector circuit with voltmeter), the use of a $4\frac{1}{2}$ - $7\frac{1}{2}$ volt C battery in series with a center tap of the loop, and push-pull amplifier in the second audio stage. A complete system of shielding is employed and panel control is provided for the Midget feed-back condenser and oscillator coupler.

This set, unlike the original, requires a storage battery for filament supply, the voltage for the small tubes being kept down by a Cutler-Hammer resistance in series with the rheostat, with a voltmeter shunted across the filaments. The oscillator plate voltage has been found to be best at 90 volts. All shielding is connected to the -A and all -A leads

are taken from the shielding thus considerably shortening the wiring. All leads are made as short as possible.

The additional parts required over and above those originally specified by Mr. Best are a larger panel, ($7 \times 31 \times \frac{1}{4}$), a larger baseboard ($8 \times 30 \times \frac{1}{2}$), vernier dials for the condensers, a 0-300 milliammeter, two 25-ohm rheostats, C-H 25-ohm variable resistance condenser and aluminum sheet for shielding.

Constructional directions, other than as shown in the schematic wiring diagram, are unnecessary to anyone having sufficient skill to undertake to make these changes in the original layout.

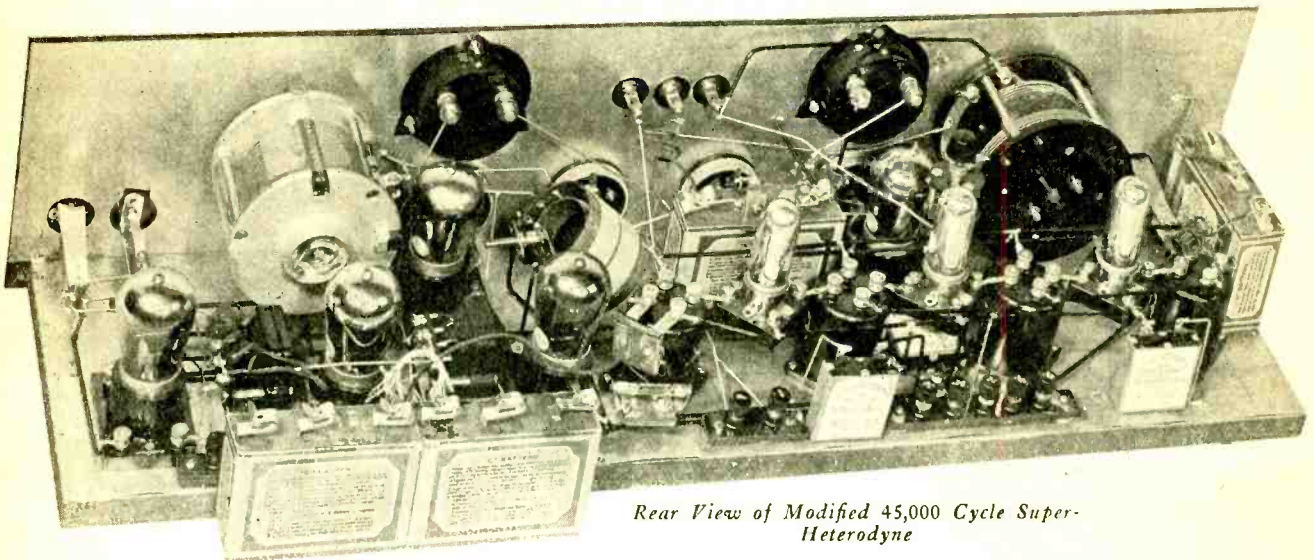

Rear View of Modified 45,000 Cycle Super-Heterodyne

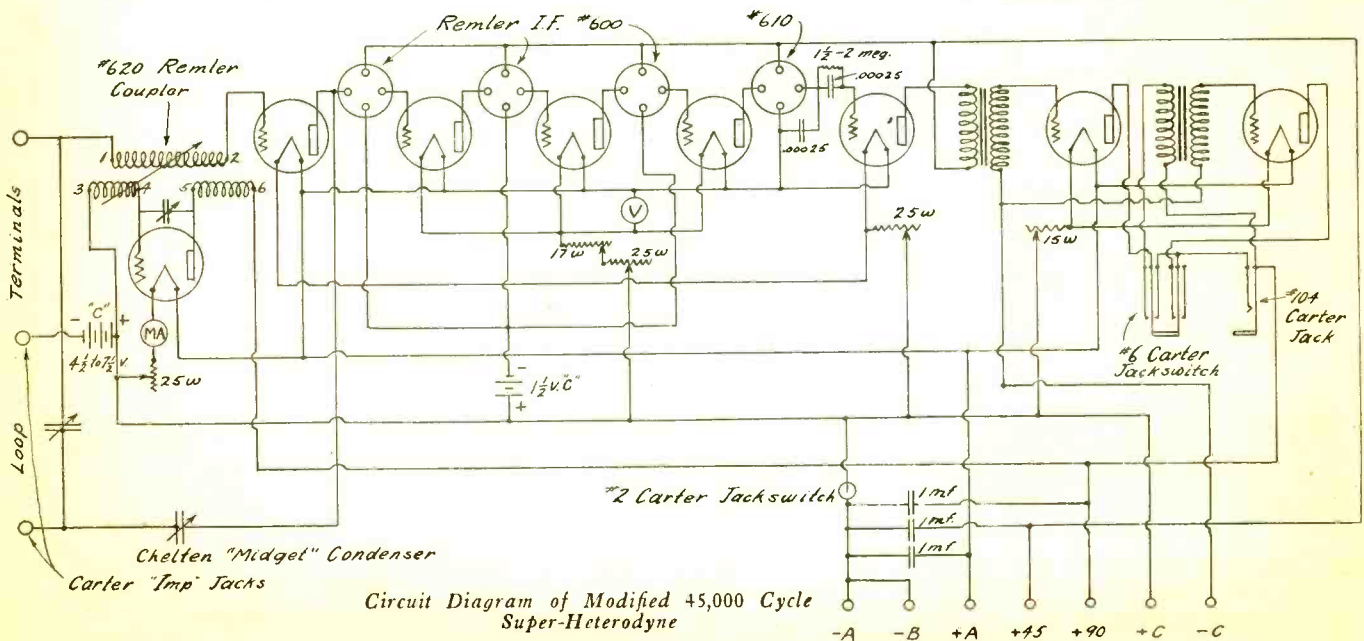

Circuit Diagram of Modified 45,000 Cycle Super-Heterodyne

Rebuilding the CR-9 for Short Wave Reception

Structural Changes Giving an Unusually Efficient Receiver

By R. McGinnis, 8D7T

MANY a good receiver, which will not oscillate below 200 meters, can be rebuilt so as to receive the short waves now being used by amateurs and radiocasters. Among these is the Grebe CR-9 which is the favorite of many amateurs for DX work. Its effective wave range lies between 185 and 3,000 meters. Desiring to get the lower wavelengths I determined to rebuild the set.

The left hand coil is removed entirely from the set, but the right hand coil is left intact except for the removal of all except 21 turns. On removing these turns, start from the center of the frame and remove them carefully one by one. Great care must be used so as not to displace the turns not removed from the stator frame.

Next revolve the tickler into such a position that, working from the center

Under the variometer frame will be found a connection from the shield to the positive *A* of the detector socket. Remove this and replace with a lead from the end of the coil to which the rotary plates of the condenser are attached, to the positive *A* on the detector socket. A lead is then run from the grid condenser and leak to the other end of this coil. By connecting the outermost end of the stator coil, or the end next to the sockets, to the grid condenser and leak, the lead will be found to be very short. In my case this lead did not exceed 2 in. in length.

A coil of five turns of heavy insulated wire, such as No. 2 d.c.c., wound on a 4 in. tube, then removed and bound with thread to make it self supporting, constitutes the primary circuit. This is untuned and receives its energy by shock excitation. Leads are run the coil ends to the aerial and ground posts on the panel.

Although some may differ in the placing of the primary coil relative to its inductive relation to the secondary coil, I found that with my antenna system and proximity to natural "Q.R.M." the coil worked best when placed against the left hand side of the variometer frame with its windings running parallel to those of the secondary coil. Oscillations were more easily controlled due to the loose coupling thereby produced and tuning was extremely sharpened. For the complete hook-up, consult the sketches. Nothing is unusual in the circuit, it being the common two circuit regenerative with tickler feedback.

If your Grebe is one of the first released, resistance of the secondary circuit may be considerably reduced by removing the excess insulation in the end plates of the condenser as shown in Fig. 2. This will be found unnecessary if your set is of the late design as this loss has been taken care of by the manufacturer.

These changes do not involve any alteration of the amplifier. The detector seems to work best with 30 volts on the plate of a hard tube.

Reception of short waves can be secured with the Best 45,000 cycle superheterodyne by some slight changes in the oscillator-coupler. For wavelengths from 50 to 200 meters remove all but 12 turns on each side of the center tap of the stator and take off 5 turns from the grid coil.

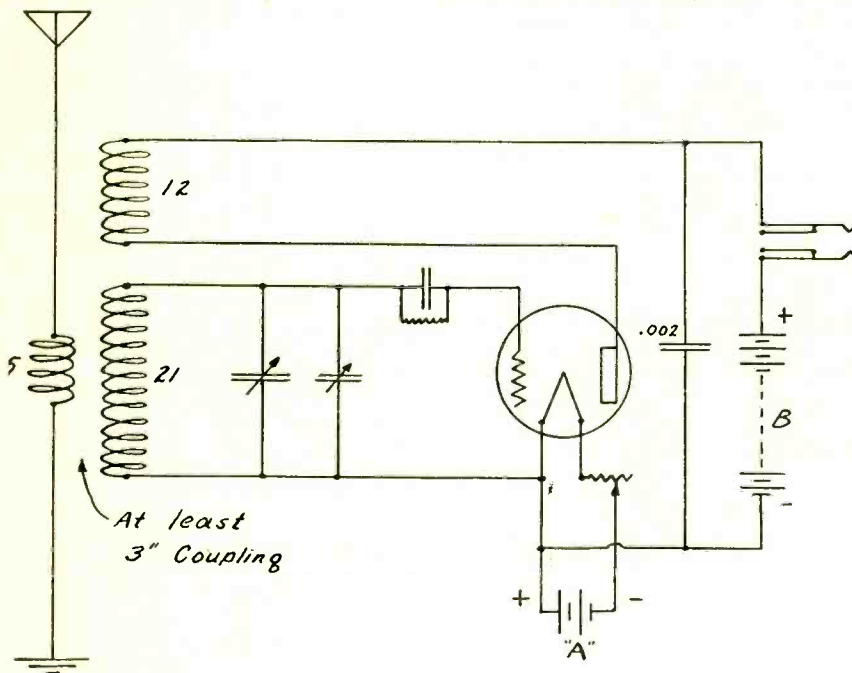

Fig. 1. Wiring Diagram

I first removed the bank wound coil attached to the variometer form by unscrewing the four bolts holding it. This coil may be saved for future use, but holds no place in the set about to be built. Next all the taps were carefully unsoldered from the coil just removed. These, too, are not of any use in the new tuner. By exerting a little pressure on the left hand stator coil of the variometer, it may be released from the frame.

of the ball out on both sides, turns may be removed until there are but six on each half of the rotor. Connect these windings together as they were previously.

The connections to the variable condenser are then removed. From the rotary plates, connect a lead to the stator coil which still remains fastened in the variometer frame. From the stator plates of the condenser, connect a lead to the other end of this coil.

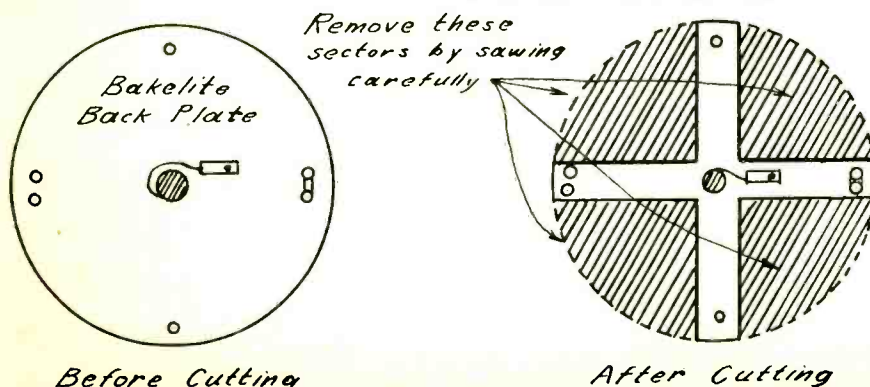

Fig. 2. Change in Condenser End Plates



QUERIES *and* REPLIES



Questions submitted for answer in this department should be typewritten or in ink, written on one side of the paper. All answers of general interest will be published. Readers are invited to use this service without charge, except that 25c per question should be forwarded when personal answer by mail is wanted.

In the circuit diagram for the improved 45,000 cycle super-heterodyne published in January RADIO, condenser C_5 .0025 mfd. capacity is shown connected from the secondary of the tuned transformer to the plate of the detector tube. Is this correct?—A. R. F., Los Angeles, Calif.

This condenser is not connected as you describe, if you will examine the diagram carefully. The condenser is tied between the plate and the positive filament of the detector, thereby shunting the primary of the first audio transformer and the B battery. In the text, mention is made of shunting the primary of the transformer only, but it was

considered advisable to have the condenser by-pass the radio frequency around the B battery also. The grid of the second detector tube is connected to the positive filament through the grid leak and the secondary of the tuned transformer. A diagram showing plainly just how the connections are made is shown in Fig. 1.

I would like to have the circuit diagram of an inexpensive 5 watt transmitter, which could be adapted to the use of

a C-301-A tube when low power is desired.—H. S. Brocton, N. Y.

A good circuit for a 5 watt transmitter, employing either a 350 volt storage battery, or a rectifier, as desired, is shown in Fig. 2. If the C-301-A tube is used, either a storage battery will have to be provided for lighting the filament, or a filament heating transformer will have to be wound with taps, so that a voltage of either 5 or 8 can be had for the two sizes of tubes. With the C-301-A tube, the plate voltage should never exceed 120 volts.

I am using a 3 tube, 3 circuit receiver, which I tune in with the whistle, but when I turn back the tickler, I get no volume. I might add that the whistles are very strong. How can the volume be increased?—A. F., Canton, Ill.

Apparently you are a strong member of the "blooper" fraternity. Every time you tune in a station by causing the detector to oscillate, you are contributing a loud whistle to the others in your neighbors' receiving sets. The best method to avoid making such interference is to mark the dial settings for the different stations on a chart, and then you will not have to use the tickler coil each time to find the station again. If the set does not regenerate well, but oscillates when the tickler coupling is close, you may have a fixed condenser of the wrong capacity bridged across the primary of the first audio frequency transformer. The detector tube may be old and has lost most of its electronic emission.

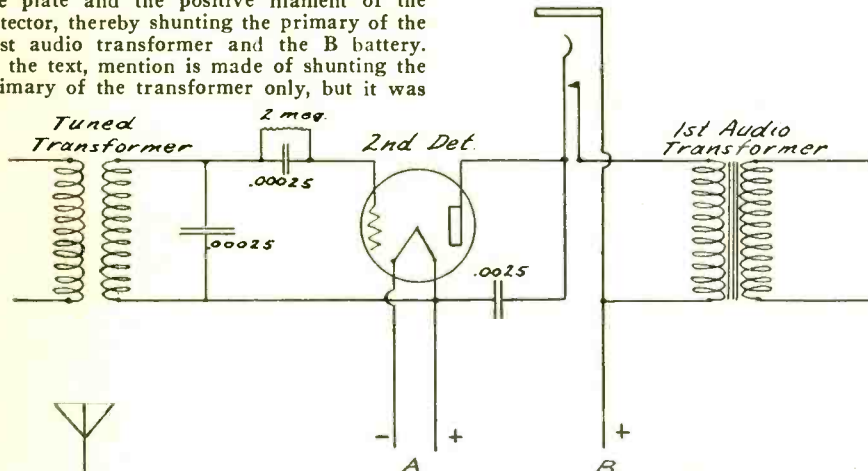

Fig. 1. Connections of Detector Tube in Super.

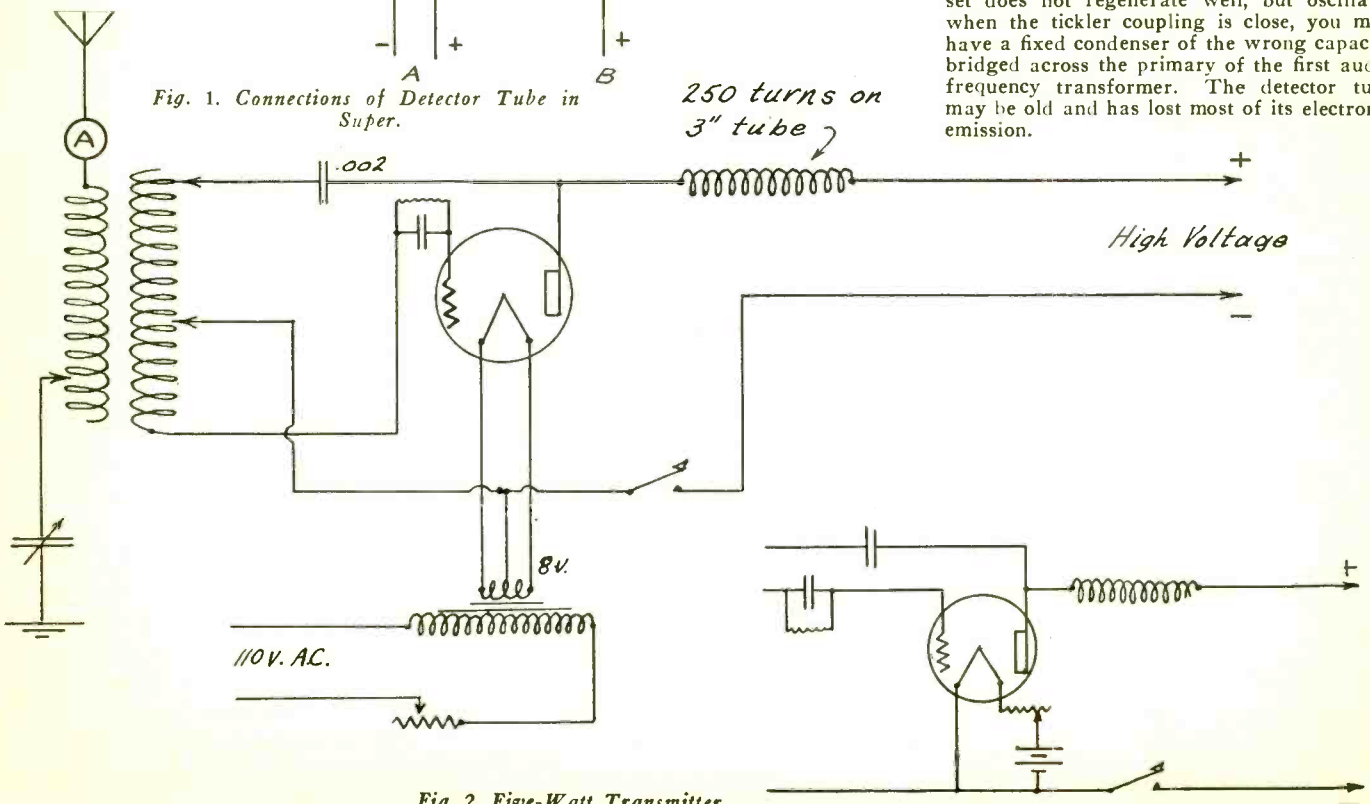

Fig. 2. Five-Watt Transmitter.

I have a plate variometer with load coil attached, a grid variometer, and a variocoupler. Would spiderweb coils be superior to the above? Please publish a circuit for either of the above sets of coils, with a two stage audio frequency amplifier.—W. S. M., El Monte, Calif.

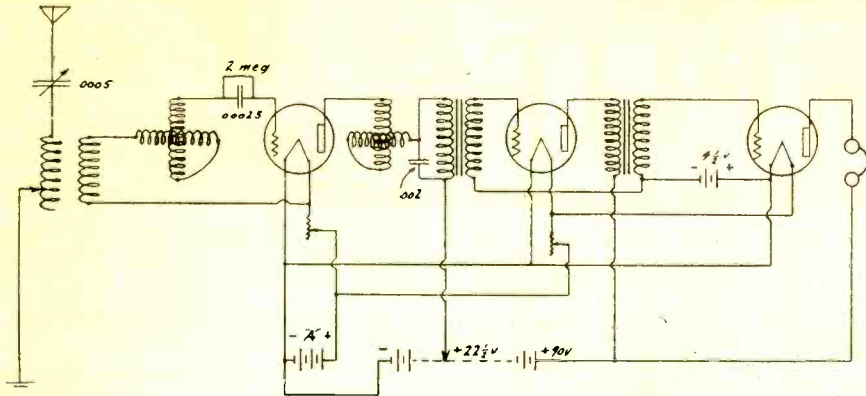

Fig. 3. Three-Circuit Regenerative Tuner with Variometer Control.

The coils you have are for the more or less obsolete three circuit regenerative tuner with variometer control. We are showing the circuit as requested, in Fig. 3. We doubt if the spiderweb coils would be any better, if as good, as the apparatus you now have.

Could a one stage radio frequency amplifier be added to the Improved 45-000 cycle Super-Heterodyne described in January RADIO?—D. G., San Francisco, Calif.

It is a relatively simple procedure to add a single stage of transformer coupled radio frequency amplification to the set, although the results obtained would not be appreciably greater than with the standard arrangement unless an extra high grade transformer was used. In Fig. 4 the arrangement of apparatus for the special amplifier, 1st detector and oscillator is shown, the rest of the circuit being omitted on account of lack of space.

Which would be the best method of increasing the range of my crystal set? Adding an audio stage, replacing the crystal with a tube, or adding a radio stage? Would a one-tube reflex circuit be satisfactory?—J. V. R., Glassport, Pa.

A single tube reflex receiver would be the best combination you could use. This circuit has been so popular with our readers that we are reproducing it again, in Fig. 5, although it was published a few months ago. A good grade of tuned radio frequency transformer should be used, and an audio fre-

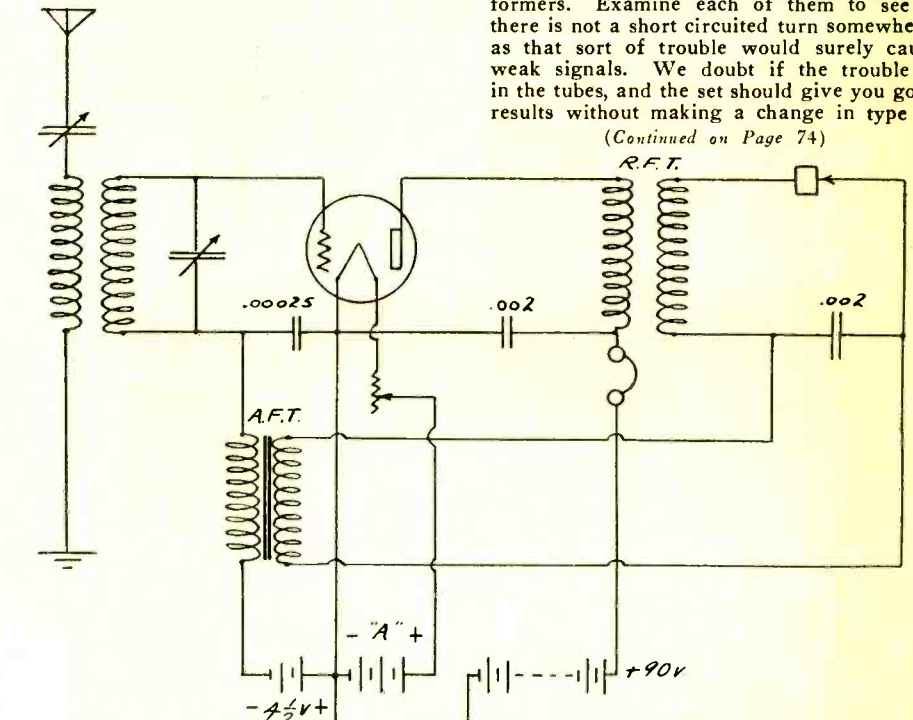

Fig. 5. Single Tube Reflex.

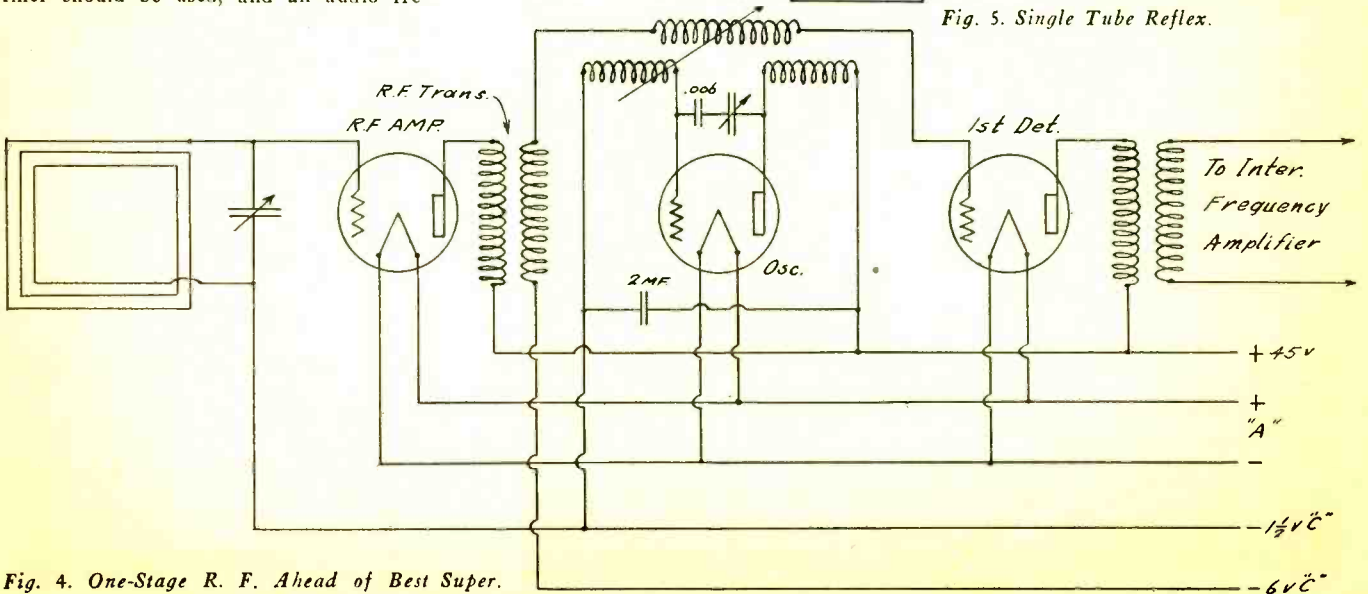

Fig. 4. One-Stage R. F. Ahead of Best Super.

quency transformer of low turns ratio, preferably 2:1, will give the best tone quality.

Can the interference eliminator described in January RADIO be used in connection with a Neutrodyne receiver. Will this increase the range of the set?—B. F. S., Oakland, Calif.

Interference eliminators, taken as a whole,

are unreliable, apparently working well on one set, or type of set, and proving of no use on other sets, in the same location. Most interference eliminators cut down on the signal strength in the same proportion that they cut down the interference and consequently are of no value. One of our contemporaries recently conducted a contest for an interference eliminator that was a success. The contest was a failure, as out of the hundreds of devices submitted, not one could pass the tests which a good interference eliminator should be able to pass. Our suggestion is to try the interference eliminator on your set, as only a practical trial will tell you whether it will be of assistance, or not.

Please print a diagram of how to build a transmitter using one UV-201-A tube.—C. W. L., Syracuse, N. Y.

This hook-up is shown in Fig. 2.

I have a Ware Neutrodyne receiver. Below 400 meters it does not work. Is there any way I can increase the volume? I am using UV-199 tubes and 3 dry cells for the A battery. Could I substitute some other tube and increase the number of dry cells?—W. H. C., Freehold, N. J.

If you cannot tune below 400 meters, something is wrong with the neutrodyne transformers. Examine each of them to see if there is not a short circuited turn somewhere, as that sort of trouble would surely cause weak signals. We doubt if the trouble is in the tubes, and the set should give you good results without making a change in type of

(Continued on Page 74)

With the Amateur Operators

AUSTRALIAN 3 BQ

Australian station 3BQ operated by Max Howden at Box Hill, Victoria, has not only established two-way communication with British G2OD but has also worked a large number of U. S. stations as shown by the cards in the picture. The transmitter circuit is a 3-coil series fed Meissner. Plate supply at 1500 volts is secured from a home-made transformer and is rectified by 104 jars electrolytic and a Philips Z₁ tube passing about 100 milliamps.

The aerial is a 50 ft. 5-wire cage suspended between two 80 ft. masts. A 5-wire tapering cage lead-in, 80 ft. long, comes from the center of the horizontal cage and is connected to the set by 1x1/16 in. copper strip. The counterpoise consists of six 100 ft. wires on 15 ft. spreaders, the wires being bunched at the center to form a double fan. The receiver consists of detector and one stage of audio.

6XAD BACK ON THE AIR

Lawrence Mott, 6XAD-62W has returned to Catalina from a trip to Washington and New York and is again transmitting and receiving. While in the East he saw many new developments in the Western Electric, R. C. A. and Naval laboratories and stations. He expects to have a 2KW water-cooled W. E. tube on the air in a short time. Stations worked during December and not previously reported include:

Iabf, 1acb, 1yb, 1se, 1ry, 1bep, 1cab, 1lg, 1ii, 2bir, 2bcm, 2atf, 3cyx, 2cqi, 2kx, 2acs, 2acs,

2cel, 2rk, 2kx, 2cgo, 2cyq, 3ccu, 3adq, 3bwj, 3du, 5aqy, 5kr, 7jr, 7dd, 8dfm, 8bdu, 8aly, 8doo, 8dfm, 8dki, 8ben, 8csc, 8doi, 8cct, 8bzd, 8dga, 8axf, 8dal, 8bcu, 8bpl, 8ry, 9dhg, 9cy, 9afy, 9ash, 9ddk, 9dhl, 8dia.

WORK WITH AUSTRALASIA

By 6AWT
FOR JANUARY

Date	Worked	Time
January 7	Z-2AC	12:27 A.M.
" 14	Z-2AC	1:42 "
" 15	Z-4AK	1:55 "
" 17	Z-2AC	12:54 "
" 17	Z-2AP	2:12 "
" 18	Z-4AK	1:08 "
" 18	Z-4AA	1:52 "
" 18	Z-4AA	3:00 "
" 18	A-2GQ	4:36 "
" 18	A-3BD	5:31 "
" 19	Z-2AC	12:22 "
" 19	Z-2AE	1:21 "
" 19	Z-4AA	2:20 "
" 20	Z-4AA	2:12 "
" 21	Z-2AP	12:24 "
" 21	Z-2AP	12:24 "
" 21	Z-2AC	1:07 "
" 22	Z-2AC	6:09 "
" 24	Z-2AC	12:28 "
" 24	Z-2AP	12:54 "
" 26	Z-2AC	12:30 "
" 21	WJS*	12:40 "

*The Rice Expedition at Boa Vista, Rio Branco, Brazil.

8ATX is a 15-watt station on 160 meters, at 508 N. Market St., Canton, Ohio, operated by Donald Cordray who will QSL all cards.

8VE, formerly 8ZAH, is using one 50-watter with an advance synchronous rectifier on 79 meters at 5306 Westminister Place, Pittsburg, Pa. Cards always acknowledged.

8ZE with one W.E. 50-watter (Meissner Ckt.) on 77-80 meters worked 35 West Coast stations and was copied in Europe, Australia and New Zealand during the month. Will be glad to arrange tests or schedules. Would appreciate reports on signals and will QSL all cards.

6CUE is the portable call of 6BJX, E. O. Knoch, 2823 E. 6th St., Los Angeles, Calif. "6BJX for a REAL QSR" is the station motto.

2AGI is operated by Karl Rossbach, 620 Wyoming Ave, Elizabeth, N. J.

CALLS HEARD



By SZE-8GX, Oberlin College, E. W. Thatcher, Oberlin, Ohio.

6aao, 6ac, 6adt, (6afg), (6agk), 6aha, (6ahp), 6aib, (6aiq), (6ajh), 6akw, 6alk, 6alo, (6ame) (6amo), (6apw), 6aqd, 6arb, (6arx), 6ats, (6awt), 6bb, (6bdt), 6bgc, (6bjj) 6bjx, (6blw), 6bnu, 6bny, (6bqw), 6caj, 6can, 6eg, (6cgo), (6chl), (6cix), 6civ, 6cla, (6cmi), (6cnl), 6crx, (6css), (6csw), 6cvm, 6ea, (6eb), 6gc, (6gt), 6lj, 6ne, (6of), (6oi), 6ol, 6pl, (6rm), (6ts), 6vs, 6vo, 6xi, (6zp), 7abb, (7afn), 7afo, 7agi, 7ahl, (7bj), 7fh, (7fq), (7gb), 7gr, 7ij, 7ix, 7iy, (7ku), 7lq, 7ls, 7mf, 7mp, (7nx), 7ot, 7qd, (7sf), (7sp), 7th, (7zm), C5go, (C5an), C5cn, M-BX, G2nm, G2yt, G5lf, P.R., 4SA, NZ 4AK.

Dalite—(6oi), 6zw, (?), 7qd, 7abb.

By Can., 3DU, 424 Horton Street, London Ontario, Can.

1aac, 1aap, 1abf, 1aea, 1ahj, 1ajg, 1ajo, 1ajt, 1ajy, 1ald, 1alr, 1amm, 1ary, 1awo, 1awq, 1aww, 1axn, 1axz, 1azr, 1bbg, 1bcc, 1ber, 1bdh, 1bep, 1biq, 1bjo, 1boa, 1bon, 1bub, 1bzq, 1cax, 1cl, 1cit, 1ckp, 1cme, 1cmp, 1da, 1id, 1ii, 1je, 1kc, 1lw, 1ml, 1my, 1nt, 1py, 1sw, 1vj, 1xak, 1xam, 1xm, 1xu, 1xw, 1xz, 1zz, 2aan, 2adj, 2afo, 2afq, 2ag, 2ahb, 2aja, 2aqb, 2ax, 2axf, 2bbx, 2bgi, 2bjo, 2bqc, 2bqu, 2br, 2bu, 2by, 2cee, 2cef, 2cgi, 2cmx, 2cnm, 2cpa, 2cpk, 2cjo, 2cqp, 2ctq, 2vj, 2cwj, 2ozh, 2czz, 2dd, 2em, 2mu, 2qb, 2wr, 2wz, 2xi, 2xq, 3abw, 3ach, 3adb, 3adq, 3aha, 3alx, 3apy, 3auv, 3ava, 3bdo, 3bfu, 3bhv, 3bmn, 3bms, 3bqp, 3cbl, 3ccx, 3cdv, 3cch, 3ckl, 4bq, 4bw, 4cl, 4db, 4du, 4qh, 4aq, 4fa, 4fg, 4fz, 4gw, 4io, 4it, 4iz, 4jk, 4jr, 4ke, 4kk, 4ku, 4mb, 4mi, 4my, 4ne, 4nj, 4oa, 4qw, 4rm, 4sb, 4sl, 4uk, 4vp, 4xe, 5aad, 5aat, 5abn, 5ac, 5acl, 5acm, 5ads, 5aek, 5aex, 5agj, 5agl, 5ags, 5agv, 5ahj, 5aih, 5ail, 5aiu, 5aiy, 5ajb, 5ajn, 5ajt, 5akn, 5akp, 5alz, 5am, 5ame, 5aom, 5aot, 5ap, 5api, 5apd, 5aqa, 5ari, 5asg, 5ash, 5atx, 5ca, 5ce, 5cv, 5dm, 5ek, 5ew, 5hl, 5ik, 5jf, 5ka, 5lu, 5ov, 5ph, 5qk, 5qy, 5rh, 5sd, 5se, 5sl, 5uk, 5vm, 5xa, 5zai, 5zas, 6agk, 6ajh, 6akw, 6apw, 6arb, 6ats, 6awt, 6bcl, 6dbh, 6bdt, 6bgc, 6bir, 6bjx, 6bka, 6bqa, 6cfz, 6cg, 6cmi, 6cnl, 6crs, 6crx, 6css, 6cto, 6eb, 6fh, 6gt, 6kr, 6kt, 6ms, 6oh, 6oi, 6pl, 6rn, 6ts, 6uw, 6vc, 6xbn, 6xi, 7abb, 7dd, 7ku, 7ls, 7mf, nkf, nver, wbl, wgh, whc, 8's and 9's too numerous.

Canadians: 1ae, 1ar, 1dd, 1ei, 2az, 2cg, 2cl, 2dn, 2fi, 2fo, 3aec, 3aeg, 3afp, 3cg, 3gq, 3kq, 3ly, 3qj, 3tf, 3zt, 4cr, 4fz, 5go, 9al, 9bg.

Bermuda: BER.

Cuba: 2CY.

Porto Rico: 4JE, 4SA.

All cards will be answered promptly.

(Continued on Page 44)

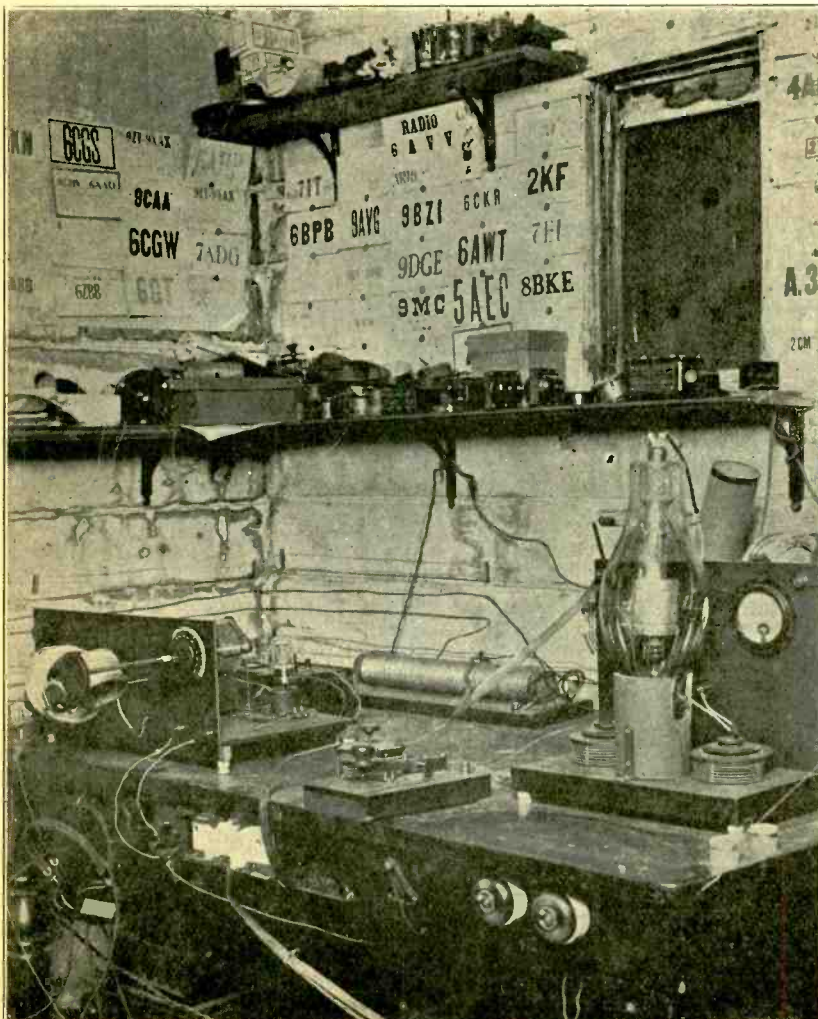

Australian 3 B. Q.

FROM THE RADIO MANUFACTURERS

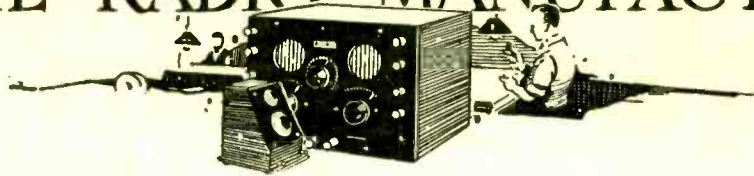

A new 2-amp. Tungar battery charger from the General Electric Co. is so compact that it can be made a part of a radio set inside the cabinet. It charges a six-volt *A* battery at a 2-ampere rate and 24, 28, 72 or 96 volt *B* batteries at any rate up to $\frac{1}{4}$ amp.



without disconnecting the batteries. There is no connection between the 110 volt a. c. supply and the low voltage charging current, an insulating type of transformer being used. This also eliminates danger of grounding the electric light current through the radio set with consequent damage to equipment and possible fire hazard. All bulb connections are brought out through the base.

The MacFadden B-power generator is a half-wave rectifier using one "A" tube and supplies sufficient current for plate supply to as many as six tubes. With its associated



filter it delivers a constant flow of direct current, under perfect voltage regulation and control, when supplied with 110 volt a. c. With a W. E. 216- A tube 60 milli-amperes is obtainable, sufficient for a ten-tube set.

The Eastern low loss coupler combines in one device a primary, secondary and feedback coil. The coils are self-supporting

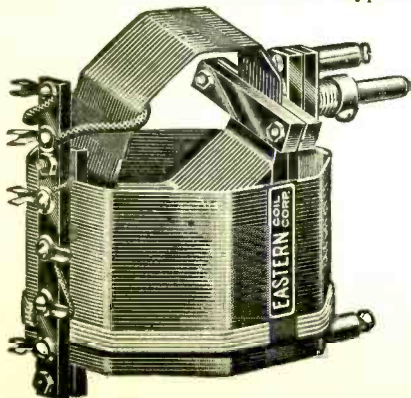

without tube, and are closely wound in octagonal form to give maximum inductance and minimum distributed capacity. The No. 18 coil is double silk-covered and wound without shellac. It has low leakage losses and low conductive resistance. It is made in two types: 40 to 200 meter and 200 to 600 meters.

The Mohawk receiver, previously described in these columns, is now available in either a standard table type consolette as illustrated, or in a console. Both are built with

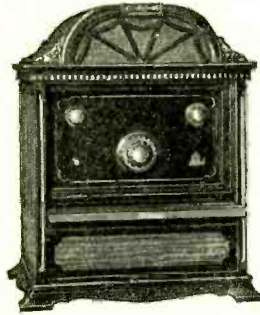

a self-contained loud speaker on top, the consolette with space for *B* batteries and the console with space for *B* batteries, *A* battery and charger. The cabinets are made of 5-ply mahogany in Italian Renaissance style. The receiver has one-dial control and uses two stages of tuned radio frequency, detector and two stages of audio.

The General Radio interchangeable low loss coil, type 277, has known wavelength ranges and inductance valves and is adaptable to many experimental purposes. It is provided with a mounting strip with four holes, whereby it may be readily attached to

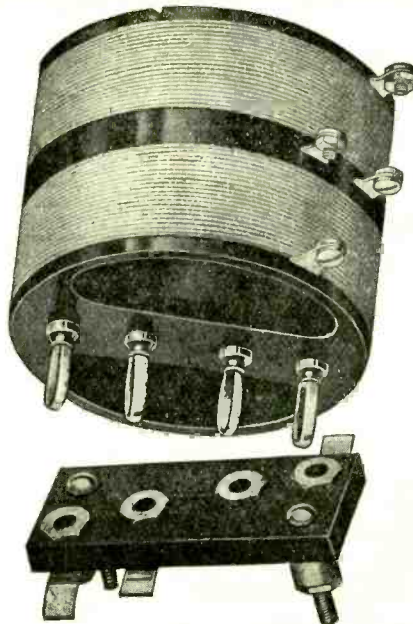

a panel,—bracket or mounting base. Thus it is possible to interchange coils as easily as vacuum tubes. Model 277A with 15 turns and 0.14 has a wavelength range from 50 to 150 meters. Type 277B with 30 turns and .055 mh, from 100 to 300 meters, and Type

277C with 60 turns and .217 mh. from 200 to 600 meters. By using the Model 277C with the General Radio Type 247F and H condensers, having specially shaped plates, and a Type 313 dial, wavelengths in meters may be accurately read from 200 to 600 meters. With the B and A models it is necessary to divide the readings by 2 and 4 respectively. These models may be used interchangeably as a super-heterodyne oscillator for the shorter wavelengths. Other models may be used as antenna coupling coils, coupling transformers for tuned radio frequency, or input tuning coils.

The Bosch Nobattery is a device supplying any plate voltage from 15 to 150 volts d. c. at will when the socket is plugged into a 110-120 volt, 50-60 cycle a. c. circuit. This allows the use of either hard or soft detector



tubes and greatest volume from amplifier tubes. It takes care of any set having from one to ten or even fourteen tubes. Its rectifying elements are not vacuum tubes. Its dimensions are 7x7x12 in. It is claimed to cause no humming or objectionable noise.

The General Instrument Noloss Insolanite Socket has extra large sterling silver contacts arranged so as to be self wiping. The contacts are fixed to heavy phosphor bronze springs insuring a firm, low-resistance connection. The spring members are

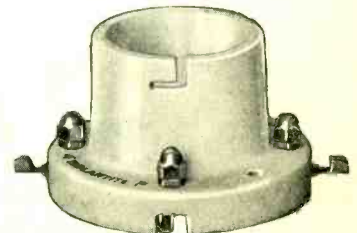
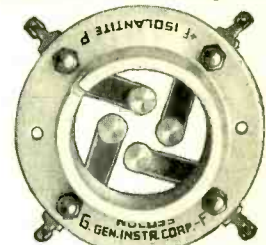

each made of two leaves and are placed to minimize internal capacity. Permanent soldered connections are made to main phosphor bronze spring, at the same time serving as a lug or temporary connections may be made to nuts provided for this purpose.

Be sure ~ that your transformers are giving you Amplification without Distortion

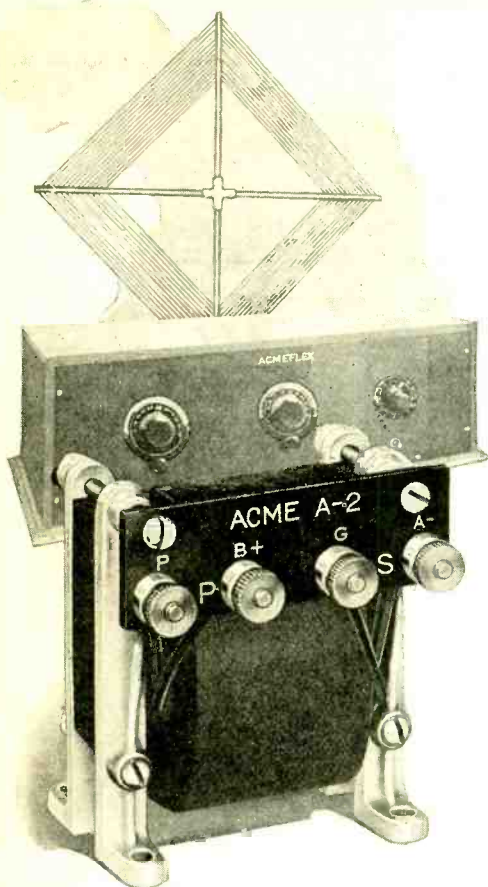

Acme Transformers give maximum volume of sound, clearly and distinctly

WHEN you put a lot of time and money into a radio set you want to be sure that it will give the best results. You want to know that your set will bring in the stations so that you can enjoy listening and be proud to call in your friends. You want Amplification, but above all you want Amplification without Distortion. Be sure to use amplifying transformers that increase the sound without spoiling the quality.

The Acme A-2 Audio Amplifying Transformer is the result of five years of research and experimenting. It gives amplification without distortion to any set. Whether you have a neutrodyne, super-heterodyne, regenerative or reflex, the addition of the Acme A-2 will make it better.

If you are not getting loud, clear radio try Acme Transformers and note the difference.

Each transformer is tested and carries a guarantee tag. If you want Amplification without Distortion use Acme Transformers in the set you build and insist on them in the set you buy. (That's one of the big reasons why the Acmeflex Kitset gives such good results—it uses Acme Transformers). Send for our 40-page booklet, which explains how to get the best results by proper amplification, and also contains a number of valuable wiring diagrams. It will help you build a set. Mail the coupon with 10 cents.

ACME APPARATUS COMPANY

Transformer and Radio Engineers and Manufacturers

Dept. D-2, Cambridge, Mass.

For Amplification without distortion use ACME Transformers in the set you build. Insist on them in the set you buy and enjoy all the year round Radio

The Amplifying Transformer is the Magnifying Glass of Radio.

Have the fun of making your own radio set

ACME

~ for amplification

ACME APPARATUS COMPANY,
Dept. D-2, Cambridge, Mass.

Gentlemen:—

I am enclosing 10 cents (U. S. stamps or coin) for a copy of your book "Amplification without Distortion."

Name.....

Street.....

City..... State.....

CALLS HEARD

(Continued from Page 41)

By **6CJD**, R. E. Smith, Box 33, Merced, Calif.

1bah, 1fi, 1cma, 2ado, 2on, 2caw, 2em, 3agl, 3adu, 3lr, 3ys, 3yv, 4aa, 4da, 4dy, 4fs, 4ft, 5amb, 5ahy, 5bd, 5cp, 5lr, 5tz, 5zav, 5be, 6aan, 6aaq, 6adb, 6adt, 6adv, 6aem, 6afe, 6apl, 6apm, 6asw, 6ave, 6bav, 6bbw, 6bdr, 6bes, 6ba, 6brf, 6bvm, 6cgc, 6cdg, 6che, 6crf, 6crz, 6ckh, 6clb, 6clp, 6dt, 6ee, 6eq, 6gb, 6gc, 6oh, 6qb, 6ru, 6ta, 6sm, 6ta, 6tl, 6tm, 6tn, 6tp, 6tr, all copied in about ten minutes. 7adg, 7aha, 7ahs, 7ais, 7ali, 7av, 7cm, 7dd, 7en, 7gi, 7go, 7iu, 7ls, 7ol, 7qd, 7td, 7tq, 7ys, 8abs, 8ahs, 8ane, 8dja, 8ia, 8td, 9aaq, 9abs, 9ac, 9aci, 9aoh, 9avs, 9bdf, 9bdh, 9bth, 9bb, 9caa, 9caw, 9dwn, 9dyp, 9eal, 9sl, 9bdg. Canadian: 3oh, 4cn, 4cp, 4dh, 5ew, 5fc. All QSL's answered promptly.

By **SAVY**, L. D. Koons, Waverly, N. Y. 4dv, 4ia, 4og, 4qw, 4st, 5aeq, 5air, 5asb, 5hi, 5qk, 5wi, 6bas, 6brf, 6cch, 9adk, 9agn, 9alm, 9ami, 9anz, 9aor, 9ash, 9axh, 9baf, 9bdj, 9bgh, 9bpn, 9bsh, 9bxi, 9caa, 9cab, 9cau, 9ceb, 9erc, 9ctb, 9day, 9dbi, 9deq, 9dkc, 9doo, 9dqr, 9dtn, 9dwy, 9eas, 9eip, 9gc, 9mm, 9ud, 9vc, 9wc.

At **3BVA**, 40 S. Beaver St., York, Penn. 4bq, 4eq, (4fs), (4jr), 4js, 4ku, (4oa), (4sx), (4sa), 4xe, 4pk, 4tw, 5aaq, 5aex, 5alz, (5akn), 5ahd, (5agl), (5atf), 5aot, (5ca), 5ek, 5ka, 5kc, (5in), (5nw), 5lh, (5ov), (5sd), 5zav, (5vm), 6aao, 6ab, (6ac), 6adt, 6afg, 6age, (6agk), 6ahp, 6aiv, 6aji, 6akz, 6ame, 6ao, 6apw, (6arb), (6ase), (6awt), 6bau, 6bv, 6bcl, 6bdo, (6bdt), (6bgo), 6bir, (6bj), (6bjx), 6bka, 6blw, 6bul, 6bnf, (6bql), 6bqr, 6bni, 6bur, 6bvt, 6can, 6ect, 6cdn, 6cek, 6ceq, 6cfs, 6cft, (6cgw), (6chl), (6cjj), (6cjl), (6cmi), 6cnl, 6cmu, 6ers, 6crx, (6ess), 6csw, (6cto), 6czx, 6ea, 6eb, (6ew), (6fh), 6fy, 6gt, 6il, 6it, 6nx, 6of, 6oi, (6pl), (6rn), (6ts), 6vc, 6wc, 6xi, 6xy, 7abb, 7af, (7agj), 7ahl, 7ajy, 7dc, (7dd), (7dj), 7fd, 7fg, (7gb), 7ge, 7gq, 7ij, (7ir), 7jm, (7mf), 7rk, 7zm, 7ze, 7zq, 9aau, (9afz), (9amx), (9amb), (9azl), (9aqg), (9auy), (9bcd), (9bje), (9bht), 9bmv, (9bmk), (9bex), (9bna), (9byl), (9byv), (9bwx), (9bpm), 9cap, (9caj), (9cip), 9cjc, (9ccs), (9czv), 9cxx, (9cmb), (9dac), 9dfn, (9ded), 9dpx, (9dtk), (9dqa), (9eiv), (9ej), 9efy, 9eky, (9egu), (9ehy), (9ep), 9bm, 9ze, 9zt.

Canadian: (4cr), (4eo), (4fv), 4gt, 4io, 5ba, 5gf. English: 2jf, 2kf, 2kz fone and cw, 2nm, 2od, 5lf, 5nn, 6nf. French: 8ab, 8ap, 8go, 8sm. Others: BER, (q2mk), O-bq, O-ba, P9, z2ac.

By **7AHI**, A. L. Kuballa, 4019 47th Ave., Seattle, Wash.

1zt, (1xz), 1ow, (1ii), 1aw, (1aid), 1cpz, 1cmp, 1pl, 1avf, 1bsd, (1amf), (1cme), (1af), (1ajx), 1ber, 2by, (2dn), 2be, 2by, 2da, (2rk), 2xi, (2xq), 2anb, 2bqb, 2brb, 2cbr, 2cee, 2cjr, 2crk, 2cvu, (2wr), 2bgi, 2ka, 2za, 2bqr, 3ab, (3hj), 3hs, 3il, 3mf, 3te, 3sf, 3adp, 3adq, 3aha, (3adb), 3bjp, 3bpp, 3cch, 3chg, 4tj, 4af, 4gw, 4bq, 4bt, 4ux, 5ck, 5ew, (5hi), 5in, 5ka, (5lh), (5lh), (5nw), (5is), 5sd, 5se, 5sk, 5uj, 5ux, (5wy), 5aaq, 5aaz, 5acf, 5aqq, 5aiu, 5aef, 5akh, 5akn, 5aph, 5aqq, 5ash, (5bk), 8er, 8hn, (8jj), 8qw, 8vq, 8wo, 8yv, (8zk), 8abm, 8acy, 8add, 8amr, (8aub), (8awj), (8axk), (8atr), 8bau, 8ben, 8bnv, 8br, 8bvn, (8cpr), (8ese), 8cys, (8dnf), (8dse), (8bkr), 9cjr, (9bcj), 9ev, (9cdv), 9caj, 9eky, 9efh, 9bng, 9cys, 9xi, (9dyz), 9axs, 9nv, 9eas, 9dnf, (9ra), 9dbw, 9eld, 9dwx, 9ded, (9bnk), 9ash, 9aio, (9epm), (9mm), 9aqg, 9csg, 9apm, 9bjl, 9ddp, 9dpl, (9bxb), 9cpe, 9cmp, 9buk, 9fk, 9bdw, 9dun, (9bcy), 9duo, 9bwx, 9et, 9daw, 9cro, 9dur, 9eaj, 9bow, 9dmj, 9cvo, 9cgn, (9ctg), 9bnf, 9eam, 9cdv, (9biz), 9abc, 9bhf, 9dpl, 9dzv, 9ado, 9ddk, 9za, (9bdf), 9evl, 9bmj, 9bh, 9on, 9col, 9dlw. Canadian: 3qs, 3pz, 4cr, (4fv), (5bf). Heard on waves from 70 to 90 meters. All cards answered gladly.

At **9AMX**, Atchison, Kansas 1yd, 2wz, 3bss, 4je, 5ew, 6ape, 7df, 8bsv, 9auw. Canadian: 5bz. Mexican: BX, le, lb, lk. British: 2od, 2nm, 2kf, 6aq. 9amx always QSL's.

By **6BBV**, J. Barsby, 1511 1/2 Common - W. Hollywood, Calif. 1aac, (1bsd), 1cab, (1cmp), (1pl), (1xz), (2apy), (2avd), (2cee), (2cvu), (2hj), (2hq), (2qt), 2rk, (2ry), (3che), (3chg), 4iz, (4ku), (5aic), (5ajj), (5aiu), 5akn, (5aqw), (5hl), (5rh), (5uk), (5chl), (6oo), (6wi), (7mf), (7qd), (8atr), (8bau), 8bww, (8jq), (8zg), (9aju), (9bc), 9bwx, (9cjr), (9csg), (9cp), (9ded), (9dmj), (9dri), (9ky).

(Continued on Page 46)

SUPERIOR



Cle-Ra-Tone Socket

RADIO



Battery Switch

PARTS

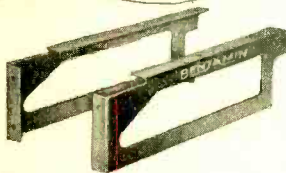

Radio Brackets

FOR



Grid Leak Panel

BETTER

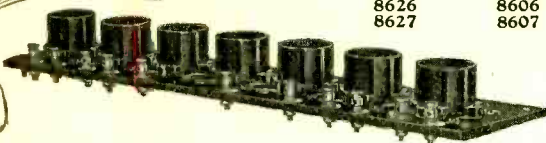

Cle-Ra-Tone Gang Socket and Mounting Shelf

RADIO SETS



Cle-Ra-Tone Sockets
Shock Absorbing—Spring Suspended

Tube holding element "floats" on perfectly balanced springs. Spring supports are not affected by stiff bus wiring. Molded parts of genuine Bakelite. Keeps your tubes sensitive only to the radio waves. Keeps microphonic disturbances, due to jars and vibration, out of the receiving set. The Cle-Ra-Tone Socket marked so great an advance in the mechanics of radio reception that it is the choice of the leading manufacturers of high-class sets, and is recommended by the foremost engineers for their most popular hook-ups.

8645 For Standard Base Vacuum Tubes, \$1
8646 For UV-199, etc., Tubes..... 1

Radio Battery Switch

Lightest and neatest switch made. Mounts in single 1/4 inch panel hole. No spacer washers required. Push-pull single contact features give positive contact. When it's in it's off, avoiding accidental cutting in of battery.

No. 8640, \$0.30

Radio Bracket

Gets the wiring out of sight. Adaptable for standard cabinet mounting.

No. 8629, per pair, \$0.70

Grid Leak Panel

With the bracket, provides a safe, secure mounting for this important element.

No. 8632, each, \$0.15

Cle-Ra-Tone Gang Socket and Mounting Shelf

Simplifies construction of the larger receiving sets, and may be used with most of the latest hook-ups. Consists of Cle-Ra-Tone Shock-Absorbing Sockets attached to Bakelite mounting shelf with set of binding posts and markers. There is adequate space for mounting of accessory equipment.

Standard VT Sockets	or UV-199, etc. Sockets	Dimensions of Shelf	No. of Sockets	
8613	8603	7 7/8" x 4 1/8" x 1/4"	3	\$5.50
8615	8605	17 1/4" x 4 1/8" x 1/4"	5	10.50
8626	8606	17 1/4" x 4 1/8" x 1/4"	6	11.25
8627	8607	17 1/4" x 4 1/8" x 1/4"	7	12.00

Ask for Benjamin Radio Products at your dealer's or write us

Benjamin Electric Mfg. Co.

120-128 S. Sangamon St., Chicago
247 W. 17th Street New York
448 Bryant Street San Francisco

You Should Subscribe for "RADIO"

CARTER "ONE-WAY" Plug—50c

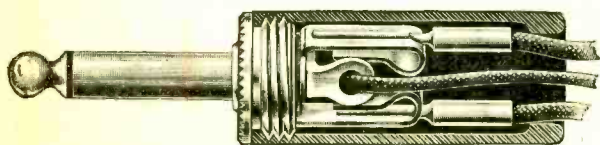

50c

There is only one way to get a plug as good as Carter's and that's to insist on getting a Carter.

Coast Distributors:
Atlantic-Pacific Agencies Corp.
204 Rialto Bldg., San Francisco, California



Any dealer can supply

In Canada
Carter Radio Co., Limited, Toronto

DE FOREST LEADS AGAIN

Another jump ahead!

Just out—first in 1925

DE FOREST'S greatest triumph. A truly remarkable advance in ease of operation—beauty of tone—selectivity—distance range. It uses tube detector.

You should see and test this instrument before you buy any set. Its refinements and improvements are too many to tell here.

Ask your nearest De Forest dealer to bring it to your home and show you how simply and perfectly it operates. It will be hard for you to let him take it away.

Price Range \$125 to \$200
F. O. B. Jersey City, N. J.

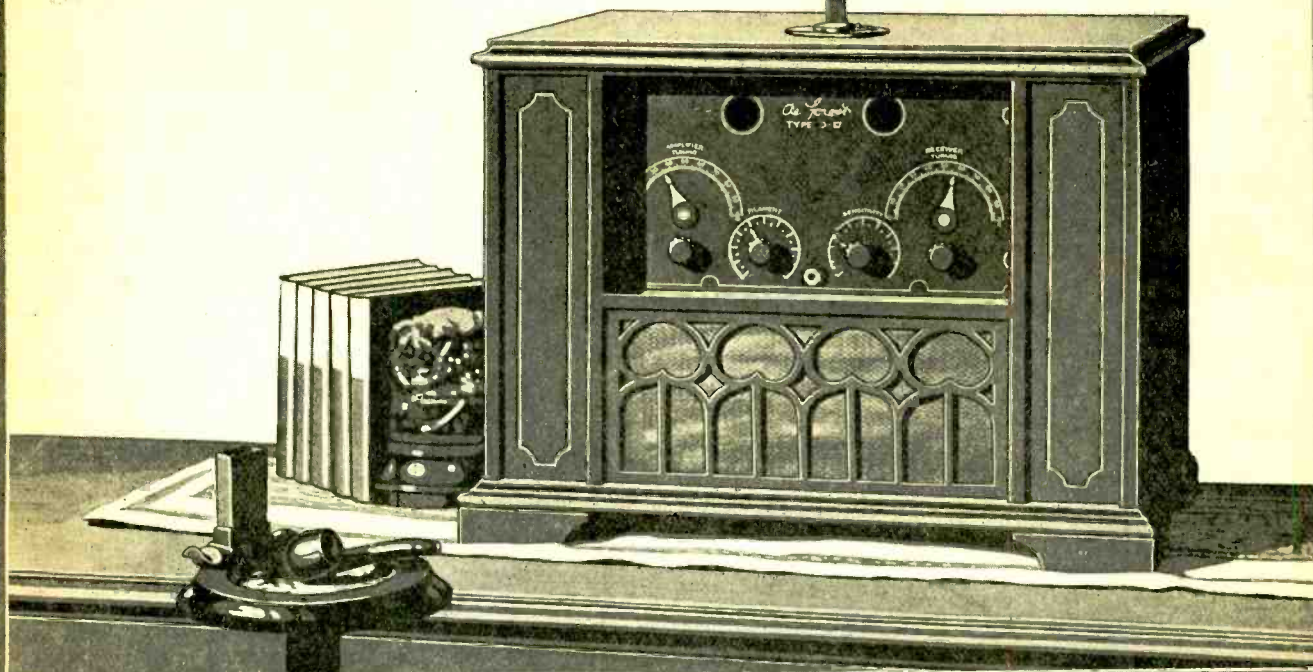
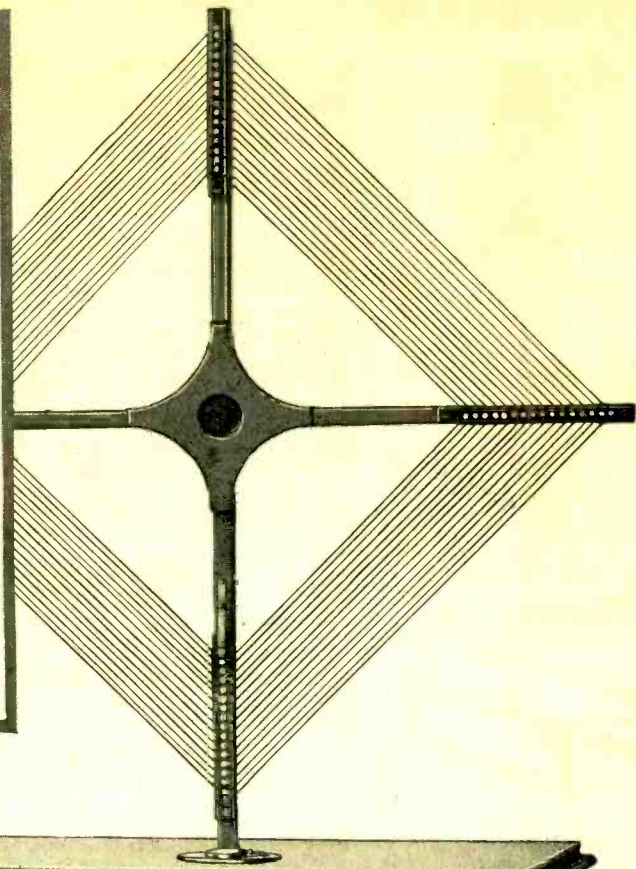

THE NEW DE FOREST D-17

REG. U.S. PAT. OFF.

Made by De Forest Radio Company, Jersey City

MAGNAVOX Radio

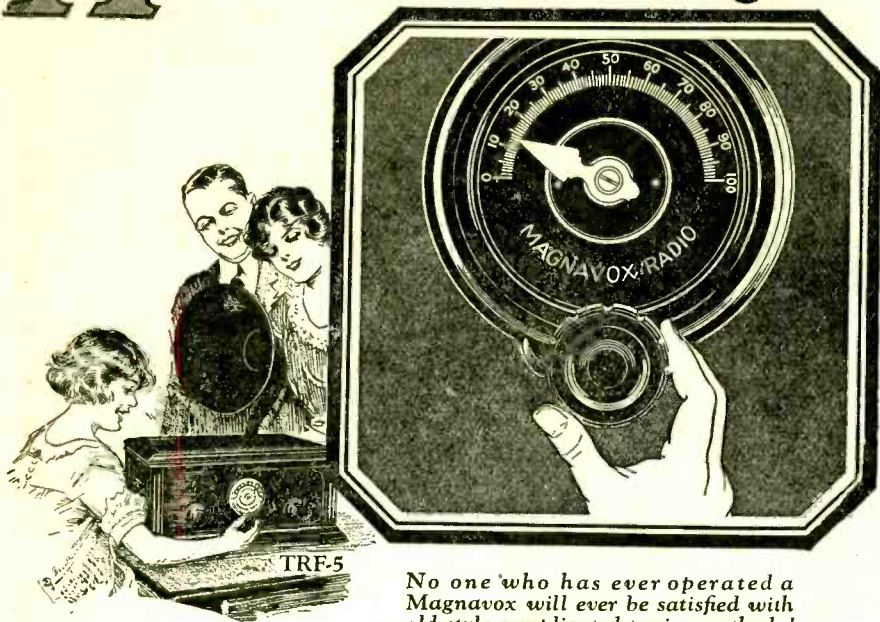

No one who has ever operated a Magnavox will ever be satisfied with old style complicated tuning methods!

ONE hand on ONE dial For Tuning In!

EVEN though the Magnavox single dial Station Selector has displaced the "old style" complicated tuning arrangements, this remarkable feature *alone* would not have merited the praise which every owner gives his Magnavox Set.

It is by its sheer *musical quality*, in addition to its unusual simplicity, that the Magnavox 5-tube tuned radio frequency circuit retains the user's lasting admiration.

As pioneers in the design and manufacture of radio reproducers, Magnavox engineers were thoroughly equipped to master the problem of beautiful tone.

If you already own a receiving set, a Magnavox Reproducer will wonderfully enhance its daily usefulness for family and friends.

Have nearest Registered Magnavox Dealer demonstrate these Receiving Sets and Reproducers today.

THE MAGNAVOX COMPANY OAKLAND, CALIF.

NEW YORK: 350 W. 31st St. CHICAGO: 162 N. State St.
Canadian Distributors: Perkins Electric Limited
Toronto, Montreal, Winnipeg

TRF-50
\$150

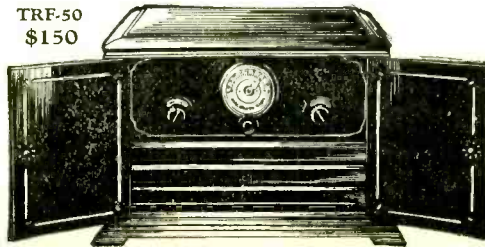

Magnavox Receiving Sets

TRF-5 (as illustrated) encased in carved mahogany cabinet; price includes M4 Reproducer \$125.00

TRF-50 in carved mahogany period cabinet with dust-proof doors and built-in Magnavox Reproducer. \$150.00

Semi-dynamic Reproducer

M4—the most efficient unit ever designed to operate without external battery. \$25.00

Electro-dynamic Reproducer

The original radio reproducer, famous throughout the world. With Volume Control.
R3, \$35.00
R2, \$50.00



3R

(Continued from Page 44)

By SATX, Donald Cordray, 508 N. Market St., Canton, Ohio

1aam, laap, laby, (lafy), laii, lajd, lajf, lajm, laiw, lams, laqz, larh, lavl, laye, lbkk (lbik), lbjn, (lbiz), lbym, lbx, lbqe, lbtt, lcdp, lcdz, lha, lli, lsf, lium, lcaz, lnt, lez, (lced), lced, lum, lwn, lww, lza, lzs, lzk, (lbik), 2afo, 2aar, 2aah, 2aaz, 2aba, 2abt, 2acd, 2ach, 2acn, 2acs, 2aum, 2adu, 2aqb, 2ale, 2ay, 2ayp, 2abo, 2bbx, 2bck, 2bec, 2bdl, 2bec, 2bjo, 2bol, 2byg, 2bqt, 2cdh, (2cdp Qra) 2cgt, 2cor, 2cpd, 2crj, 2cvj, 2czm, 2fq, 2gz, 2iq, 2lm, 2ry, 2sy, 2wz, 2xbi, 3afq, 3aky, 3al, 3apq, 3as, 3ava, 3avl, 3awu, 3cbo, 3bml, 3brf, 3bv, (3bvl), 3brf, 3bvn, (3ccu), 3cdm, 3ed, 3fp, 3gg, 3gw, 3iu, 3kp, 3kq, 3lv, (3na), 3og, 3ol, (3qw), 3rp, 3so, 3sp, 3tr, 3ud, 3uy, 3uz, 3vw, 3zo, 4cw, 4dv, 4eg, 4ik, (4lo), (4ma), 4og, 4rz, 4sl, 4pd, 4pk, 4qf, 4qv, 4rr, 4tj, 4vn, 4xe, 5am, 5be, 5ago, 5amf, 5acm, 5aek, 5agj, 5cl, 5lv, 5pe, 5qg, 5qh, 5wi, (5qn), 5vi, 5vv, 5xa, 5ab, 5ac, 5gu, 5lv, 5rn, 5ao, 5aac, 5blw, 5cto, 5cgs, 7ij, 7mf, 7hg, 7lw, 7zu, (9alm), 9aaf, 9aaw, 9abx, 9aci, 9adl, 9adr, 9adx, 9aef, 9aif, 9ajw, 9akb, 9akk, 9ala, 9aoo, 9arf, 9aro, 9arr, 9ash, 9bal, 9bax, 9bbe, 9be, 9ben, 9bbh, 9bjf, 9bmk, 9bpc, 9brv, 9wv, 9bvw, 9byy, 9cau, 9caw, 9ce, 9ceb, 9cgr, 9cow, 9cva, 9ck, 9cm, 9dcp, 9dgl, 9dhl, 9dhw, 9dib, 9diz, 9dma, 9dmx, 9my, 9dny, 9dp, (9dpc), 9dro, 9dte, 9dtl, 9dxi, 9eac, 9ebj, 9edl, 9eih, 9eip, 9el, 9elr, 9ez, 9fi, 9ra, 9fe, 9np, 9iz, 9mm, 9gg, 9sp.

Phone: 1kr, 1bjn, 1cke, 1bjm, 2afg, 2iq, 3bos, 3qw, 3bhy, 3bof, 4ik, 5ais, 5amf, 5ado, 8aif, 8axu, 8dme, 8dfa, 8dhe, 8cbz, 8ayw, 8dt, 9abx, 9bem, 9dcm, (9dpt Olatha, Kan.), 9ba, 9mm, 9gg.

Canadian: 1ef, 2bq, 3ly, 3ws, 4rc, 4cr, 9dg, 9bg.

At GBUII, Salt Lake City, Utah

laf, llw, 2aan, 2ag, 2 by, 2cee, 2cix, 2kf, 2ng, 2zb, 3bgh, 3bwj, 3cee, 4sk, 4lj, 4vr, 4mb, 5apy, 5ajt, 5asd, 5atx, 5ew, 5sd, 5lh, 5qy, *5xa*, 5zai, 6ase, 6alw, 6ac, 6ajd, 6agk, 6app, 6bsc, 6bdv, 6bur, 6bt, 6bac, 6buf, 6bss, 6que, 6cny, 6cva, 6wt, 6crb, 6eb, 6fy, 6rn, 6jp, 6wt, 6qd, 6zh, 7afn, 7gb, 7gm, 7ku, 7lr, 7mf, 7mg, 7nm, 7nt, 7dj, 7se, 8bfg, 8htl, 8cmi, 8do, 8vq, 8vt, 8wa, 8xb, 8xk, 8zg, 8zz, 9acm, 9bnn, 9bnk, 9bji, 9bkr, 9bna, 9cjc, 9cak, 9cjt, 9cjs, 9cfi, 9cuo, 9ddk, 9dxy, 9daw, 9diy, 9duo, 9ear, 9emh, 9qw, 9xbg, 9zt, 9zy, C5ef, C5cn, LPX, NKF, —FEASN 4efv, 25 meters QRA?

Mexican: 1b.

By M. O. Smith, 504½ North Adams St., Glendale, Calif. 6BPQ

1aao, 1ach, 1af, 1akk, 1all, 1amf, 1axz, 1bes, 1bie, 1bis, 1bkw, 1bvl, 1eru, 1li, 1lw, 1ml, 1py, 1rd, 1uw, 1xav, 1xm, 1yb, 2afp, 2agw, 2az, 2bgi, 2bkr, 2cee, 2cty, 2cvs, 2cyw, 2cyx, 2dn, 2fc, 2kf, 2rx, 2le, 3ajd, 3alx, 3bfq, 3bg, 3bpm, 3bss, 3buy, 3cc, 3chc, 3cin, 3jh, 3ot, 3te, 3tf, 4bl, 4er, 4do, 4eh, 4eq, 4gw, 4gx, 4kl, 4mi, 4pd, 4pk, 5acf, 5afu, 5ail, 5ajm, 5ajt, 5akz, 5apy, 5auy, 5asb, 5ash, 5asz, 5bs, 5ca, 5ik, 5lh, 5ls, 5nw, 5ot, 7aib, 7aip, 7au, 7dc, 7di, 7dj, 7fm, 7fq, 7gb, 7gj, 7gm, 7ho, 7jr, 7mb, 7mp, 7oy, 7qf, 7un, 7zq, 8aa, 8abm, 8afn, 8ame, 8apr, 8avd, 8bbi, 8bbw, 8bcp, 8bdk, 8bjv, 8bjz, 8bk, 8btl, 8buk, 8cl, 8cvt, 8dae, 8dal, 8dan, 8dfk, 8dkw, 8dph, 8dsn, 8ef, 8ih, 8kc, 8ow, 8rg, 9aki, 9amx, 9ana, 9arr, 9awt, 9bcw, 9bdf, 9beu, 9bf, 9bgh, 9bhi, 9bhy, 9bwb, 9bzw, 9cak, 9cdo, 9cej, 9cfe, 9csg, 9cyk, 9czo, 9dad, 9db, 9dbz, 9dek, 9del, 9dix, 9diy, 9dng, 9dpr, 9dyz, 9eib, 9eji, 9eld, 9en, 9ep, 9hn, 9mi, 9mm, 9ny, 9on, 9sr, 9vc, 9vz, 9zta, nerki, nqz.

Foreign: LPX, gra?, pse qsl.

Mexican: 1b, 9a.

Argentine: MAL.

New Zealand: z2ac.

Canadian: 2be, 2bg, 2cg, 3bp, 3co, 4bb, 4cr, 4dq, 5ba, 5bf, 5ct, 5ef, 5hc.

By SVE, 5306 Westminster Place, Pittsburgh, Pa.

4eb, (4eq), (4fg), (4ke), (4mi), 4ne, (4si), 4tj, 4tw, 4xe, 5aex, 5ajy, (5abn), 5ail, 5ew, (5lu), 5nn, (5ov), 5qy, (5vc), (5vv), (5uk), 5za, 5zb, 5zav, 6aao, 6ab, 6adt, 6agk, 6ahp, 6alk, 6alv, 6alw, 6apw, 6aqd, (6arb), 6aro, 6ase, 6auf, 6awt, 6br, 6bdt, (6beb), (6bft), 6bgc, 6bjx, 6bka, 6bqa, 6br, 6bra, 6buh, 6bur, 6cae, 6cax, 6cej, (6cft), 6cfz, 6cgo, 6cgw, (6chl), 6cjj, (6cmu), 6cnl, 6css, 6ctn, 6cto, 6czx, 6ea, 6eb, (6fy), 6gt, 6lj, (6lv), 6of, 6oi, 6pl, 6ts, 6vc, 6vd, 6xi, 6zh, (7abb), 7ahi, 7bi, 7fd, 7ge, 7gk, 7hq, 7ij, 7io, 7km, 7ku, 7mf, 7qn, 7ww.

Canadian: 1ar, 1bq, 1dd, (2ax), (3ly), (3tb), 4dq, 5gf.

Cuban: DZ.

British: 2kf, 2od, 2sz.

Mexican: 1b, bx.

(Continued on Page 48)



Radio Headquarters

Why not buy your set or parts at Radio Headquarters? Only tested and approved radio equipment is sold. Every set sold by us is guaranteed to give satisfactory results.

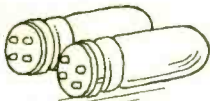

Ward's Radio Catalogue

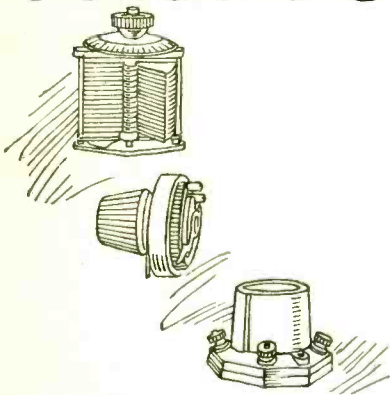

The best Radio Experts made this catalogue—men who devote their entire time to Radio—who are up to the minute with everything new, who tell you the best hook-ups, who have selected for you the best tested parts, who have chosen the best sets—so simple that you yourself can easily install them—so reliable that we guarantee them to give satisfaction.

Write for your copy of this Catalogue. See for yourself the

low prices. Buy your radio at Radio Headquarters.

Our 53 Year Old Guarantee

Ward's has dealt with the American people for 53 years under a definite guarantee of "Money back if you are not satisfied." All our Radio sets are guaranteed to give satisfactory results and back of this guarantee is a proven reliability that for 53 years has not been questioned. Address our house nearest you. Dept. 39 R.

ESTABLISHED 1872
Montgomery Ward & Co.

The Oldest Mail Order House is Today the Most Progressive

Chicago

Kansas City

St. Paul

Portland, Ore.

Oakland, Calif.

Ft. Worth

New Model Tungar charges all batteries

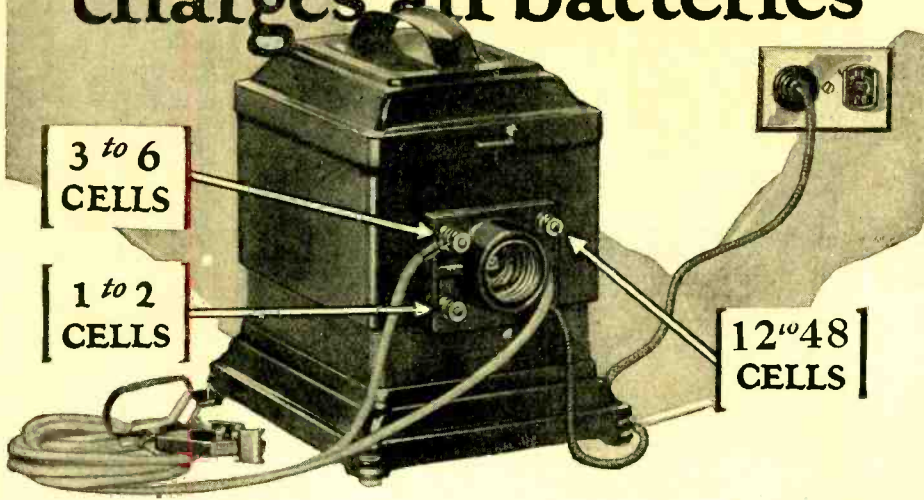

The Tungar is a G-E product, developed in the great Research Laboratories of General Electric.

The New Model Tungar charges radio A and B batteries, and auto batteries. Two ampere size (East of the Rockies) \$18.00

The Tungar is also available in five ampere size (East of the Rockies) . . . \$28.00

60 cycles—110 volts

On the back of the Tungar, there are three terminals. Slip the wire into one and charge your radio "A" battery, 2 or 4 volt size. Use the second to charge your radio "B" battery, 24 to 96 volt size. Or the third will charge a 6 volt "A" battery or 6 to 12 volt auto battery.

Just clip on the Tungar, and plug it into any electric outlet in the house or garage. Then leave it overnight to charge while you sleep. Very simple.

Tungar

REG. U.S. PAT. OFF.

BATTERY CHARGER

Tungar—a registered trademark—is found only on the genuine. Look for it on the name plate.

Merchandise Department
General Electric Company
Bridgeport, Conn.

GENERAL ELECTRIC



Build a Super-Heterodyne with the Improved "Aircore" Transformer

Points of Construction:

1. Each transformer is shielded with a NON-MAGNETIC SHIELD, which prevents interaction between the radio frequency stages and does away with using bulky shields, thus simplifying the construction of a Super-Heterodyne. A binding

post is furnished on each series for connection to Neg. A Battery.

2. Accurately matched in sets of four.
3. Moulded of genuine Bakelite.
4. Kit includes 3 matched intermediate transformers, 1 matched input transformer. Complete Blue Prints giving every detail for the making of an eight tube set. PRICE \$20.00

Jobbers and Dealers Write

THE RADIOPHONE EQUIPMENT CO.
Write for Booklet. 1409 W. York St., Philadelphia, Pa.

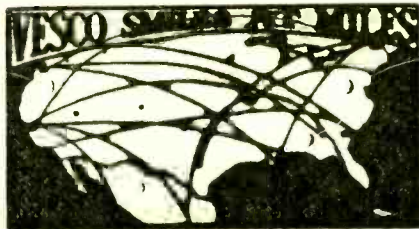

ON ONE TUBE

BIG FREE BOOKLET tells the story. California user of CROSS COUNTRY CIRCUIT hear Atlantic Coast, Canada, Cuba, Mexico and Hawaii. Atlantic Coast users hear England to California. Our new plan makes this set easiest and cheapest to build. One hour puts in operation. One tuning control. No soldering. Any Novice can do it. BIG BOOKLET FREE or complete instructions for 25c stamps or coin. VESCO RADIO CO., Box R-117, Oakland, Cal.

(Continued from Page 46)

By GCSN, 1352 Dolores Street, San Francisco, Calif., on 80 meters.
2cqz, 2da, 2dn, 3bta, 3ccx, 4io, 4ku, 4ol, 4tw, 4xe, 5aaq, 5akz, 5ame, 5are, 5atx, 5kt, 5se, 5wi, 7aab, 7adm, 7agi, 7au, 7dd, 7dl, 7dj, 7fr, 7ku, 7lj, 7mf, 7zz, 8cse, 8gz, 8nb, 9amb, 9amx, 9bcd, 9bdu, 9bdw, 9bhy, 9bjl, 9bkl, 9bmw, 9bsz, 9bvo, 9ccs, 9cdv, 9cjc, 9clq, 9ddw, 9ej, 9eky, 9mi, 9ny, 9zy.
Can.—2cq, 4hh, 5ba, 5bf, 5ef, 5an, 5go. N. Z.—4aa. WGH. KDKA. Reports on my sigs. appreciated. All crds. ansd.

By S. B. Trainer, Jr., 4 Shorncliffe Avenue, Toronto, Canada

labf, lacr, lakn, lakz, lalw, laml, lams, lana, laqz, larn, latj, laux, lavx, laxf, lbhh, lbc, lbeq, lbhg, lbiq, lbjf, lbbl, lbqb, lbqk, lbuo, lbvb, lbvl, lcau, lcde, lcsy, lcud, lcyd, lef, lez, lgv, lnc, lnt, lsf, lyd, lzo, 2aay, 2abh, 2abt, 2ad, 2adu, 2aep, 2afj, 2agi, 2agq, 2ah, 2ajp, 2amh, 2ana, 2axk, 2ban, 2bbx, 2bgf, 2bge, 2bgo, 2bjp, 2blq, 2bqu, 2bw, 2cdr, 2cgl, 2cjb, 2cor, 2era, 2cq, 2cql, 2cqp, 2crq, 2ctq, 2cv, 2ei, 2eq, 2fk, 2qx, 2ha, 2mc, 2mu, 2qh, 2wz, 2zh, 3abh, 3adb, 3aeq, 3afq, 3ajd, 3anj, 3aok, 3auk, 3ava, 3ba, 3baq, 3baw, 3bge, 3bhv, 3bhm, 3bmn, 3bf, 3bss, 3bur, 3buu, 3cb, 3cbx, 3ccw, 3cdg, 3cdn, 3cej, 3chf, 3chp, 3chr, 3ck, 3ei, 3er, 3gu, 3he, 3md, 3mk, 3mw, 3og, 3ot, 3pi, 3pp, 3qt, 3qv, 3rw, 3ud, 3uz, 3wb, 3zd, 4au, 4aw, 4bq, 4cu, 4dv, 4fs, 4gw, 4io, 4ke, 4mb, 4my, 4nt, 4on, 4ov, 4pd, 4pk, 4sh, 4sl, 4uk, 4um, 5abc, 5ag, 5agi, 5au, 5ajn, 5ajp, 5ak, 5akp, 5akx, 5ame, 5amh, 5amw, 5api, 5bj, 5ew, 5fs, 5jf, 5ka, 5kk, 5lu, 5qk, 5ru, 5tg, 5xa, 5za, 6age, (6tl), (6bch), 6chx, 7dd, (7gs), 7vh. Eights too numerous. 9aan, 9aaq, 9aci, 9adk, 9ado, 9adx, 9aem, 9aex, 9ago, 9ahu, 9aif, 9aim, 9alo, 9akn, 9all, 9alu, 9amp, 9aoo, 9aor, 9ato, 9atu, 9avb, 9avw, 9awg, 9awu, 9azl, 9bay, 9bcy, 9bdr, 9beg, 9beh, 9bew, (9bfg), 9bfu, 9bhb, 9bht, 9bib, 9blr, 9bkr, 9bmc, 9bmd, 9bmk, 9bmx, 9bnt, 9bni, 9bnk, 9bov, 9bpn, 9bpy, 9bqj, 9brn, 9bsp, 9btz, 9buk, 9bwb, 9bww, 9byf, 9bzf, 9caj, 9cbv, 9ccy, 9cdw, 9ce, 9cec, 9cfl, 9cfx, 9cga, 9cho, 9chx, 9cjc, 9ckh, 9ckj, 9ckl, 9cld, 9cmp, 9cmr, 9cof, 9cov, 9cow, 9cpm, 9cte, 9cun, 9cuu, 9cwk, 9cxs, 9cxx, 9czl, 9dac, 9dat, 9dau, 9day, 9dbj, 9dbp, 9del, 9del, 9dix, 9dja, 9dij, 9djm, 9dkc, 9dkt, 9din, 9dma, 9dmh, 9dmy, 9dnn, 9dqu, 9dpc, 9dpu, 9dro, 9drs, 9dtt, 9dui, 9dur, 9dvc, 9dvw, (9dwh), 9dww, 9dxa, 9dy, 9dyc, 9dzg, 9eal, 9eas, 9ebj, (9ebu), 9eci, 9efz, 9egi, 9ehq, 9eib, 9ejm, 9ekh, 9eky, 9elr, 9em, 9ep, 9er, 9gc, 9gp, 9jg, 9lb, 9mn, 9my, 9ni, 9pb, 9pd, 9ti, 9tv, 9tw, 9yau, 9yb, 9zt.

By John H. P. Andrews, Lake and Bellona Avenues, Baltimore, Md.

6afg, 6ame, 6bgo, 6bkb, 6blh, 6bnt, 6bqr, 6crs, 6css, 6czx, 6eb, 6mm, 6ts.
English: 2jf, 2kz, 2nm, 2od, 2sh, 2sz, 5lf, 6nf.
French: 8ap, 8go, 8sm, 8su.

By GAI.V. Alameda, Calif.

1ar, 1aac, 1ary, 1abt, 1ajq, 1bdh, 1dbx, 1bie, 1bsd, 1cmp, 1fd, 1kc, 1ml, 1sf, (1ow), 1xam, 1xz, 2ag, 2by, (2bqc), (2brb), 2cpk, 2cqz, 2cvj, 2cvu, 2eq, 2rk, 2wr, 2yb, 2xay, 3ab, 3adp, 3ade, 3bng, 3bva, 3cc, (3cdv), 3chg, 3hh, 3hg, 3hj, (3qt), 3wg, 4do, 4io, 4kl, 4my, 4tj, 4gw, 4xe, 5ac, 5aaq, 5aex, 5afu, 5aku, 5alr, 5ajb, 5ajf, 5ajj, (5nw), 5se, 5uo, (5gk), 5cv, (5uk), 5ka, 5za, 5zav, too many 6's and 7's—8aa, 8ah, 8ada, (8amr), (8bau), (8bnh), 8cyl, 8dal, 8dau, 8fz, (8pl), 8ry, 9's too many. NKF, NFV, WGH.

English: g5nf, g2nm.
Holland: ZERO—LL.
Porto Rican: (4sa).
Cuban: 2mk.
French: UFT.
German: POZ.
Australian: 3bd, 3bq, 2cm, 2yg.
New Zealand: 4aa, 4ak, (2ac), 4ag, 2xi?
Canadian: (2be), 4cr, 4io, 5gf.
Mexican: BX, JB or IB.
All on low waves. Transmitter 90 watts input. QRK?

By Jack Contant, SAKK, 42 Akron St., Rochester, N. Y.

1acr, 1adl, 1aeu, 1agg, 1agr, 1ahz, 1all, 1ana, 1ams, 1apf, 1apx, 1aql, 1aqz, 1avl, 1awe, 1axn, 1ayd, 1bav, 1bbk, 1bet, 1bvr, 1bub, 1ckk, 1cav, 1cxm, 1ve, 1gm, 1zn, 2acp, 2acs, 2ads, 2adu, 2ais, 2bdg, 2bqb, 2bqc, 2buo, 2byq, 2cpa, 2cqp, 2crb, 2ctn, 2wj, 2cj, 2gx, 2iu, 2kk, 2rb, 3bnj, 3ckk, 3cdu, 3fn, 3fu, 3oh, 3hd, 3ol, 3ub, 3uz, 3zo, 4eg, 4fl, 4ly, 4ml, 4sl, 4tw, 4tj, 4un, 4xe, 5afn, 5aui, 5ask, 5ak, 5kc, 5k, 5ox, 5se, 7sy, 7zu, 8ags, 8agw, 8arr, 8awa, 8awe, 8axf, 8bbg, 8bik, 8bin, 8bgw, 8bja, 8bjt, 8ble, 8bn, 8bnj, 8bmv, 8boy, 8brb, 8bxt, 8cby, 8ck, 8cko, 8cv, 8daa, 8dbt, 8dfo, 8dja, 8dme, 8dmx, 8dok, 8dpo, 8aaq, 8aau, 8aef, 8afo, 8afa, 8aib, 8ajk, 8akb, 8akk, 8aok, 8avb, 8bbe, 8bcc, 8bcd, 8bft, 8bio, 8bky, 8bmc, 8bmn, 8bpy, 8bre, 8bvw, 8cap, 8cas, 8cbl, 8cme, 8cgr, 8ctx, 8dgy, 8dhl, 8diq, 8dmc, 8dpu, 8drs, 8dsh, 8ez, 8tw.

(Continued on Page 50)

8 improvements
at ONE stroke

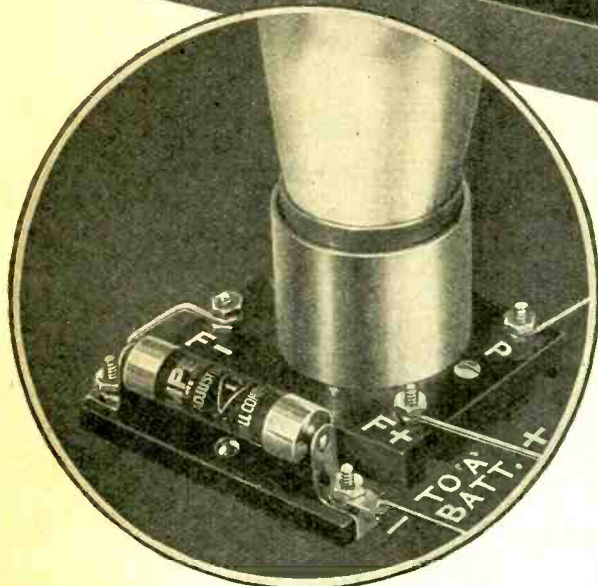
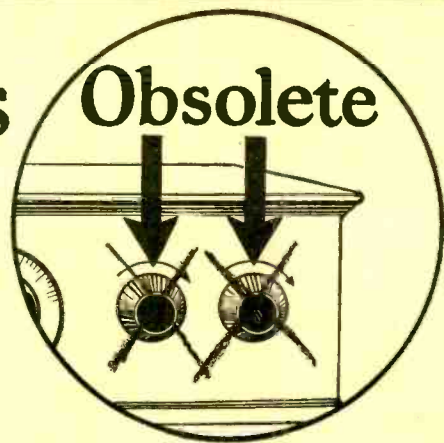

The Self-Adjusting Rheostat

1. Eliminates hand rheostats—thereby simplifying control and giving compactness.
2. Greatly simplifies set wiring, therefore making for greater efficiency.
3. Prolongs life of tubes from 2 to 3 times.
4. No moving parts—therefore no grinding noises.
5. Permits use of any type of tubes or any combination of tubes.
6. No filament meters necessary.
7. Brings the most out of each individual tube — automatically — no guessing.
8. Makes perfect tube operation absolutely fool-proof.

AMPERITE operates on the thermoelectric principle. Contains a specially treated filament hermetically sealed in a glass tube and surrounded by an inert gas. This filament has the unique property of automatically changing in resistance as the "A" battery voltage changes—so that a practically constant current is maintained in the tube filament. Consequently the tubes are constantly operated at maximum efficiency. No knob to turn. Nothing to get out of order. Amperite mounts conveniently inside the set. Really takes the place of a good hand rheostat, a delicate meter and an expert operator. Thoroughly approved by every prominent laboratory. Used as standard equipment in such sets as Somerset, Ultradyne, Marshall, Pfanstiehl, Kilbourne & Clark, Heteroplex, Cockaday and numerous others. Perfect for every circuit. Fully guaranteed.

PRICE \$1.10 EVERYWHERE

Write for
FREE
Hook-Ups

RADIALL COMPANY

Dept. R-8, 50 Franklin St., New York

AMPERITE

REG. U.S. PAT. OFF.

"means right amperes"

HEATH RADIANT

Non-Dielectric Condensers

Contributing to the Popularity of

Grounded Metal
End Plates

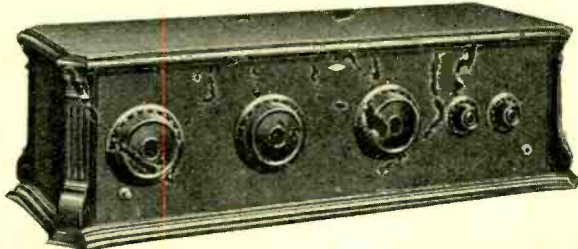

The SPLITDORF Receiver

HEATH CONDENSERS play an important part in the accuracy, easy tuning and range of this remarkable Splitdorf Receiver. The choice by such an eminent manufacturer of Heath Condensers is convincing evidence of thorough-going quality of both materials and workmanship and also of superior design. This sort of evidence is your best guide in the choice of condensers.

PRICES FOR VERNIER CONDENSERS

		With Dial	Without Dial
No. 12AV	12 Plate.....	\$5.00	\$4.35
No. 24AV	24 Plate.....	5.50	4.85
No. 44AV	44 Plate.....	6.50	5.85

Non-Vernier types in all capacities.

Heath Sockets with the Exclusive Shock Absorber Feature. Price 75c.

Heath Genuine Bakelite Dials in 2, 3, 4-in. sizes. See the Heath Condenser at your dealer's.

Write for Literature



HEATH RADIO & ELECTRIC MFG. CO.

208 First Street
Newark, N. J.

Pacific Radio Distributors:
FREDERIC L. THOMLINSON CO.

443 Pacific Bldg., San Francisco, California.

Canadian Distributors: Marconi Wireless Telegraph Co. of Canada, Ltd., Montreal, St. Johns, Vancouver, Winnipeg, Halifax and Toronto.

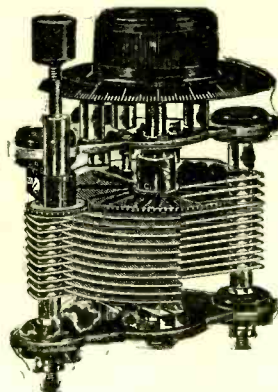

Permanently Flat
Plates

Stamped under huge presses to absolute flatness, tempered to prevent warping.

Micrometer Geared
Vernier

Ordinary adjustments reduced by separate geared adjustment to hair-breadth distinction. We guarantee the Heath Vernier Condenser to be more highly selective than any condenser employing a vernier which actuates ALL of the plates.

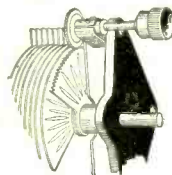

(Continued from Page 48)

By 3CHG, 412 Meredith St., Kennett Square, Pa.

6av, (6bm), 6bt, 6cw, 6eb, 6ew, (6fy), 6gg, (6gt), (6gx), 6hc, 6ji, (6of), 6oi, 6pl, (6rn), (6ts), (6vc), (6vo), (6vw), 6xad, 6ze, 6zh, (6zp), 6zah, 6aao, (6adt), (6afg), (6age), (6agk), (6ahp), (6aib), 6akw, (6alk), 6alv, 6ame, (6amm), (6amo), 6aot, 6apw, (6aqd), (6arb), (6arb), 6ase, 6avr, 6awt, 6bau, (6bbv), (6bc), (6bdt), 6beb, 6bez, (6bjj), 6bjx, (6blw), (6bny), 6bql, 6bqr, 6bsc, (6bur), 6cae, 6cen, 6cct, (6ccy), (6cgk), 6cgo, (6cgw), (6chg), 6cix, 6cmu, (6cnl), (6crx), 6css, (6cto), 6czx, (7fd), (7fq), (7gb), 7gf, (7gm), 7ho, 7ij, 7ku, (7lq), 7mf, 7mp, (7qd), 7sf, 7sp, (7to), 7wm, (7abb), 7ahi, (7afo).
Australia: (3bq), 2cm.
Belgium: (P2).
Bermuda: BER.
Canadian: (5bz), (5go).
Cuba: (2mk).
Dutch: OBA.
English: (2dx), (2jf), (2kf), 2kw, (2kz), (2nm), 2od, 2sh, 2sz, 5ma, 5nn, 5rz, 6nf.
French: (8ab), (8ago).
Mexico (1b), bx.
Porto Rico (4je), (4sa).
South America: DB2.
New Zealand: (4aa), (4ag), 4ak, (2ac), (2ap), 2xa.

5AQW, 223 So. 3rd St., Enid, Okla.
Canadian: 1dd, 1dq, 1ef, 1ei, 2ax, 2be, 2bq, 2fo, 2cg, 3aa, 3ad, 3di, 3jb, 3kq, 3ly, 3nf, 3ni, 3mg, 3aec, 3zb, 3zt, 4eo, 4cr, 4fz, 4dq, 5as, 5ba, 5go, 5cn, 9bb.
New Zealand: 2ac, 4aa, 4ag.
Australian: 3bq.
French: 8sm.
English: 1kr, 2kf, 5uq.
Netherlands: EAR-2, OAL.
South American: 9tc, LPZ. Heard 1-X, using code on intermediate "DEUN" gra? A card goes out before we tack yours up, qrl es c.

By F. O. Chilton, Wahnooga, Sydney, Australia

U.S.: 1emp, 1pl, 1ow, 1xam, 1xav, 2adq, 2brb, 2bsc, 2rk, 2xq, 3cf, 3chg, 4io, 4oa, 4tj, 5go, 5in, 5mi, 5nw, 5qy, 5rh, 5uk, 5zai, 6chl, 6ahp, 6akw, 6ao, 6arb, 6awt, 6bbv, 6bdt, 6bon, 6bpu, 6cgo, 6cgw, 6chl, 6dgp, 6dkm, 6do, 6rn, 6zp, 7pm, 7ij, 8atr, 8bcj, 8bht, 8ckt, 8clq, 8dq, 8efz, 8ei, 8eky, 8pl, 9xav, 9xi, also NKF (c.w.) and KGO.
Communications from any of the above would be appreciated.

By 9APY, 3337 Oak Park Ave., Berwyn, Ill.

1abf, 1ajx, 1aiw, (1amf), 1apf, 1aw, 1bdx, 1biq, 1bom, 1hj, 1ml, (1or), 1pp, 2aan, (2agm), 2agw, (2al), 2apv, 2bbn, 2bbx, 2be, 2bfe, 2bmq, 2buy, 2cgb, (2cnk), 2cwj, (2cwt), 2cxg, 2fc, 2ha, 2kf, 2mc, (2zb), 3abw, 3ach, 3ajp, 3auv, 3awu, 3bei, 3bfq, 3bu, 3cdg, 3cgc, (3cgs), 3chc, 3kl, 3nf, 3nw, 3ol, 3pp, 3wf, 3xx, 3zg, 4af, 4db, 4eq, 4fa, 4io, 4iz, 4jr, 4si, 4uk, 5aaq, (5adw), (5aek), (5akp), 5aqf, 5arb, 5atf, 5atx, 5ls, 5ot, 5qh, 5ux, 6arb, 6bka.
Canadians: C-2DN, (C-4AE).
Phones: 3xan, 5apz, 5qd, 8ais, 8brc.
A card awaits every QSL.

By 2ACS, 331 Germania Ave., Schenectady, N. Y.

5ap, 5ca, (5ck), 5li, 5hw, 5hy 5ik, 5in, 5ka, 5lh, (5ls), 5lu, 5nw, 5ov, 5pa, 5qh, 5qp, 5qy, 5se, (5sd), 5uk, (5wi), 5wy, (5aa), 5aaz, 5ac, (5ado), 5adz, 5aeq, 5aex, 5agl, 5ago, (5agv), 5ahd, 5ahj, 5aiu, 5aiy, (5ajn), (5ajt), 5ajv, (5akn), 5air, 5alz, 5amg, (5apy), 5aqw, (5as), 5asr, 5xai, 5xat, 6ac, 6ea, 6eb, 6ew, 6fy, 6lv, 6of, 6pl, 6rn, 6ti, 6ts, 6uw, 6ux, 6vc, 6xi, 6zh, 6acu, 6afg, 6age, 6ahp, 6aiu, 6aiv, 6akw, 6alw, 6ame, 6amf, 6amm, 6amo, 6ase, 6awt, 6bau, 6bbv, 6bdt, 6bez, 6bgc, 6bip, 6bin, 6bjj, 6bka, 6bnf, 6bqb, 6bql, 6bqr, (6cct), 6ccy, 6cdn, 6cgw, 6chl, 6cix, 6cjl, 6civ, 6ckf, 6cmg, 6cmi, 6cml, 6cnl, 6cqe, 6crs, 6cso, 6css, 6csw, 6cto, 6czo, 6czx, (6xad), 6xby, 7au, 7bj, 7co, 7dd, (7dj), 7id, 7ig, (7gb), 7gl, 7gk, 7gr, 7jr, 7ku, 7kz, 7mf, (7mp), 7no, 7ok, 7oy, 7rk, 7sf, 7to, 7uk, 7wm, 7zq, 7zz, 8abb, 7aeh, 7afn, 7afo, 7ahv, 7ajv, (7ajy), 7akk.
England: (2jf), 2kf, 2kz, 2iz, 2nm, 2od, 2sh, 2sz, 5lf, 5mq, 5qp.
France: 8ap, 8go, 8sm.
Holland: (OBA), OLL, ONL, PCII.
New Zealand: 4ag.
Miscellaneous: BX, BER, (PAX), QRA?
Canada: (4dq), (4fv), (4fz), (4io), 5ak, 5an, (5ba), 5ef, (5gf).
Have you heard me? Please QSL.

By 5NW, Wayland Groves, Denton, Texas
Canadian: 1ar, 1dd, (2ax), (2be), (2ct), (3aa), (3ad), (3aec), (3ly), (3zb), (4io), 5ak, 5ba, 5bz, 5go, 9al.
Mexican: (BX), (1B), 1K.
New Zealand: (2AC), 2AP, 4AG, 4AK.
Australian: (2ds), (3bq), (NKF), BER.
QRK? My 5 watter.

(Continued on Page 88)

DX "mushy"?

FREE BOOKLET

On "Tube Control" tells how to bring in distant stations clear and loud. Just drop a post card to

UNITY MFG. CO.
224 North Halsted St.
Dept. R, Chicago, U. S. A.

SAVE 20%

From List Price ON ALL STANDARD RADIO MERCHANDISE

NO EXCEPTION Every type and manufacture from ATWATER-KENT to WESTERN ELECTRIC

IMMEDIATE DELIVERY

10% Deposit with order

ECONOMY RADIO SALES CO.
P. O. Box 99, Station O, Dept. 30,
New York, N. Y.

Reprints of Best's New Super-25c. "RADIO" S. F., Cal.

Bakelite — Faultless servant of Radio's invisible audience

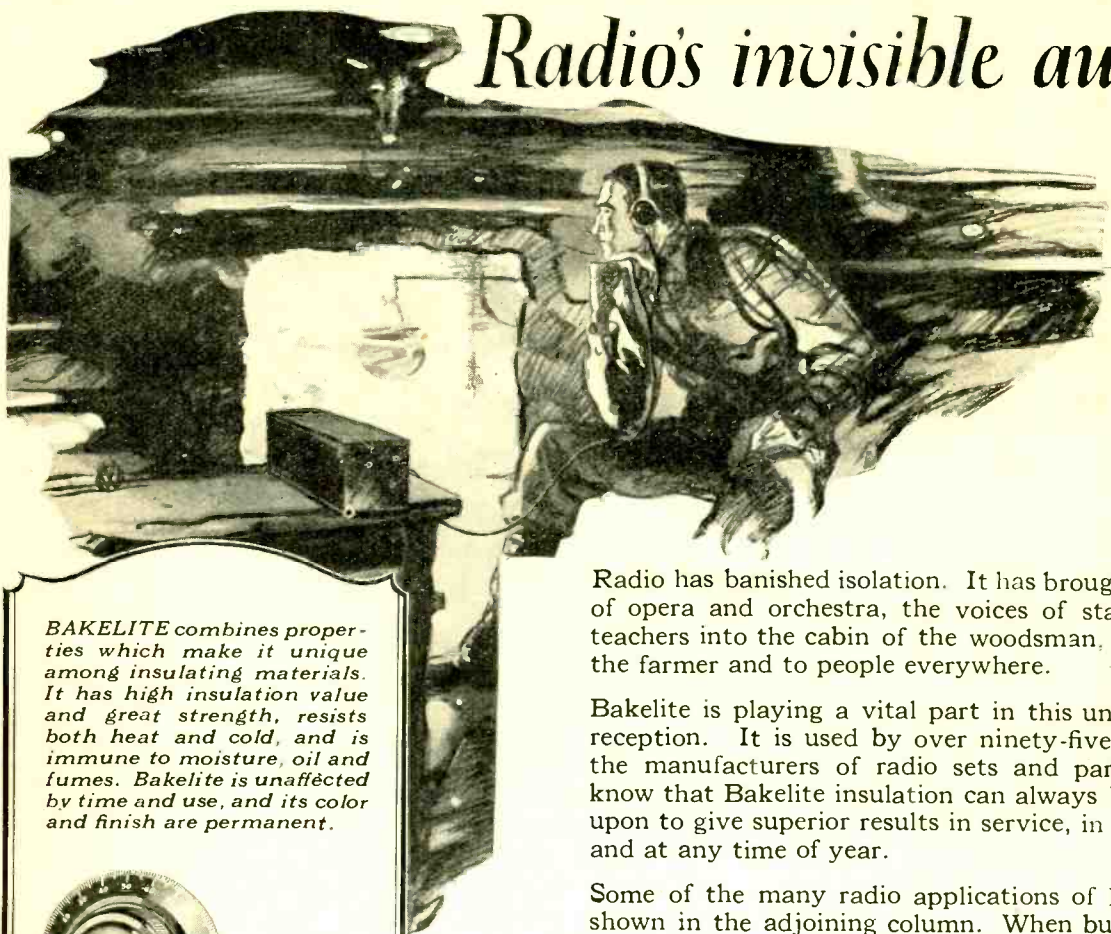

BAKELITE combines properties which make it unique among insulating materials. It has high insulation value and great strength, resists both heat and cold, and is immune to moisture, oil and fumes. Bakelite is unaffected by time and use, and its color and finish are permanent.



Na-ald Dial



Rathbun Condenser



Na-ald Tube Socket



R. C. A. Tube Base

Radio has banished isolation. It has brought the music of opera and orchestra, the voices of statesmen and teachers into the cabin of the woodsman, the home of the farmer and to people everywhere.

Bakelite is playing a vital part in this universal radio reception. It is used by over ninety-five per cent of the manufacturers of radio sets and parts, for they know that Bakelite insulation can always be depended upon to give superior results in service, in any climate and at any time of year.

Some of the many radio applications of Bakelite are shown in the adjoining column. When buying a radio set or part make sure it is Bakelite insulated, for this is a definite indication of quality.

Write for Booklet S

BAKELITE CORPORATION

247 Park Avenue, New York, N. Y.
Chicago Office: 636 West 22d Street

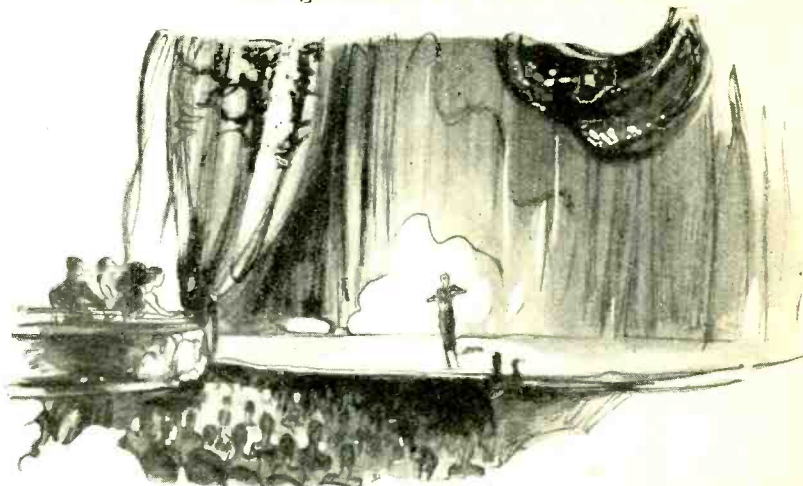

Bakelite is an exclusive trade mark and can be used only on products made from materials manufactured by the Bakelite Corporation. It is the only material which may bear this famous mark of excellence.

BAKELITE

TRADE MARK REG. U. S. PAT. OFF.

BAKELITE is the registered trade mark for the phenol resin product manufactured under patents owned by the Bakelite Corporation

THE MATERIAL OF A THOUSAND USES

3527-B

Tell them that you saw it in RADIO

RADIO ON THE C. N. R.

(Continued from Page 14)

pet. The studio walls are properly sound-proof, with 4 in. of hollow tile, plastering and finish. The ceiling is treated with moveable panels and draped with light blue rep to match the general effect. It offers a very pleasing aspect and has proved to be admirably adapted to the acoustic requirements.

The installation consists of a 500-watt antenna output transmitter with power panel, speech input equipment and the necessary radio receiver. The motor generator set is placed in the smaller of the two rooms on the roof, enabling the operating room to be used solely for control and other panels. The studio and operating room are properly connected by interphone and signal system. In addition, room control wires from various points of assembly in the city of Ottawa are brought direct to the terminal board of the operating room, and provision has been made for long-distance telephone lines for tying-in with other broadcasting stations in different cities. Numerous telephonic connections have also been established for microphone and telephone control from points in the Chateau Laurier, the company's hotel in Ottawa, and other places, from which it is intended to radiocast addresses direct from this operating room.

As another example of a radiocast station CNRA, at Moncton, New Brunswick, may be quoted. This station is broadly modelled upon the lines of the mother radio station at Ottawa, but incorporating all the improvements and refinements which experience with the Ottawa installation revealed as contributing to higher efficiency and more perfect and greater radiation. Certainly it is one of the most powerful and best equipped stations in the whole of the Dominion. The aerial is supported upon two steel towers, each 150 ft. in height, and spaced 200 ft. apart. They are of the quadrilateral type, colloquially known as the "Eiffel Tower" from their resemblance to the famous landmark of steel forming such an important radio station in the capital of France. At the base the legs are spaced 34 ft. apart, and taper to about 3 ft. apart at the top. Each leg is bolted to a solid block of concrete, measuring 5 ft. each way and buried to a depth of 5 ft. in the ground. This monolith of 25 cu. ft. weighs 15,500 pounds, and as there are four of these massive blocks to each tower the complete anchorage for the steel fabric, to assure the necessary degree of stability, scales 31 tons.

The towers are set upon the lawn at Moncton railway station between the tracks and the general office building. They are so disposed as to come upon a line roughly drawn from Sydney, Nova Scotia, through Moncton, to Montreal.

The operating room, in which the

(Continued on Page 54)

"In September you advertised a one mfd. By-Pass Condenser to be attached across the 'B' battery. As I had three sets of 'B' batteries (detector, amplifier, and power amplifier), I purchased and installed three of them. They 'did the work' magnificently."



"They did the work!"

This message came from one pleased radio fan—from just one radio fan—but the experience of many others is identical.

And you, too, will find that a Dubilier By-Pass Condenser in your set will eliminate noises—purify reception—and do the work magnificently!

Dubilier

CONDENSER AND RADIO CORPORATION

FILE-KO-LEAK

SCIENTIFICALLY CORRECT
VARIABLE GRID LEAK

HAND CALIBRATED IN MEGOHMS—Eliminates distortion; increases volume. Can be read through panel peep-hole and logged. Ask your dealer or write Dept. R325, DX INSTRUMENT COMPANY, Harrisburg, Pa.

25c

BEST'S NEW
SUPER-HET
REPRINTS
"RADIO"

San Francisco, Calif.

RADIOCAST WEEKLY

48 Pages of
Programs, Photos, Humor
Musical Reviews, Schedules,
Tables, Editorials, Etc.

5c Per Copy Radiocast Weekly
433 Pacific Bldg.,
SAN FRANCISCO

(Continued from Page 52)

whole of the electrical apparatus is housed, is upon the third floor of the general offices; while the studio is placed in a suitable building in the town within easy reach of the transmitting station. This arrangement has been adopted for convenience and to ensure the requisite freedom from disturbance by extraneous noises capable of detracting from clear transmission. The control, therefore, is of the remote type.

The main radiation is given from the western end of the aerial for the reason that it points towards the greatest receiving zone extending through the New England States, and the populous territories distributed along the St. Lawrence River and the Atlantic seaboard. Although a certain measure of directional transmission is thus forthcoming it is not to the detriment of clear, long-range transmission to other points of the compass as radio enthusiasts throughout the three Maritime Provinces from Halifax to the Gaspé Peninsula, Glace Bay to St. John, and from Yarmouth to Prince Edward Island have been able to testify. Even residents from Anticosti Island, along the Labrador shore and in Newfoundland have been able to pick up the Moncton signals. Another point of particular satisfaction to the Department is that Moncton has proven itself capable of being picked up far out at sea and has bridged the Atlantic ocean to be heard in various parts of the British Isles.

One other feat in which Calgary shared honors with Moncton was an inter-station communication between these two points, each being received at the other city, an air line distance of approximately 2,200 miles. In the development of the radio program of the system there was another important feature to be considered. At the beginning all of the various stations used different call letters, none of which had any relationship to the railway. It was desired to use the call letters CNR because these are the initial letters of the words that go to make up the name of the Canadian National Railways, but it was soon discovered that the call letters CNR had been allotted to the Government of Morocco. It was decided to ask Morocco to relinquish these call letters. That required continued and delicate diplomatic action and through the happy co-operation of the Federal Government of the Dominion of Canada, the British Foreign Office and the French Government this proved successful and permission was granted for the Canadian National Railways to use the initials CNR. To these letters were added another indicative of the place of broadcast. For instance Montreal has CNRM, Ottawa, CNRO; Toronto, CNRT; Calgary, CNRC; Winnipeg, CNRW; Edmonton, CNRE; Regina, CNRR;

(Continued on Page 56)

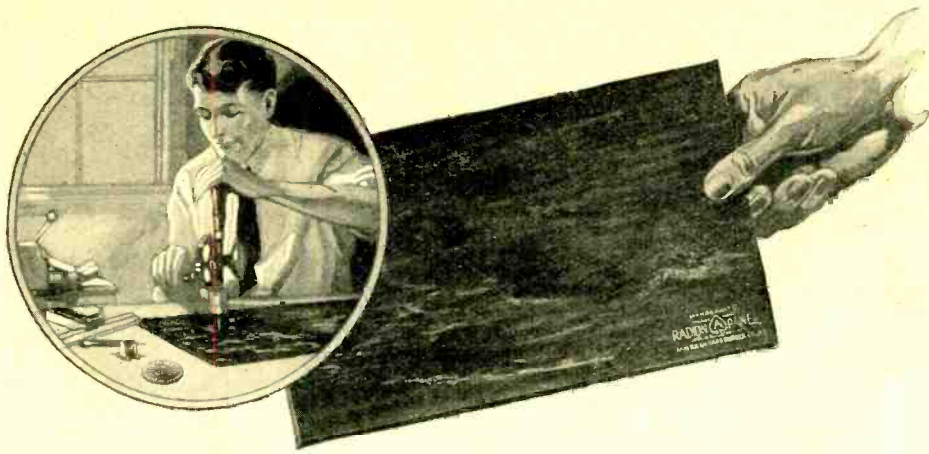

Just use ordinary tools on this panel —built to order for radio

YOU don't need special tools to do a good job on a Radion Panel. Just the usual tools found around any house will give you clean-cut, workmanlike results. You need not have the slightest fear of chipping.

Radion is the easiest of all to cut, drill, and saw. It was developed to order by our engineers to meet the demands of radio set builders. There is nothing quite like it for real results.

Highest rating as radio-frequency insulation

Authoritative laboratory tests give Radion the highest rating as radio-frequency insulation. That means that losses from surface leakage and dielectric absorption are exceptionally low. And low losses means clearer reception, more volume and more distance.

Other Radion Products

The same qualities of low-loss insulation and attractive appearance characterize Radion dials (to match panel), binding post panels, insulators, knobs, etc.—also new Radion built-in horn.

You can see that Radion is different by looking at the finish. But that high-polished, satin-like surface is not for beauty alone. It's useful, too. Moisture and dirt cannot gather to cause leakage and leakage noises.

Radion resists warping. It's strong. It's moisture proof. It comes in eighteen stock sizes and two kinds, Black and Mahogany.

Better performance will make it worth your while to ask for Radion by name, and to look for the name on the envelope and the stamp on the panel. Radio dealers have the exact size you want for your set.

Send for booklet "Building Your Own Set"

Our new booklet, "Building Your Own Set," giving wiring diagrams, front and rear views, showing a new set with slanting panel, sets with the new Radion built-in horn, lists of parts and directions for building the most popular circuits, mailed for ten cents. Mail coupon today.

AMERICAN HARD RUBBER COMPANY
Dept. M-3, 11 Mercer Street New York City
Chicago Office: Conway Building
Pacific Coast Agent: Goodyear Rubber Co., San Francisco—Portland

RADION

The Supreme Insulation
PANELS

Dials, Sockets, Binding Post Panels, etc.

American Hard Rubber Company,
Dept. M-3, 11 Mercer St.,
New York City

Please send me your new booklet,
"Building Your Own Set," for which
I enclose 10 cents (stamps or coin).

Name.....
Address.....
City..... State.....

RADIO INSTITUTE OF AMERICA

TRAINING IN ALL COMMERCIAL BRANCHES OF RADIO

If you cannot attend the Radio Institute of America in person the same instruction can come to you through our recently inaugurated "HOME STUDY COURSE"—Investigate.



Detailed information free on request.

Conducted by

THE RADIO CORPORATION OF AMERICA

28 Geary St.

Phone Garfield 4200

San Francisco, Calif.

98 Worth St.

Phone Franklin 1144

New York City



FREE SUPER KIT

For 6 Subscriptions to "Radio"

The Baldwin-Pacific QUINTET KIT is the feature premium offer this month for securing subscriptions to "RADIO." The kit will be given to you without one cent of cost by merely sending us six subscriptions for one year each at \$2.50 per year, or three subscriptions for two years each. The total amount of subscription money required to get one of these kits is only \$15.00. You send us \$15.00 worth of subscriptions and get a \$15.00 kit without cost. This offer is made for the sole purpose of increasing our paid subscription list.

The Baldwin-Pacific Quintet Kit is a well known, nationally used product. It contains the necessary parts for constructing the 45,000 cycle receiver. 1 Oscillator Coupler, 3 Pacific Intermediate Frequency Transformers and 1 Pacific Filter Transformer make up the kit. The publishers of "RADIO" guarantee this premium offer to be exactly as represented. Your money cheerfully refunded without question if you are not satisfied with your premium. Get three of your friends to subscribe for two years to "RADIO" or six for one year—and the kit is yours. Shipments made 24 hours after your order reaches us.

A \$30.00 value for \$15.00. Only a very limited number of these kits will be awarded. Get yours right now!

"RADIO,"
Pacific Building,
San Francisco, Calif.

Here is \$15.00. I am attaching the names and addresses of 6 subscribers to "RADIO" for 1 year each. Immediately send me one Baldwin-Pacific Kit, postpaid.

Name

Address

This offer good only until April 15. We urge you to act quickly if you want this wonderful premium free of cost!

(Continued from Page 54)

Saskatoon, CNRS. Difficulty arose in the case of Moncton where, had the same plan been carried out, the call letters would have clashed with those of Montreal. It was decided, therefore, to name Moncton station, CNRA, the "A" symbolizing the Atlantic region of the Canadian National Railways of which Moncton is the headquarters.

Briefly, this is the history of the establishment of the radio service of the Canadian National Railways. But the building of stations and the equipping of trains with receiving sets was only one feature of the work. There had to be a directing policy if the service was not to prove a hit and miss affair. It had to be, moreover, a policy of real service not merely to the company and its patrons, but to the country at large, if it was to justify itself and to retain its popularity. That policy, as it was conceived and as it has been followed, is a policy of service.

Music and features of entertainment are only part of the policy of the company. The real policy lies in the dissemination of information about Canada that is calculated to attract the attention of capital of settlers and of tourists. Every program has on it a short address written with this end in view. Information on the natural resources, the physical attractiveness, the opportunities to the settlers, the capitalist and the industrialist of Canada have been sent from every radio station of the Canadian National Railways. How wide-flung has been this publicity may be judged from the fact that during the year more than 50,000 applause cards have been received from every part of Canada and the United States and letters telling of the reception of these stations have been received from Great Britain, New Zealand and Honolulu. Officers of the radio department conservatively estimate the nightly audience at more than four million people and the traffic and colonization departments attest to the efficiency of radio in requests for further information as to holiday resorts and to the opportunities offered the young men on the land in Canada. Passengers on trains have not hesitated to express their appreciation of the entertainment provided them en route across the country.

Another important plank in that policy is the co-operation of the radio department with the national welfare campaigns. The value of this co-operation was splendidly illustrated during "Forest Fire Prevention Week," when the need of protecting Canada's forests from destruction by fire were sent from every station then in operation. In this work men high in the public life of the Dominion, Cabinet Ministers, Premiers of Provinces, Directors of Forest Service for the Government and leaders in the

(Continued on Page 58)

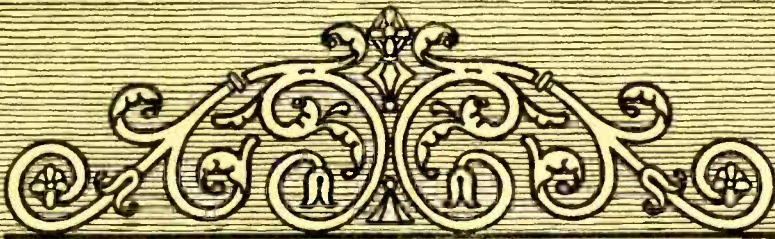

MEMBER
RMA

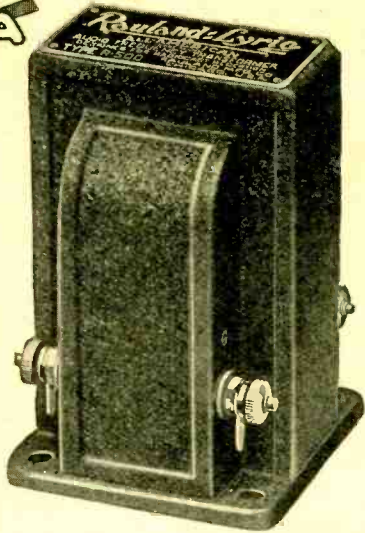

Radio Music for the Critical

Music lovers find an especial delight in Rauland-Lyric. Used in all audio stages of a radio receiver, it reproduces with fidelity those elusive refinements of tone quality which, to the trained ear, mean artistic excellence.

Rauland-Lyric is a laboratory-grade audio transformer designed especially for music lovers. The price is nine dollars. Descriptive circular with amplification curve will be mailed on request. All-American Radio Corporation, 2654 Coyne Street, Chicago.

Rauland-Lyric
AN

ALL-AMERICAN
TRADE MARK
TRANSFORMER

The Choice of Noted Music Critics



Thompson Tone--

a quality of naturalness never before attained in radio reception

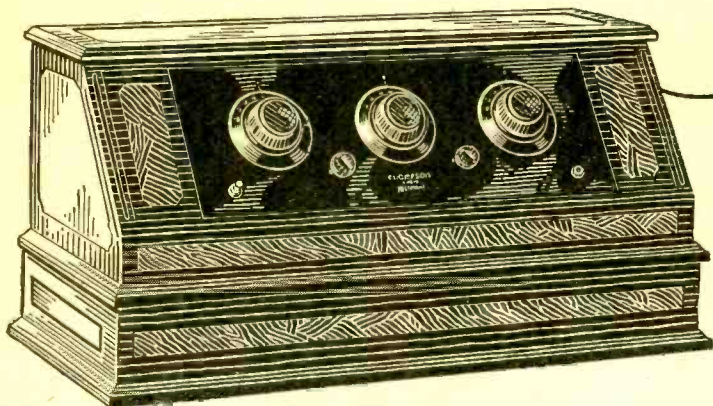

THE THOMPSON CONCERT GRAND The Only 6-Tube Neutrodyne

IMAGINE a Radio Receiver so capable as to fill a Concert Hall seating 1,500 people, and the quality of tone so natural as to carry no suggestion of mechanical or electrical reproduction!

The Thompson Concert Grand (Model S-70) is seldom used at full power; yet when the occasion requires, it will fill a Ball Room, Concert Hall, or other large gathering place, with speech or music, and at no sacrifice of tonal quality. In fact it provides a quality of tone never before attained in radio reception.

The reason for the remarkable performance is due to the use of exclusive Thompson audio transformers. Three stages of audio amplification without

distortion is a distinct achievement in radio engineering.

Eminent radio authorities have acknowledged the Concert Grand Model as the latest and most important achievement in the development of Home Radio Receiving sets.

The beautiful two-tone mahogany finished cabinet, with sloping panel and special compartment for all dry batteries is an outstanding example of the cabinet maker's art. Equipped for either dry or storage battery operation. The Thompson Concert Grand (Model S-70) is \$180 without accessories.

For fifteen years the Armies, Navies and big Commercial Companies of the world have used radio apparatus produced by the Thompson Organization. This experience pre-eminently places it in position to supply the best for Home Radio Purposes.



A creation that reaches the highest pinnacle of TONE REPRODUCTION
the

THOMPSON SPEAKER

THE Thompson Speaker was designed by famous engineers with wide experience in acoustics and sound reproduction.

It has the most natural tone of any speaker on the market today—and a greater capacity for volume.

An efficient speaker is necessary in combination with a radio receiving set to secure desirable results. Any good receiving set is limited if a first-class speaker is not used.

Many people, unfortunately, not realizing the importance of owning a first-class radio speaker, are sacrificing the richness and sweetness of tone through the use of an inferior speaker, whose only appeal rests in its low price.

The Thompson Speaker has seven unusual features which combine to make tone reproduction beautifully satisfying in its Trueness and Fidelity to every musical pitch and tone.

The Thompson Speaker is the only speaker—within its price range—that can function efficiently on sets using five or more tubes.

Regardless of price or type, a Thompson Speaker will improve the tonal reproduction of your receiving set.

NOW ONLY \$28
West of Rocky Mountains \$30

THOMPSON RADIO NEUTRODYNE



VARIOUS MODELS
\$125 to \$180

WEST OF ROCKY MTS.
\$130 to \$185

Embodying Exclusive and
Important Features

On request, an interesting booklet will be forwarded

R. E. THOMPSON MANUFACTURING COMPANY
30 CHURCH STREET, NEW YORK, N. Y.

Now you can UNDERSTAND RADIO!

Take the mystery out of it—build and repair sets—explain the vacuum tube—operate a transmitter—be a radio expert!



**1 VOLUME
514 PAGES**
Leatheroid Edition

Compiled by
HARRY F. DART
E.E.

Formerly with the
Western Electric
Co., and U. S.
Army Instructor
of Radio.

Technically Edited by **F. H. Doane**
100,000 ALREADY SOLD

This practical and authoritative I. C. S. Handbook is considered one of the biggest bargains in radio today. Over 100,000 homes rely on the I. C. S. Radio Handbook to take the mystery out of radio. Why experiment in the dark when you can quickly learn the things that insure success? Hundreds of illustrations and diagrams explain everything so you can get the most out of whatever receiver you build or buy.

It contains: Electrical terms and circuits, antennas, batteries, generators and motors, electron (vacuum) tubes, many receiving hook-ups, radio and audio frequency amplification, broadcast and commercial transmitters and receivers, wave meters, super-regeneration, codes, license rules. Many other features.

A practical book. Written and edited by experienced engineers, in plain language. Something useful on every one of its 514 pages. The authority that covers every phase of radio, all under one cover in one book at a surprisingly small cost. Don't spend another cent for parts, turn a dial or touch a tool until you have mailed \$1.50 for this I. C. S. Radio Handbook.

Send \$1.50 at once and get this 514-page I. C. S. Radio Handbook—the biggest value in radio today. Money back if not satisfied.

TEAR OUT HERE

International Correspondence Schools
Box 8261-C, Scranton, Penna.

I am enclosing \$1.50. Please send me—post-paid—the 514-page I. C. S. Radio Handbook. It is understood that if I am not entirely satisfied I may return this book within five days and you will refund my money.

Name

Address

Check here and enclose \$1 if you wish the cloth-bound edition.

REDUCE STATIC

Pat. Pending
690459



by using our super-sensitive
Omni-Directional Aerial
Collapsible, Ornamental,
Mechanically Perfect

Can be used either as a loop or antennae inside or outside. A wonderful value featured at a price within the range of all. Ask your dealer or send order direct

\$10.00
Prepaid in U. S.

The Portable Globe Aerial Co.
1602 Locust Dept. 45 St. Louis

\$1.00 Brings "RADIO" for 6 Months

(Continued from Page 56)

pulp, paper and lumber industries of the country gave their services. The result was really amazing. Forest fires along the lines of the Canadian National Railways, and with more than 9,000 miles of such territory they serve a greater forested area than any railway in the world except the trans-Siberian—showed a decrease of more than 50 per cent, and a most encouraging decrease resulted throughout the Dominion.

Another important indirect result has been the contentment of those who have to live in sparsely settled districts of the north and west. Most farm houses in Western Canada are now equipped with radio receiving sets. From some of the stations daily quotations of the grain and cattle markets are radiocast and each evening from one or more of the prairie stations the air holds entertainment for those who have the means to listen. The obstacle of distance has been overcome. Geography has been eliminated. The settler on the prairie, the trapper on the mountains and the logger in the woods, no longer have to go to the city. The city comes to them. Only those who have seen for themselves how the dread of isolation has retarded the progress of our development in our West and in our hinterland, can understand the tremendous part that the radio of the Canadian National Railways is playing in the lives of these, the last pioneers.

One more feature alone needs to be mentioned and it has to deal with the value of radio in the administration of the railroad. It is doubtful if even many Canadians understand the magnitude of their National Railway System. It comprises more than 23,000 miles of operated tracks and it touches every province, every capital and every important city and town. But few understand what this 23,000 miles mean. Few know that to travel every foot of that track it would be necessary to remain for practically three weeks on a train traveling without a stop at the rate of fifty miles an hour. That being the case, it is not hard to conceive that some difficulties are experienced by those charged with the administration of the property, in maintaining that personal touch with all officers and employees which is essential in insuring the success of the enterprise. It is beyond the ability of a human being to meet personally every member of such a wide-flung organization numbering more than 110,000 members. In surmounting this difficulty radio has played its part. At regular intervals officers of the company, including the president and his executives, talk to other officers and employees from a radiocast station. The result has been a strengthening of morale, the establishment of an intimacy between distant but co-related portions of the system that is most heartening, and a general improvement of service.

The Panels That Produce Results

A superior panel will increase the efficiency of your reception through reducing surface leakage. You can be certain of this if your set is built with

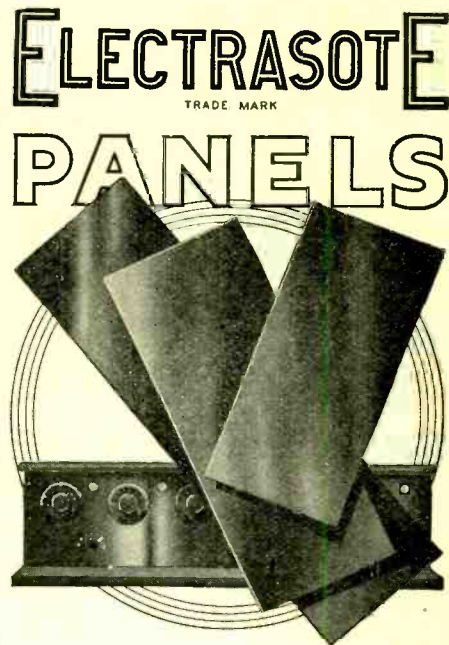

These beautifully finished panels will neither warp nor change color. They are scientifically constructed to reduce surface leakage to a minimum, hence assure increased efficiency of the set.

One of the many well-known "sote" products introduced by The Pantasote Company, Inc., Electrasote Radio Panels are sold strictly on their merits—yet are

Lower Priced
than other standard panels

Make your Set an "Electrasote Panel Set"—and get results!

On Sale at Good Radio Dealers



M. M. FLERON & SON, Inc.
Sole Sales Agents
Trenton, New Jersey

The MOZART Baby GRAND

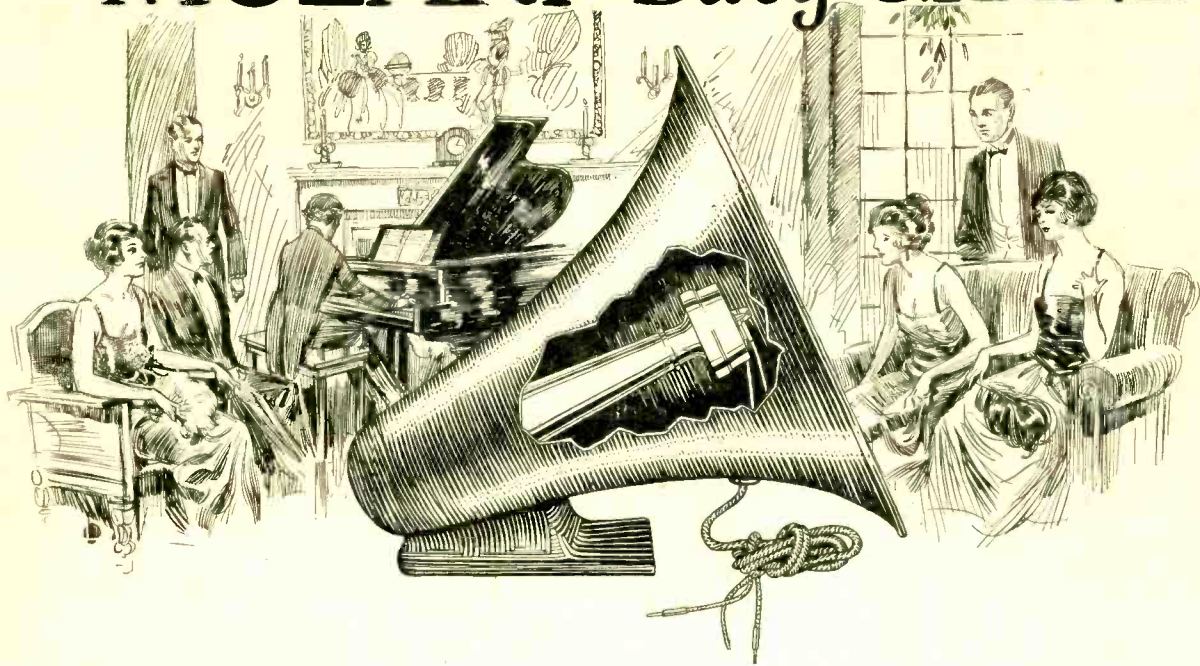

S E R V I C E

NO piece of radio apparatus is really sold unless it stays sold, unless the purchaser every day is more satisfied with his purchase than he was the day before.

"Must admit such courtesy is very seldom accorded a purchaser by other companies. It is a real pleasure to deal with a firm which meets one more than halfway. I believe that your product will be a decided advantage to my line of cabinet sets."

(Signed) L. B. HIMMEL, 3609 Fifth Ave., Des Moines, Iowa.

P R I C E S

(West of the Rockies)

Baby Grand Reproducer, with gold plated unit, black and gold crackle or extra heavy coated all black satin finish	\$12.50	Electro-magnetic unit (fits almost any horn or phonograph) with cord, Nickel Plated.....	\$4.50
		Gold Plated	\$5.50
		Mozart Special Headset.....	\$6.00

If your dealer cannot supply, order direct

WEST COAST REPRESENTATIVES:

Nelson-Rude Co., 16 California St., San Francisco, Cal.

Jaeger Radio Co., 4505 Thirty-sixth Ave., N.E., Seattle, Wash.

M O Z A R T G R A N D C O.

Manufacturers of Fine Instruments

N E W A R K, N. J.

U. S. A.

BURGESS RADIO BATTERIES

Quality at Every Price

Cabinet or table space many times determine the size and type of radio batteries selected by the user

Burgess manufactures a battery for every radio circuit and tube. Your choice of any one of many types involves no sacrifice of economy or service hours. The value and quality of Burgess Radio Batteries are constant—your satisfaction assured

Ask Any Radio Engineer

Write to 223 Burgess Engineering Building, Madison, Wisconsin for the Burgess Radio Compass. It is amusing, unusual and useful.



Burgess 'C' Batteries improve reception economically.



One of several sizes of Vertical 'B' Batteries.



Standard Burgess Radio No. 6 'A' Battery "Over Twice the Life."

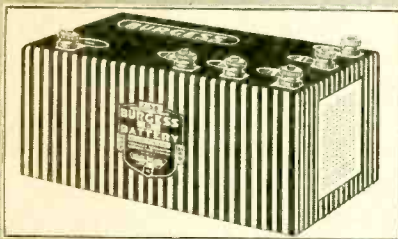

Burgess block shape 'B' Batteries are made in numerous types and voltages.

BURGESS BATTERY COMPANY
Engineers DRY BATTERIES Manufacturers
Flashlight - Radio - Ignition - Telephone
General Sales Office: Harris Trust Bldg., Chicago
Laboratories and Works: Madison, Wisconsin
In Canada: Niagara Falls and Winnipeg

TUNED R. F. AMPLIFIERS

(Continued from Page 19)

ductance. The radio frequency voltage across this inductance is impressed between the grid and filament of the detector tube. In operation the grid circuit of the radio frequency amplifier is tuned to the incoming signal and the inductance in the plate circuit raised almost to the point where oscillations are produced due to regenerative effect. As has been stated in a previous article this point is usually reached before the natural frequency of the variometer has become as low as the frequency to which the grid circuit is tuned. This is therefore not a tuned plate circuit amplifier. Such radio frequency voltage as does exist across the plate variometer is impressed across the detector and there is no reason why satisfactory results cannot be obtained.

The reader should appreciate the fact that the circuits shown as illustrations of the principles involved are subject to endless variation and offer a very fruitful field for investigation. However, too much importance cannot be attached to the necessity of understanding the fundamental principles involved as mere haphazard trying of circuits without a knowledge of what is happening is not likely to lead to results which can be interpreted and made use of in the future. It is the writer's hope that these discussions of circuits from the standpoint of theory of operation rather than with the intention of presenting them as models will be helpful.

**\$1.00 Brings You "RADIO"
for Six Months. Subscribe
Right Now!**

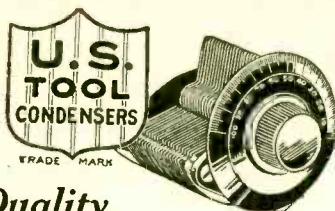

Quality —Based on Perfection of Parts

A condenser is no more efficient than its weakest feature—a thought borne in mind in designing the U. S. Tool Condensers. As a result, the perfecting of parts has led to the nearest point approaching condenser perfection. Inquire about Type 6 with the micrometer dial.

Factory Guarantee

Write for Literature

Coast representatives:

Radio Electric Distributing Co.
1113 Wall St., Los Angeles, Cal.

U. S. TOOL COMPANY, Inc.

114 Mechanic St. Newark, N. J.

Mfrs. of special tools, dies, jigs,
automatic machinery and sub presses

Earn \$100 a Week in RADIO! Easy to Learn at Home

\$50 to \$300 a week for fascinating easy work—wonderful future. Hundreds of big paying positions in this huge new industry!



More Money for YOU in Radio

THOUSANDS of Radio Experts are needed to design, repair, maintain, sell radio apparatus, to operate broadcasting stations, as ship and land operators, to go into business; to instruct, demonstrate, superintend and for scores of other big paying radio jobs.

And now, you can easily become a Radio Expert. Studying at home in spare time, you can quickly qualify for a splendid Radio position. Astonishingly small cost. Famous radio instructors give you individual help by mail. Training GUARANTEED.

Free Employment Service

Hardly a week goes by without our receiving urgent calls for our graduates. "We need a competent Radio Engineer"—"We want men with executive ability in addition to radio knowledge to become our local managers"—"We require the services of several resident demonstrators"—these are just a few small indications of the great variety of opportunities open to our graduates.

FREE—Receiving Set and Special Parts

Our course of practical instruction includes not only several of our own special patented instruments, but in addition we furnish material and diagrams for building receiving sets—all without additional cost. This is an absolutely complete course which qualifies you for the big-pay jobs in Radio.

We Help You to Big-Pay Positions

Scores of young men who have taken our course are already earning from \$75 to over \$200 a week. Merle Wetzel of Chicago Heights, Ill., advanced from lineman to Radio Engineer, increasing his salary 100% even while taking our course! Emmett Welsh, right after finishing his training started earning \$300 a month and expenses. Another graduate is now an operator of a broadcasting station PWX of Havana, Cuba, and earns \$250 a month. Still another graduate only 16 years old is averaging \$70 a week in a radio store, and we help our graduates to positions like these.

Send for FREE BOOK

There's more money for YOU in Radio. Find out what this field has meant to hundreds of our graduates—and how you too can profit in it. "Rich Rewards in Radio" has just been printed. It is filled with the latest Radio facts, figures and illustrations of tremendous interest to you. Right now—if you are at all ambitious—send for this valuable free book. Write now while our Special offer is still open. Fill out the coupon—and mail it now! NATIONAL RADIO INSTITUTE, Dept. 10EB, Washington, D. C.

National Radio Institute, Dept. 10EB
Washington, D. C.

Without obligation send me your book "Rich Rewards in Radio," which tells all about the opportunities in Radio, how spare time study at home will qualify me quickly as a Certified Radiotician so I can get one of these splendid positions, and how your Employment Service helps me to secure a big pay job.

Name..... Age.....

Street.....

City..... State.....

CROSLEY AGAIN LOWERS PRICES

Big Reduction in Famous Trirdyn and other Radios

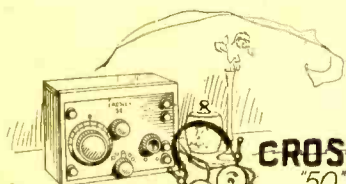

\$14.50

CROSLEY
"50"
One Tube

The biggest
selling radio
in the world.

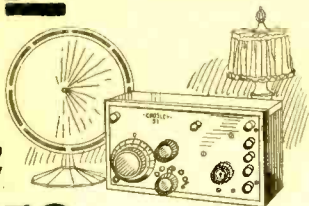

\$18.50

CROSLEY
"51"
Two Tube

Two
Tube

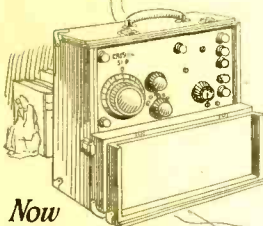

CROSLEY
"51" Portable
Two Tube

Now

\$23.50

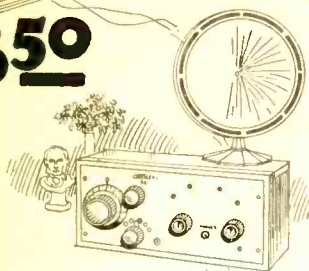

\$30

CROSLEY
"52"
Three Tube

Three Tube

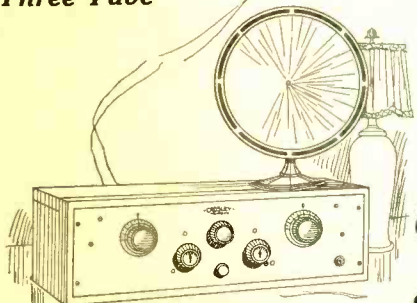

Now CROSLEY
"TRIRDYN"
\$50

The biggest selling high grade receiver on the market—the Crosley Trirdyn—reduced from \$65 to \$50.

The Trirdyn Special—the beautiful Model with cabinet to house batteries—formerly \$75, now \$60.

The Crosley 51-P, a tremendous seller at \$25, reduced to \$23.50.

We unhesitatingly state that these sets, together with the other Crosley Radios, represent the biggest values ever offered.

CROSLEY RADIOS JUSTLY POPULAR

Only the less expensive Crosley Radios have exceeded the Trirdyn in sales. This deserved popularity of the entire Crosley line is the result of extraordinary performance at a very low price.

Crosley Radios cost less originally, use fewer tubes and consume much less battery current. At the same time they give results not equalled by receivers costing a great deal more and using two or three additional tubes.

The unique Trirdyn circuit—a combination of Armstrong Regeneration, Radio Frequency Amplification and Reflexed Audio Amplification—has proven beyond a doubt that the features of selectivity, volume and ease of operation can be obtained with three tubes better than heretofore has been possible with five or even six.

Hundreds of voluntary letters have come to us, telling of the unparalleled foreign reception during international test week with Trirdyns and all other Crosley Radios; even the little one-tube Crosley 50 at only \$14.50.

It is this continued remarkable performance that has created such a tremendous demand for Crosley Radios. And it is this great popularity that now allows us to decrease our production costs and pass this large saving along to you.

NEW CROSLEY MODELS

In order to allow even a greater selection, three new Crosley Radios have been added to our extensive line. Taking its place with the well known Crosley 50 and Crosley 50-P is the leatherette covered, one-tube 50 Portable, a utility set in which the dealer can quickly make the necessary connections and allow you to carry it home complete.

The new Crosley 51 Special, a two-tube receiver similar to the Model 51, is housed in a cabinet large enough to hold the necessary batteries and has a sloping panel.

Similar to the Crosley 52, but with sloping panel and cabinet to house the batteries is the new Crosley 52 Special.

These additional receivers make the Crosley line absolutely complete—A radio for all tastes and every pocketbook. See illustrations for prices.

No matter what appeals to you most in a radio, you will find that point outstanding in a Crosley.

Most good dealers handle Crosley Radios. You Will Make No Mistake in Buying One.

All Crosley Receivers contain the famous Armstrong Regenerative circuit, and are licensed under the Armstrong U. S. Patent No. 1,113,149

As is customary, prices do not include tubes, phones, loud speakers or batteries

Prices West of Rockies, add 10%

Write for Complete Catalog

3 Tubes do the work of 5
In a **CROSLEY Trirdyn**

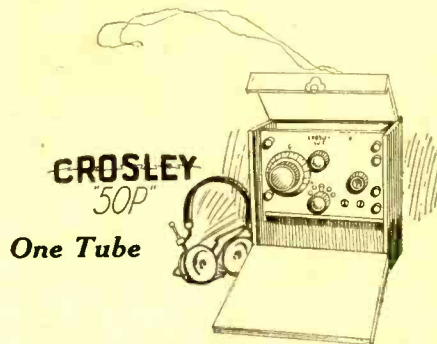

CROSLEY
"50P"
One Tube

\$16

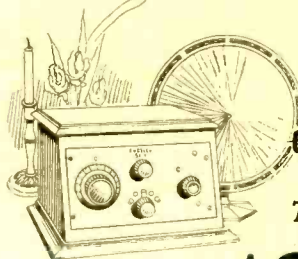

CROSLEY
"51" Special
Two Tube

\$23.50

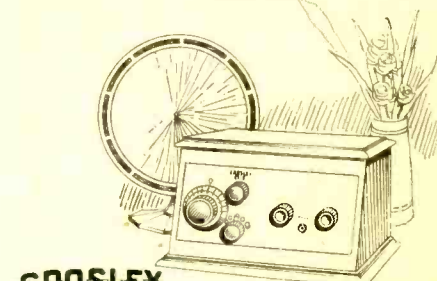

CROSLEY
"52" Special
Three Tube

\$35

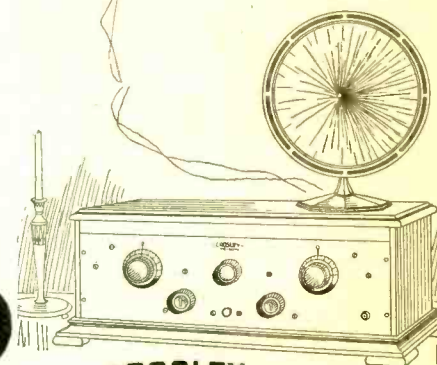

CROSLEY
"TRIRDYN" Special
Now **\$60**

THE CROSLEY RADIO CORP.

319 Sassafras Street

POWEL CROSLEY, JR., President

Cincinnati, Ohio

Crosley owns and operates Broadcasting Station WLW

Tell them that you saw it in RADIO

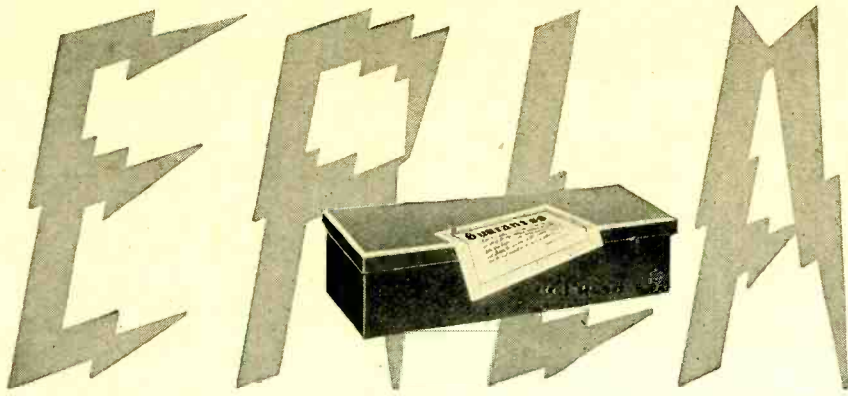

Supereflex Means MORE POWER PER TUBE

Erla Supereflex makes tubes do triple duty. One tube actually does the work of three that would be needed otherwise. Three tubes do the work of five, unquestionably! That is why simple, compact, inexpensive Erla Supereflex receivers equal or surpass the performance of costliest, temperamental multi-stage radio sets.

More power, tube for tube, is basic in Erla Supereflex. Nothing else can "make up for it." Greater power in Erla Supereflex just simply means finer radio, which you can afford.

For you yourself can confidently build these matchless Erla circuits with Erla Supereflex CIR-KIT.

CIR-KIT is a complete array of Erla Scientific Precision Apparatus, especially created to make Supereflex possible. CIR-KIT provides clear, simple instructions for perfect assembly. Blueprints are full size. The panel is pre-drilled for you. The baseboard is marked to locate every unit accurately. The famous Erla Solderless Connectors do away with soldering entirely.

With screwdriver, pliers and CIR-KIT you are sure of a set that will make you proud, both for appearance and performance. The cost is very moderate. Yet the range, volume, selectivity AND TONE PURITY are rarely equaled at any price, because Supereflex does give you more power, tube for tube.

Electrical Research Laboratories
 Department H, 2500 Cottage Grove Avenue, Chicago
 Coast Representatives: Globe Commercial Co., Los Angeles, San Francisco, Seattle

CIR-KIT

Make \$100 a Day **FREE INSTRUCTION TELLS HOW**

Many Sales Are Half Profit When you sell our nationally advertised radio sets and supplies. We Guarantee your success, under the "Gould Plan," by allowing you to return goods which you do not sell. It would pay you to get our price list and free instructions "How To Sell Radio." Write for it.

Federal Radio Co. 109 East 13th St. Kansas City, Mo.

See the New! - - -

MONTROSE LOW LOSS CONDENSER \$2.50

A new efficient condenser at a new low price. 23 plate, cap. .0005.

UNITED RADIO LABS. of the Montrose Mfg. Co.
 1333 Fulton St. Brooklyn, N. Y.

"COMO DUPLEX"

The World's Standard Push-Pull Transformer, \$12.50 per pair. Send for descriptive literature. COMO Apparatus Corp., 446 Tremont St., Boston, Mass. Washington and Oregon Representative C. E. GAY

166 Lownsdale St., Portland, Oregon

The SATURN Perfect Jack and Automatic Plug. Your order filled by mail promptly. Every article absolutely guaranteed.

The SATURN Mfg. & Sales Co., Inc.
 48 Beckman Street, New York, N. Y. Dept. B

Write for Literature

Slight Touch Releases the Tips

A KISS IN THE DARK

(Continued from Page 23)

plaining his plan, Willie broke in, "Gosh, that's the best yet. Oh, boy, you sure gotta good one, Jimmy."

For the next twenty minutes they talked and talked, arranging the details of Jimmy's bright idea.

"C'mon over to my place right after school tomorrow afternoon," said Jimmy as he started home, after they had laid their plans.

"All right, and I'll bring Dick's choke coil amplifier with me."

"An' don't forget to meet me at recess tomorrow so's we can get a good bunch of fellers to come around tomorrow night," added Jimmy, stepping out of the door.

Jimmy walked home quickly, but paused when he came to the front porch.

"Gosh," he exclaimed, "That funny faced guy is still here, 'cause she's got all the lights turned down. Guess I'll s'prise them."

Opening the door very gently, he slipped down the hall and through the archway, only to trip himself over a chair.

"What tha Sam Hill!" he muttered. "What's comin' off here, movin' all the furniture out of place?"

"James Watson, you horrid boy!" cried Sister Helen. "How dare you sneak in on us? You go right to bed or I'll —"

With an angry grunt Jimmy left for his room.

Shortly after three o'clock the next afternoon, Willie Smith called softly at the Watson's back door. He had a large bundle in his arms.

"All clear," answered Jimmy. "Ma's not at home, but she may come in any time. Let's make it snappy."

Jimmy kept watch at the front door while Willie busied himself with the work at hand.

"Where can I stick this choke-coil amplifier so's they won't see it?" asked Willie.

"Put it in the fireplace, behind that bunch of ferns. And step on it, kid."

In a few minutes Willie had connected up the amplifier, run one pair of wires to the Watson's receiver, and another downstairs to the cellar. Then he undid the telephone wires, running a pair from the phone to the radio set. Jimmy, his face pressed against the window, kept on the lookout for intruders.

"Let's try it out," suggested Willie after he had finished making the connections. "You sit on the sofa and talk natural and I'll take the loudspeaker downstairs and see how it sounds."

In a few minutes Willie returned, his face all aglow with excitement.

"Works like a million," he announced. "Say, boy, we can charge ten cents instead of a nickel for that show tonight."

(Continued on Page 64)

The Supreme Pleasure of Radio is secured only from a set constructed by yourself, *but* be sure to use *reliable* parts

IN THE NEW YORK GROUNDED ROTOR scientific designing, together with the highest grade of materials and instrument workmanship combine to produce a condenser that is in a class by itself---no other condenser manufactured incorporates so many *actual improvements*.

.0005 (23 plate) without Vernier **\$4.50**

Geared Vernier attachment, complete, \$1.50

OUR STANDARD NON-GROUNDED CONDENSERS are made in four sizes with or without vernier — are universally recognized for their efficiency, workmanship and low price—made possible by large production.

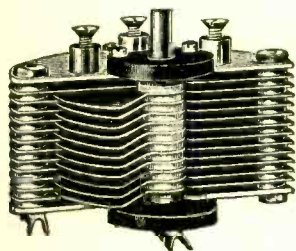
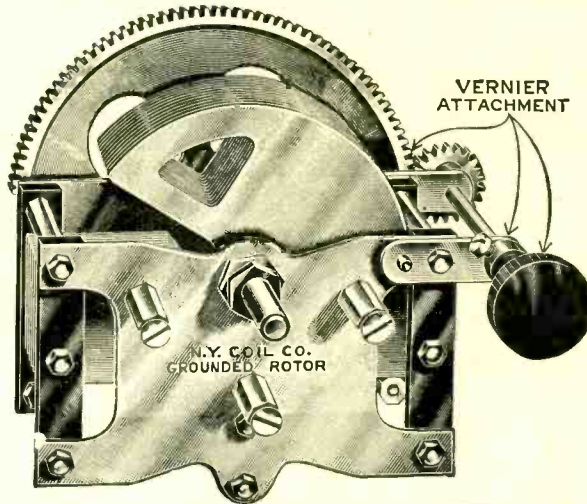

Price with Vernier Knob and Dial, 23 Plate, \$3.50
Without Vernier, 17 Plate, \$1.80. 23 Plate, \$2.00. 43 Plate.....\$3.00



New York Distortionless Audio Amplifying Transformers are the standard by which others are judged. 4¼ to 1 ratio correct for all style tubes.

Price \$4.00

Tuned Radio Frequency Transformers, with 17 Plate Condenser attached\$4.50

BY PASS CONDENSERS	
.05	\$.90
1 Mfd.	1.25

NEW YORK PRECISION MICA FIXED CONDENSERS

"More Uniform Capacity"



Type B



Type A—No Clips

Adopted by leading Heterodyne manufacturers on account of truthful capacity rating. This is the only laboratory precision-built condenser on the market, yet sold at a commercial price. It is standard equipment with some of the largest and most discriminating set manufacturers.

Guaranteed for capacity and against leakage or breakdown.

The following sizes always in stock:

Capacity		Retail Price
.0001	Mfd.\$.35
.00015	"35
.00025	"35
.0005	"35
.001	"40
.002	"40
.005	"60
.006	"75

.00025, with Grid Leak Mounting Attached, 45c list
Type C

NEW YORK COIL COMPANY

338 Pearl Street, New York City, N. Y.

PACIFIC COAST MARSHANK SALES COMPANY, 926 Insurance Exchange Building, Los Angeles, California, also San Francisco, Portland

(Continued from Page 62)

"Cheese it, Willie," broke in Jimmy. "Here comes somebody. We gotta beat it. C'mon, follow me."

At supper that evening Jimmy did not display his usual appetite. He gulped down a few bits of food, seemingly intent on getting through in a hurry.

"No you don't," announced Papa Watson. "You sit right there until we have all finished. You're not going out tonight, young man."

"Er, a, I don't feel very good tonight. Guess I better go upstairs," said Jimmy, rising from his seat.

"I don't understand what's the matter with him, Herbert," said Mrs. Watson to her husband after Jimmy had left the room. "He's been nervous all day long."

"Probably has a licking coming to him at school," replied Mr. Watson. "Well, if he gets one there, he'll get another when he comes home."

But Jimmy did not go to his room. Just as Papa Watson was talking about Jimmy's getting another one at home, our hero was busy ushering a number of boys down the cellar steps, admonishing everyone to be very quiet. Willie was engaged in collecting ten cents from each youngster entering the large basement.

The two boys had their hands full getting everybody quietly seated on the various boxes and barrels about the basement. The visitors seemed rather skeptical about the program, especially after parting with a dime apiece.

"Looks like we'll take in enough to buy a new tube for the club's set," said Jimmy to Willie. "There won't be no show, though, if these kids don't keep quiet," he added.

After much persuasion and hard work, Jimmy and Willie got every one quiet and in place. Then Jimmy stepped on a box, assumed a dramatic pose, and addressed the audience:

"Tonight we're going to give you some lessons on how to make love. This is going to be broadcast to you by my sister, Helen Watson, and her feller, Clarence Atherton, from the living room of the Watson home. You gotta keep pretty still because—"

"Ting-a-ling-n ng!" went the loud-speaker.

"There's the doorbell. Mr. Atherton is now arriving," announced Jimmy.

"Squ-blish! rrrrunch!!" came from the horn.

"Mr. Atherton and Miss Watson are now doing the mush."

"Squi-bliss-ss-sh!" Grrrunch," it continued.

"Oh, Clarence, I've missed you so. Kiss me again." "My love, my darling, come to my arms. Twenty long hours have separated us, my Queen." "My hero, my big, big man —"

"Calling that skinny bird a hero!"



New
KIC-O "B" Battery
and
Double Potential
Charger

PRICES

PZ indicates panel type with switches.
CZ is plain type without switches.

Voltage	M.A.H.	Type PZ	Type CZ
130	2500	\$36.00	\$33.00
100	"	27.50	24.50
70	"	21.50	18.50
45	"	16.00	14.50
22½	"		7.50

KIC-O Chargers

Type K-1 Single unmounted...	\$1.50
Type K-2 Single mounted.....	3.50
Type K-3 Multi-Polar mounted	5.00
KIC-O Special Charger Chemicals (one cell).....	.50

See your dealer or clip the Coupon

KIMLEY ELECTRIC CO. INC.,
2666 Main St., Buffalo, N. Y.
Gentlemen:

Please send items checked below to undersigned address:

KIC-O "B" Battery Type.....
Voltage..... Price.....
KIC-O Charger (specify which)——

Full information regarding KIC-O equipment. Send C.O.D. subject to guarantee of satisfaction or money back to:

Let KIC-O BATTERIES help you to get those far-away stations

The real thrill for a true radio fan comes when he tunes in on a new station further away than any he has ever heard before. That is one of the reasons why we are continually receiving hundreds of letters of high praise for KIC-O Storage "B" Batteries. Each letter proves more conclusively the unrivalled superiority of the KIC-O for better, clearer, truer radio reception.

Nickel-zinc construction of KIC-O elements preserved by a special alkaline solution give KIC-O Batteries practically unlimited life. They give an even, dependable discharge over long periods of service and are not harmed by idleness or overcharging.

And with the KIC-O single or double potential charger, which charges the battery from any 110-volt A.C. lighting line, you will have a real permanent power plant which will last for years.

All KIC-O products are backed by a satisfaction or money back guarantee.

Ask your dealer or write for full information today.

Kimley Electric Co., Inc.
2661 Main Street, Buffalo, N. Y.

RADIO BIG MONEY IN A BIG FIELD

Be a RADIO EXPERT. Make big money. Win success in this new uncrowded field. Trained men needed. Learn quickly, at home in spare time, to construct, install, operate, repair, maintain and sell radio equipment.

RADIO EXPERTS EARN \$3,000 to \$10,000 a year

Short course, low cost, easy terms, money back guarantee.

FREE Wonderful tube receiving set of latest design. Range of over 1000 miles. Write today for "RADIO FACTS."

A.S. Mohaupt, Radio Eng. Radio Association of America
4513 Ravenswood Ave., Dept. 83 Chicago

100 to 1

AMERICAN BRAND CONDENSER

with the Worm Drive **VERNIER**

23 PLATE \$5.00 only

For Sale Everywhere

AMERICAN BRAND CORPORATION
8 WEST PARK ST. NEWARK, N. J.

ARE YOU A SUBSCRIBER?

broke in Jimmy. "He'd jump on a chair if he saw a mouse!"

"Sweetheart," the speaker went on, "I've yearned all day for your lips. Tell me again that you love me." "I love you, adore you, worship you, my beloved knight." "Then fly with me, my sweet."

"Hey, pipe down," Jimmy cried as the crowd laughed louder and louder. "You'll ruin the show if you don't cut the noise!"

"Helen, queen of my dreams," came Clarence's voice shakily through the speaker, "Say you will come with me. Let us elope, my love, my —"

"Jumpin' catfish!" Jimmy ejaculated. "They're gonna beat it."

The crowd became deathly still, as the horn went on:

"I'll come for you at midnight tonight. Say you will, dear—say it! Say it!"—"Clarence, do you really love me?" "My love is as deep—aye—deeper than the chest of the mighty Hercules!"—"Then I shall be ready at midnight. You must go now, dear, for I must get everything ready. You're not giving me much time, you impatient boy!" "Sqi-bl-ish! Grrrunch!"

Then the sound of the door. Then silence.

The listeners in the basement looked at each other blankly. Then Jimmy arose to the occasion.

"We gotta bust this thing up," he announced, "And we wanna do it right."

The crowd listened with open mouths and bated breath.

"We gotta be here half an hour before midnight," continued Jimmy. "All you fellers that can sneak out, meet Willie 'n me behind the fence at eleven thirty. Then we'll all jump up and make a lotta noise, so's to wake everybody up. Then we'll beat it when the folks come out."

After pledging themselves to secrecy, the assembly adjourned until the appointed hour.

THE night was deathly still. The world was quietly sleeping, while the little stars kept watch from above. Suddenly the silence was broken by the doleful midnight toll of the clock in the Watson hallway. Then quiet again.

A light roadster coasted up to the curb and came to a stop. A tall, slender figure climbed out, looked around cautiously, then tiptoed across the grass to the porch.

Barely, almost inaudibly, came the squeak of an opening door. A slight figure slipped out and into the arms of the waiting visitor.

Sqi-bl-ish! Grrrunch!!

"Now, all together!!" came a voice from behind a tree.

Then there arose a shout from all
(Continued on Page 66)

A Wonderful Radio Achievement! The First All-Glass Socket

Countless tests have proven glass to be the most effective insulation available to radio. After exhaustive research, our engineers have developed a new—idea Socket made entirely of VIRALON—a special glass processed for 100 per cent electrical efficiency.

VIRALON Glass is absolutely heat and moisture proof, and unaffected by those influences that commonly make rubber, rubber derivatives, porcelain and vitreous products so inefficient.

Duray All-Glass Sockets eliminate most of the so-called "tube

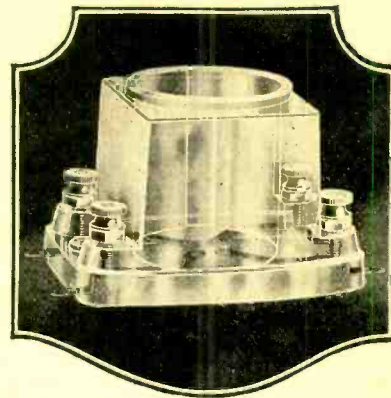

noises"—cut down power losses—prevent short circuits—and eliminate radio frequency leakage.

DURAY RADIO CORPORATION

Dept. 14, 263 Washington Ave., Newark, N. J.

DURAY

ALL-GLASS
VIRALON
SOCKET

You'll like all the exclusive Duray features—the all-glass construction—the one-piece contact strips—the knurled contact spots (corrosion-proof)—the handy soldering terminals.

Price \$1.25 (standard size)
Packed in attractive carton

Until all dealers have been stocked, you can be supplied direct from the factory at the retail price, plus 10c for packing and postage.

Wholesale Distributors of
Nationally Known
RADIO SUPPLIES
DEALERS—Send for price list and discount sheet
COSMOPOLITAN RADIO
APPLIANCE CO., INC.
25 Church Street, New York, N. Y.

NA-ALD

Na-aid Deluxe Sockets are the only ones with these 3 exclusive features—lowest loss, lowest capacity and positive side-scraping contact. Send for booklet and laboratory test. Alden Mfg. Co., Dept. G1, Springfield, Mass.

SEE BIG OFFER ON PAGE 55

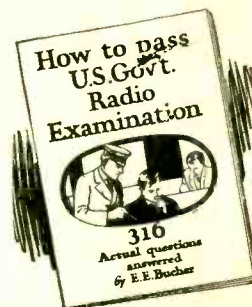

50c

RADIO INSTITUTE OF AMERICA
322 Broadway, New York City

PASS the U. S. Government Commercial or Amateur Radio License examination. This book will help you do it. Send fifty cents in stamps or coin for your copy—postage prepaid to any point in the U. S., Canada or Mexico.

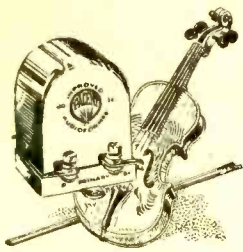

Fidelity

Just as the rare old violin expresses the finest instincts of its master, so does the Pacent Improved Audioformer bring out the best in any radio set.

It gives faithful, pure and undistorted reproduction over the entire band of sound frequencies, with an unusually high amplification factor throughout the entire range rather than at one high peak.

You will be more enthusiastic than ever about your set when you hear it with Pacent Improved Audioformers. Order a pair today from your dealer.

Write for complete catalog of Pacent Radio Essentials.

PACENT ELECTRIC COMPANY, Inc.
91 Seventh Avenue, New York City

Chicago
Washington
San Francisco
Philadelphia
Jacksonville

Minneapolis

Pacent
RADIO ESSENTIALS

St. Louis
Boston
Birmingham
Buffalo
Detroit

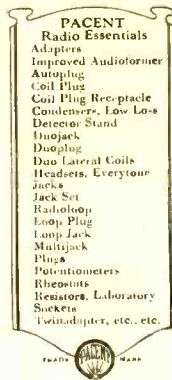

PACENT
Radio Essentials
Adapters
Improved Audioformer
Autoplug
Coil Plug
Coil Plug Re-tractor
Condensers, Low Loss
Detector Stand
Duojack
Duoplug
Duo Lateral Coils
Headsets, Everytone
Jacks
Jack Set
Radioloop
Loop Plug
Loop Jack
Multi-jack
Plugs
Potentiometers
Rheostats
Resistors, Laboratory
Sockets
Transformer, etc., etc.

"DON'T IMPROVISE - PACENTIZE"



Double Range Radio Table Voltmeter

THIS RADIO TABLE VOLTMETER, Weston Model 489, with ranges of 150/7.5 volts was especially designed for the radio enthusiast. It is beautifully made with a strong Bakelite case. Its portable form, accuracy, dependability and range combination makes it an ideal all purpose voltmeter around the radio set.

For checking filament and grid voltages, locating loose or broken connections, testing new hook-ups, for improving reception and for materially increasing the useful life of the tubes through close regulation of the filament voltage.

Write for Booklet "J"

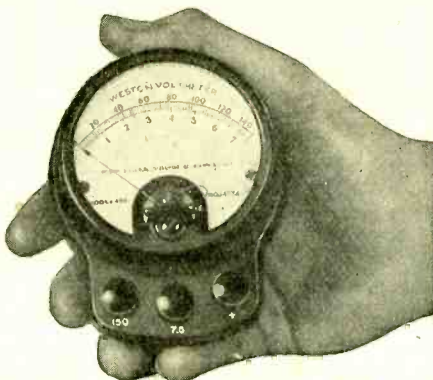

**WESTON ELECTRICAL
INSTRUMENT CORP.**

156 Weston Avenue, Newark, N. J.

Electrical
Indicating
Instrument
Authorities
Since 1888

WESTON

STANDARD - The World Over



HERCULES

AERIAL MAST

20 Ft. Mast \$10
40 Ft. Mast \$25
60 Ft. Mast \$45

All steel construction. Complete with guy wires and mast-head pulley. We pay the freight.

S. W. HULL & CO., Dept. G-4
2048 E. 79th St., Cleveland, O.

Write for
literature
and
FREE
Blueprint

**New LeFAX RADIO
HANDBOOK—\$2.00**

(Seventh Edition)

in bound form. For sale by
"RADIO," San Francisco

"B" BATTERIES

AN

EVEREADY

PRODUCT

At Standard Prices

43V. Batteries, tapped
22½ V. Batteries, Navy Type
22½ V. Batteries, Commercial Type

Latter two types especially adapted to
Cunningham and Radiotron Tubes.

Postage Prepaid Anywhere in U. S.

ETS HOKIN & GALVIN

Wireless Engineers

10 Mission Street San Francisco

RADIO CABINETS

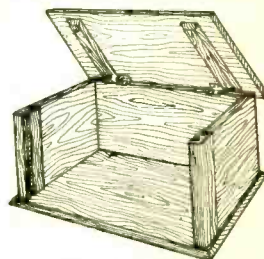

The A-1 Standard Radio Cabinet
Prices on unfinished cabinets:

Panel Size	Deep	Price	Panel Size	Deep	Price
7x12	8	\$3.00	7x24	10	\$4.50
7x12	10	3.25	7x26	8	4.75
7x14	8	3.25	7x26	10	5.00
7x14	10	3.50	7x27	8	5.00
7x18	8	3.75	7x27	10	5.25
7x18	10	4.00	7x28	8	5.25
7x21	8	4.00	7x28	10	5.50
7x21	10	4.25	7x30	8	6.25
7x24	8	4.25	7x30	10	6.50

Hand Rubbed Finished \$2.00 Extra
A-1 Standard Radio Cabinets are constructed of Philippine mahogany throughout. The ends are grooved to slide panel in. Tops and bottoms moulded all around.

TERMS: Cash with Order. All prices F. O. B. Los Angeles. Bring or send this ad.

A-1 Woodworking Co.

Dept. R33, 1338-1342 San Julian St.
Atlantic 7923 Los Angeles, Cal.

Subscribe to "RADIO" ---\$1.00 brings it for 6 Months

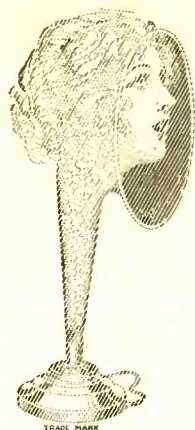

Atlas

TRADE MARK

RADIO REPRODUCTION speaker

The ATLAS Unit with adjustment and compound diaphragm — the heart of the ATLAS Speaker. "It gives the best that's in your set."



MULTIPLE ELECTRIC PRODUCTS CO., Inc.
365 Ogden St., Newark, N. J.
(Dept. E.)
New York Philadelphia
Boston Baltimore Detroit
Pittsburgh Chicago
St. Louis San Francisco
Marconi Wireless Telegraph Co.
of Canada, Ltd.
Sole Canadian Distributors

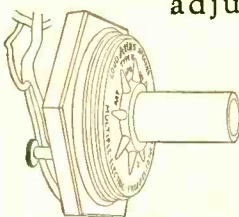

ATLAS Products are guaranteed

All parts for The De Luxe HAYNES SUPER-HETERODYNE

Described by A. J. Haynes in February "Radio"

Reprints of Mr. Haynes' Original Article

Exactly as it appeared in February "Radio" mailed anywhere upon receipt of 4c in stamps to cover cost of handling and mailing.

Don't miss this important article. It describes the construction and operation of the latest and most improved of all super-heterodynes.

Haynes-Griffin alone can supply you with the new and specially designed apparatus which is essential to the proper operation of this remarkable new super-heterodyne. Haynes-Griffin Mail Order Service will give you immediate delivery on any of the following items called for by the designer.

Parts specified by Mr. Haynes

3 Haynes-Griffin .0005 Geared Vernier Condensers.....each	\$8.00	2 .00025 mfd. Dubilier Condensers, with leak mtg.....	\$.45
1 Rathbun 3-Plate Condenser.....	1.00	1 .006 mfd. Dubilier Condenser.....	.75
1 Haynes-Griffin 200-400 Ohm Potentiometer.....	.75	2 .5 mfd. Dubilier Condensers.....each	.90
1 Haynes-Griffin 20 Ohm Rheostat.....	.75	1 .002 mfd. Dubilier Condenser.....	.40
3 Benjamin Standard Base Sockets each.....	1.00	2 .1 meg. Daven Resistances.....each	.50
6 Hoosick Falls Type 199 Sockets each.....	.50	1 2 meg. Haynes-Griffin Resistance.....	.50
1 Haynes-Griffin Type 91 Audio Transformer.....	5.50	1 1 meg. Haynes-Griffin Resistance.....	.50
1 Resistor Coupler (Daven).....	1.50	3 Amperites with mounting.....each	1.10
1 Special Oscillation Coupler.....	3.25	8 Eby Binding Posts.....each	.20
1 Special Radio Frequency Transformer.....	3.50	1 0-10 Jewel Voltmeter.....	7.50
1 Set of Matched Haynes-Griffin Intermediate Wave Transformers.....	20.00	1 7x18 inch Bakelite Panel, drilled and engraved.....	5.25
1 Type H-G 2 Input Condenser.....	1.75	1 Cutler-Hammer A Battery Switch.....	.60
		1 1 meg. Haynes-Griffin Resistance.....	.50
		1 Haynes-Griffin Single Circuit Jack.....	.50
		1 Marco Single Pole Double Throw Switch.....	.70
		1 Wood Baseboard, 17 x 9½ inches.....	.75

Parcel post prepaid except on C. O. D. shipments

HAYNES-GRIFFIN RADIO SERVICE, Inc.

250 West 49th Street, New York City Mail Order Departments 111 South Clark Street, Chicago, Ill.

The Tag

Bears the Proof of Uniformity

It remained for SILVER-MARSHALL to produce long-wave transformers so uniform that the amplification curve of each instrument could be plotted in the S-M laboratory, recorded directly on a tag, and tied to the transformer. The curve supplies you with the data you must have in building your super.

The idea is revolutionary. It establishes a standard of excellence that every progressive manufacturer will be forced to adopt. It again demonstrates the fact that S-M engineering methods are always a year ahead.

The "Why" of Silver Supers

Send for the "Why" of Silver Supers. It contains a complete account of the Seven-tube Dry-cell set that gives consistent sea to sea reception with speaker volume on a small loop. To the many articles which have appeared in leading radio journals, describing the Silver Super, is added another in the March issue of *Radio Age*. Look for it.



THE FOUR-TUBE KNOCKOUT

It was designed for the man who wants a simpler set, and will give super-het results on a seventy-foot antenna, when constructed with parts specified by McMurdo Silver. Literature on this remarkable receiver will be sent upon request.

Silver-Marshall, Inc.

RADIO EQUIPMENT

110 So. Wabash Ave. Dept. B. CHICAGO

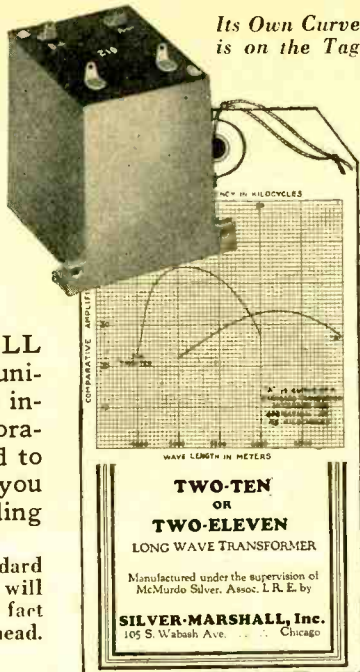

S-M Long Wave Transformers

Supplied in sets of two, or three TWO-TENS (iron-core inter-stage) and one TWO-ELEVEN (air-core filter for input or output) with identical peaks and separate curves. Price, either type (each) \$8.00. Write for circulars.

S-M Low Loss Inductances

Write for circulars on the original S-M Low Loss R. F. Coupler and Antenna Coil. Designed by Mr. Silver in accordance with principles established by the noted authority, Dr. Pickard, they show lower losses than any coils obtainable. Although originally brought out for use in the Knockout Set, they are suitable for tuned R. F., three-circuit, and other sets.

Reprints of Best's New Super---25c

PORTABLE RECEIVER

Continued from Page 16

the fact that they permit the R. F. current to cross these windings easily.

The Try-Out

OMIT condensers C_1 to C_4 in the first wiring job. Bell wire is suggested for the connections inasmuch as it is fairly flexible, well insulated and easy to alter if need be. Lamp cord is used for connections that require bending when tubes and batteries are inserted. When you first connect up the set you haven't an efficient radio frequency amplifier and the first attention is to the 3-stage audio amplifier. You probably are already familiar with the fact that there is almost always a "howl" noticed when a 3-step audio amplifier is first hooked up. This is due to regeneration or inter-action between stages through high transformer coupling and tube coupling. It is overcome by reversing polarity at one of the stages, usually the first or second. To do this, merely interchange the "P" and "B" connections to the primary winding of either the first or the second transformer. This audio trouble must be stopped before the radio frequency part will function.

Next try reception, preferably at a time when a strong nearby station is on the air. The signal will probably be quite faint, even with the loop in the optimum position. Then connect a .00025 mfd. fixed condenser in at C_4 and the same size at C_3 . Volume should then be satisfactory. Next turn the set around so that the loop is at right angles to the station's direction. Tune carefully with the variable condenser and note whether adjustment of the potentiometer results in an increase of sensitivity. It is not possible to heterodyne the incoming signal because of the resulting "squawk" set up in the amplifier by overloading. Hence you cannot approach the oscillating point too closely or a howl will commence.

The loop connections should be reversed, as results are always better with them in a certain direction. This is due to some slight inter-action between the loop and the receiver. Also try reversing the phone unit connections for improvement of tone, using loud music, preferably, for this adjustment. Should volume be lacking with the loop pointing toward the station and sensitiveness be absent when it is at right angles, increase C_4 to .0005 mfd. or at the most to .001. Beyond this, try .00025 mfd. condensers, first at C_1 , then at C_2 and finally at both. Consistent with sensitivity, the by-pass condensers should be kept low in capacity and not used unless necessary, because condensers used across audio transformers to excess result in deadened, dull quality of tone. Hence the adjustment must be a compromise between good quality from local stations and good sensitivity for stations 100 miles or so distant.

THE HIGH QUALITY — LOW PRICE

The CLARITRON \$2.30

TUBE BY MAIL

Our Type 499 Detector and Amplifier

Our Type 501A Tipless Detector and Amplifier

NOT CHEAP TUBES, BUT GOOD TUBES WHICH WE SELL CHEAPLY
You cannot get a better tube at any price—and why pay more? Our Price is low because we sell direct and are content with a fair profit. We guarantee that CLARITRON TUBES measure up to the highest standards. They will give you complete satisfaction or we will. The well known New York Testing Laboratories declared CLARITRON to be better than standard tubes selling for \$4.00. We make all kinds of tubes including:
Our No. 501A—for same use as 201A. Our No. 112—for same use as WD12. Our No. 499—for same use as 199. \$2.30 for any type. We ship all orders as soon as received. Shipments made by Parcel Post, C. O. D., or Prepaid on Receipt of Express or Postal Money Order.

SUPERIOR RADIO COMPANY, Dept. 205
176 Shephard Ave. Newark, N. J.

CHEMICAL CODE RECORDER

Continued from Page 20

to the top will serve nicely. It is also necessary to arrange one disc of the feed reel so that it may be conveniently removed for replacements. To do this, the writer turned down a brass shaft and provided it with a thread and a winged nut which was used to hold the disc in place while the device was in use. Other experimenters may devise a more ingenious method if they do not have the facilities for metal turning.

The pick-up reel may be permanently mounted, for the used tape can be very easily unrolled and stored away for future reference. However, the pick-up must be provided with a handle for turning. This is accomplished by soldering a small piece of brass to the shaft and providing it with the cork of an ink bottle. The latter can be attached with the aid of a brass machine screw about 8-32 size.

While on the subject of the pick-up reel, it might be well to suggest that there is nothing in the wide world to prevent a builder from scheming out a motor drive for this dingbat. A worm on a toy motor shaft and a smaller gear on the shaft of the reel would be nothing less than the now proverbial cat's nighty. A small rheostat in series with the motor could adjust the thing to meet the sending fist of the whole range of ham operators.

On some dark night, the family party will have to be relieved of two cocoa tins of the same size. Of course any tin can of the required shape and size will do. Cocoa tins are simple among the possibilities.

If the cocoa tins are used, it will be necessary to cut them off about half length. If a neat job is required it is not advisable to butcher them in half with a pair of snips. A little patience and a three-cornered file is the safe and sane way although it may not appeal to those who like to get an idea one hour and have it working the next.

The cocoa tins, after they are cut down, must be provided with small brass lugs soldered to their sides as shown. The four upper lugs are to carry the fibre rollers over which the tape passes on its way from the feed to the pick-up reel. The lugs are provided with small bearing holes that may be put in with a prick-punch. Ordinary pins may be used to hold the fibre rollers to the bearing—that is, the pin is driven into the fibre rod and forms the actual shaft. If fibre is not available in this size and shape, small wooden dowls boiled in paraffin will make splendid substitutes.

The small brass lugs soldered to the lower portion of the tins, are also drilled with a hole large enough to pass a half inch around head wood screw. The lugs (two on each tin) are bent at right angles and are held to the base boards by the small wood screws just mentioned.

BURGESS BATTERIES

Contribute to
a Radio Miracle



President Coolidge

H.R.H. The Prince of Wales



The transmitter that sent photos by radio from London to New York. Batteries for energizing the tubes are shown in the lower shelves of the cabinet.



General view obtained through courtesy of the Radio Corporation of America. Captain Richard Ranger of the R. C. A., inventor of the apparatus, is seen placing film upon drum of transmitter. U & U Photos

THAT Burgess Radio Batteries were chosen for this inspiring achievement is a pleasing indication of the confidence placed in them by experienced radio engineers.

Ask Any Radio Engineer

BURGESS BATTERY COMPANY
Engineers DRY BATTERIES Manufacturers
Flashlight - Radio - Ignition - Telephone
General Sales Office: Harris Trust Bldg., Chicago
Laboratories and Works: Madison, Wis.
In Canada: Niagara Falls and Winnipeg

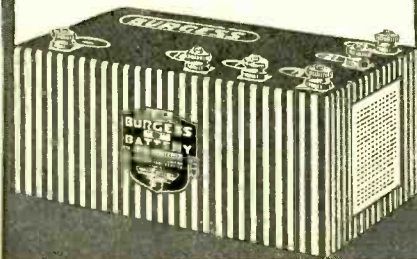

When your set is equipped with Supertran audio transformers you are assured faithfulness in reproduction, clarity, and freedom from all distortion. The Supertran being shielded, is protected against damage to the coil while mounting.

3 1/2 TO 1—5 TO 1 RATIOS

\$5 At Good Dealers
Everywhere

Distributed by

Philip Chandler & Co. Providence, R. I.
Boston, Mass. The Beckley-Ralston Co.
L. W. Cleveland & Co. Chicago, Ill.
Portland, Maine Coast Radio Supply Co.
Gray Sales Co. San Francisco, Cal.
Philadelphia, Pa. Radio Ltd.
Waite Auto Supply Co. Montreal, Canada
FORD MICA CO., Inc., 33 E. 28th Street, New York



REGISTERED U.S. PATENT OFFICE

AUDIO TRANSFORMER

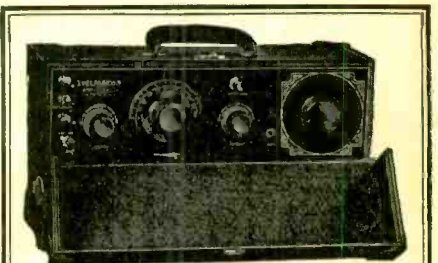

The Famous Truly Portable
TELMACO P-1 Receiver

Four Tubes Do the Work of 7

Coast-to-coast reception. Aerial, loud speaker, and batteries self-contained. Carry from room to room—take it anywhere. Size 8" x 10" x 18". Total weight only 26 lbs. Complete with tubes and batteries. \$125.00 \$147.50. Receiver only

P-1 Kit Saves You Money!

In response to a popular demand we now offer the Telmac P-1 Receiver in kit form. This contains all parts, as built by us, including case, drilled and engraved panel, and illustrated instructions. \$80.00 Complete kit

Ask your dealer or write us. Descriptive folder free.

Radio Division:

Telephone Maintenance Co.
20 So. Wells St. Dept. A, Chicago, Ill.



Quality Radio Exclusively Established 1918

Why not subscribe to
"RADIO" for 6 months?

Price \$1.00



\$60 *Every Man's Receiver*

Here's a five-tube tuned radio frequency receiver that deserves the earnest consideration of the man who wants results in radio reception. Volume results! Range results! Satisfaction in every detail! At a price that makes the Marwol give more real radio value for your dollar than any other set on the market today. Before you purchase a set at any price, compare it with the Marwol point for point and part for part. You will then know the superiority of details that makes the Marwol today's best radio buy for the money.

MARWOL HOME BUILDER

outfit contains parts for the construction of a Marwol 5-tube tuned radio frequency receiver. Like the Marwol set, The Marwol home builder gives you the best value obtainable for the man who prefers to construct his own set. Retail for \$15.

MARWOL RADIO CORP.
85L Mercer St., New York City

MARWOL
Tuned
Radio Frequency

This finishes the tins, with the exception of giving the insides a coating of paraffin to prevent rust when they are filled with the water and the potassium iodide solution. The outsides may be painted with egg-shell black or some other mixture that will resist the chemical used.

The standard carrying the actual recording member is cut from the same stock used in the construction of the reel standards. The detail of this is shown at the top of the drawing. A hard rubber or bakelite block is held to the piece by a single screw, the block being tapped out to receive it. A guide piece bent to shape from very thin sheet brass must also be made and soldered to the portion of the standard that is bent horizontal at the top. A little attention to the sketch will also make the construction of this particular member clear to those who wish to construct the device. The only precaution is that of seeing to it that the tape is allowed to pass freely and without breaking.

It is evident that the recorder can not be operated without the use of a sufficiently sensitive relay. Still this does not need to be an obstacle to the resourceful experimenter. Who deserves to be called a ham that can not assemble a simple little relay from a discarded telephone receiver? It is hoped that the mere suggestion will be sufficient.

The solution is made by dissolving the potassium iodide crystals in luke warm water. It will be found that about one ounce of the crystals will make about one pint of the solution. The tin containing the solution is placed in front of the feed reel so that the tape will be moistened with it before it reaches the actual recorder. When it does reach this member, two small silver or platinum wires with rounded ends are allowed to come in contact with it. Since these wires are connected to the positive and negative poles of a single, dry cell, current will pass through the liquid on the tape every time the relay closes the circuit. A few trials will permit the builder to determine the best position for the wires. A separation of about a thirty-second of an inch will be about right.

It will be seen that the container carrying the water is simply for the purpose of rinsing off the tape before it is picked up.

Larger storage battery tubes can be used instead of the dry battery tubes specified in the Best 45,000 cycle super-heterodyne if care is used in shielding the set. Both the panel and the inside of the cabinet should be shielded with thin sheet brass or copper. A metal partition should be placed so that the oscillator tube, coupler and condenser are shielded from the rest of the set. All shields should be connected to the negative *A* battery.

Ware
NEUTRODYNE
Receivers

Type T
\$65.00
Without
Accessories

WARE RADIO CORPORATION, N. Y. C.

IXL RADIO CRYSTALS

The most sensitive long distance Radio Crystal known. Alive all over, no dead spots. Price 50 Cents

U. C. BATTERY AND ELECTRIC CO.
2158 University Ave., Berkeley, Calif.

\$1.00 Brings You "RADIO"
for Six Months. Subscribe Right
Now!

"AIR ROAMER"

A McCall Compensated Circuit set, simple to operate, extremely selective, giving true tones, rugged and economical. Write for details.

KILBOURNE & CLARK MFG. CO.
Seattle, Washington

Branches: Portland, Ore.; Los Angeles; San Francisco. Distributors: Pacific Electrical Company, Sydney, Australia.

Volume and Clarity

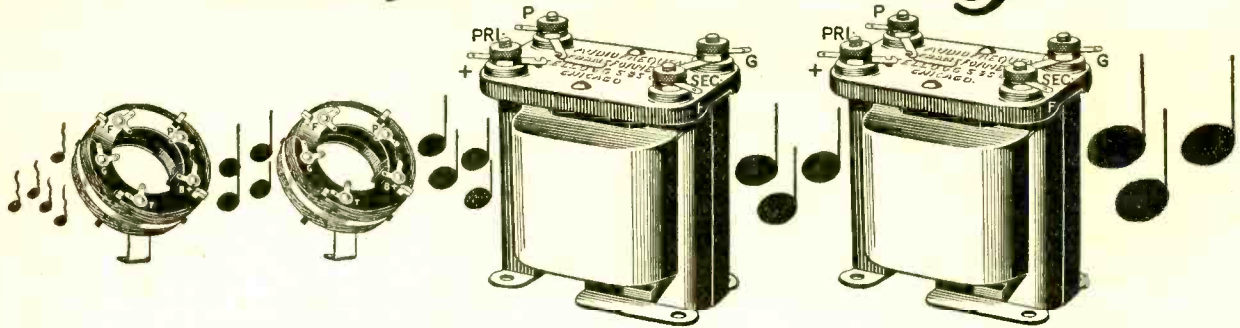

with Kellogg Transformers

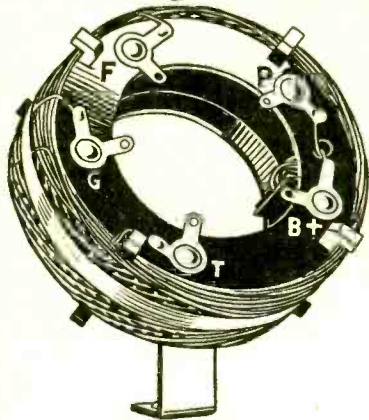

Radio Frequency Transformer

A Radio Frequency Transformer of the aperiodic type suitable for all sets with which tuned radio frequency is desired. Also used for one stage of radio frequency amplification ahead of regenerative sets to prevent re-radiation.

Consider these points of superiority:

- No dope to hold windings in place.
- Soldered connections.
- Mounting bracket holds coil at correct angle.
- Minimum rubber used in form.
- Lowest possible loss, with greatest transfer of energy.
- Works with any .0005 condenser.
- Secondary arranged with suitable taps for biasing features.

This transformer makes the construction of a radio frequency set an easy matter, assuring best possible reception with widely varying types of circuits, including reflex.

Built and guaranteed by Kellogg Switchboard and Supply Co.

No. 602 Radio Frequency Transformer
at your dealers for \$2.35 each.

Kellogg Audio Frequency Transformers are the "stepping stones" of modern amplification.

Clear, accurate reproduction assured over the entire range of the musical scale.

Plainly marked, accessible terminals.

It is acclaimed by test to be the best.

No. 501 Audio Frequency Transformer
Ratio $4\frac{1}{2}$ to 1—

No. 502 Audio Frequency Transformer
Ratio 3 to 1—

\$4.50 each

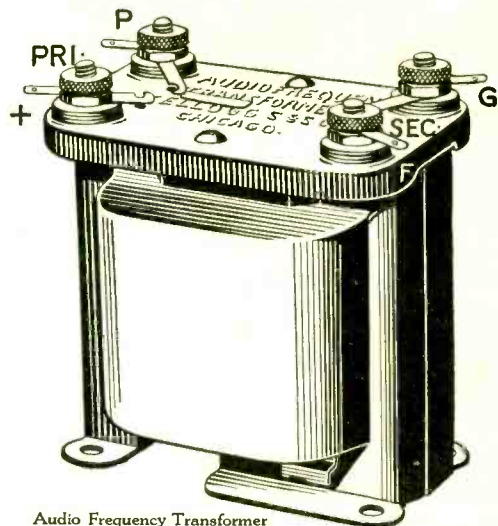

Audio Frequency Transformer

KELLOGG SWITCHBOARD & SUPPLY CO.

1066 WEST ADAMS STREET, CHICAGO

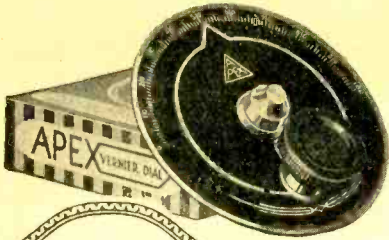

MORE DISTANT STATIONS

WITH THE **APEX** VERNIER DIAL

Greater range, bigger volume, finer selectivity, less interference. Lasts forever. The one big advance yet made in tuning. Ratio 12 to 1.

Quickly applied to any shaft.

For sale by all good Radio Dealers.

If unable to obtain from dealer, enclose

\$2.00 for Royal Brass Finish.

\$2.50 for Satin Silver Finish.

\$3.50 for De Luxe Gold Plated Finish.

The Apex Super Five

is a tuned radio frequency receiver of the highest type. Built into a highly finished walnut cabinet—complete with Jones Multiple Battery Cable—all settings highly gold plated. List price \$95.00 complete.

7 Tube Microdyne Super-Heterodyne for \$97.50
 Receive the parts complete to assemble your set. Coast to coast on an 18 in. loop. Assemble this 7-tube Microdyne Super-Heterodyne on a 7 x 18 in. panel in 3 hours. Parts complete. Price of cabinet, to fit, on application. If your radio dealer cannot supply, send check or money order and name of dealer.

Apex Electric Mfg. Co.

1410 West 59th Street, Dept. 310, Chicago

Send for Trial Subscription
 \$1.00 for Six Months

New LeFAX RADIO HANDBOOK—\$2.00

(Seventh Edition)

in bound form. For sale by "RADIO," San Francisco

"Built First- **Coto** -to Last"

INSIST ON THE SILVER PLATED AIR CONDENSER FOR YOUR RADIO SET.



HONEYCOMB COILS

The Universal all-wave inductance. Back and front panel mountings. Send 25c for Super Het., R. F. and Honeycomb Coil Circuits and Complete Catalog.

Chas. A. Branston, Inc.
 815 MAIN ST. BUFFALO, N. Y.
 DEPT. 12

When the phone rings

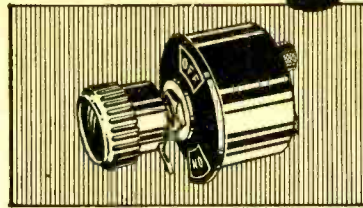

**Snap ~ AND ALL IS SILENT
 Snap again ~ AND THE PROGRAM CONTINUES ~ without retuning**

No modern set lacks the convenience of a MAR-CO filament battery throw switch. Its definite on and off positions make it far superior to any pull switch. Saves tubes and batteries—you don't forget to turn them off! Saves annoying interruptions when you only want to stop reception for a minute!

Make your set convenient with a **MAR-CO**

ON AND OFF BATTERY SWITCH \$1.00

SEND NO MONEY!

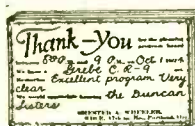

YOUR OWN Name and Address Printed Free on Thank You Cards Hear what YOU like. Stations are glad to put on numbers at your request. We print Special cards that get ATTENTION. All the RAGE. Cards Printing FREE! 100—only \$1.35; 200—\$1.85; 300—\$2.35, plus few cents postage. Order TODAY.

MONEY REFUNDED If Not Delighted Quality cards. High grade printing. Send no money—just pay postman when you get cards. Order NOW! **RADIO PRINTERS, 3471 Main St., Mendota, Ill.**

BROWNIE CRYSTAL

"REFLEX SPECIAL" QUICK CONTACT RECTIFIER GUARANTEED \$1.00

The Acme Apparatus Co. says "prevent distortion and howling by using a BROWNIE CRYSTAL in Reflex Sets" Order From Your Dealer or Direct.

ROLAND BROWNIE & CO.
 24 Saunders Street, Medford, Mass.

EXPERIMENTING WITH A LOOP

Continued from Page 24

sults in a considerable increase in signal strength. This may be particularly apparent where the set is operated well above the ground level. But static, electric disturbances and interference will come in "via the ground" and the decrease in selectivity, even with the aid of a wave trap, may make the ground connection undesirable. Either side of the A battery connected to ground, may increase signal strength greatly.

There has been much written regarding "dead-end" effects in coils. That unused turns of wire certainly have an effect may be demonstrated in the case of the loop by using part of the loop only, as tuning inductance, determining the wave length, then removing the unused turns completely from the loop frame. The wave length is lowered. It is very interesting to insert a variable condenser across the "dead end" part; when the setting of the condenser is changed, the tuning of the receiver is likewise changed and an increase of condenser across the dead end means higher wave length tuning for the receiver. "Short-circuiting" the unused portions of the loop certainly has a pronounced effect. Some sets refuse to function when the portion of the loop which is unused is connected to the loop input directly connected to the grid of the first radio frequency tube socket, as in Fig. 4.

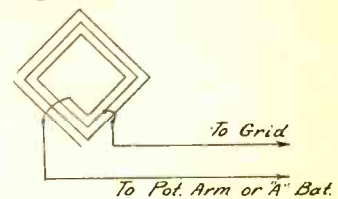

Fig. 4. Unused Turns of Short-Circuited Loop; Here Shown at Grid End, Should be at Filament End of Loop

A "straight-line wave length" variable condenser instead of the more usual "straight-line capacity" (usual semi-circular rotor plate type), gives better tuning on the low wave lengths, when shunted in the usual fashion across the loop.

A series of regeneration may be utilized in the tube circuit nearest the loop by using half of the loop as tuning inductance and the balance in the plate circuit of the tube. Note the necessity for the insertion of a condenser as indicated in Fig 5. As this means one more

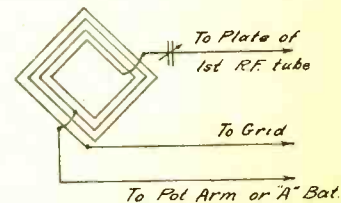

Fig. 5. Connection of Mid-Tap Loop

control, adding of regeneration may not be advantageous. As the number of turns

available in the loop for use in the plate circuit will vary with the particular loop in use, the value of the condenser shown in Fig. 5 cannot be told with accuracy. If the number of turns available be large, the condenser need perhaps be only a "Chelton Midget," but if few, a 23-plate condenser might be necessary. Different hook-ups would also affect the regeneration requirements as to turns in loop and value of condenser.

The tapped loop used by David Grimes in his inverse duplex hook-ups often is advantageous with other types of loop sets. In its simplest form this may be used as in Fig. 6. Note that the variable

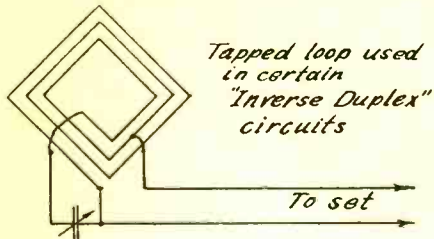

Fig. 6. Tapped Loop Used With Inverse Duplex Set

condenser shunts the whole number of turns in the loop, while only a portion of the whole inductance of the loop turns go to the set. Where strong local signals seem to "choke up" the set, this scheme may be especially beneficial.

To gain additional selectivity, a wave trap may be often used to advantage with a loop. This may consist of another loop placed close to the loop used in tuning the set, with its terminals shunted by a variable condenser of about .0005 mfd. capacity. The trap is operated in the same manner as that next described. The trap loop should be placed, if possible, between interfering station and loop used for tuning, rather than on the side of tuning loop away from the interfering station.

The wave trap may also be of the usual inductively coupled type, consisting of about 55 turns of about No. 22 DCC magnet wire wound on a 3-inch tube, shunted by a .0005 mfd. variable condenser. At one end of the 55 turns, 15 turns tapped at, say, 5, 10 and 15 turns, are then wound over the first layer. The 55 turns then constitute a "tuned" secondary and the tapped 15 turns a "semi-fixed" primary. The "trap" works to "absorb" an unwanted signal. The primary is connected in the loop circuit between the loop and the terminal of the set which does not connect to the grid of the first R. F. tube. Fig. 7. The

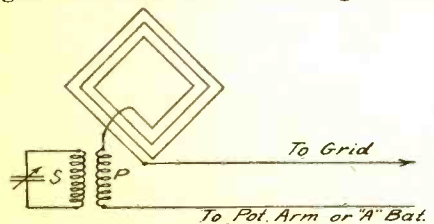
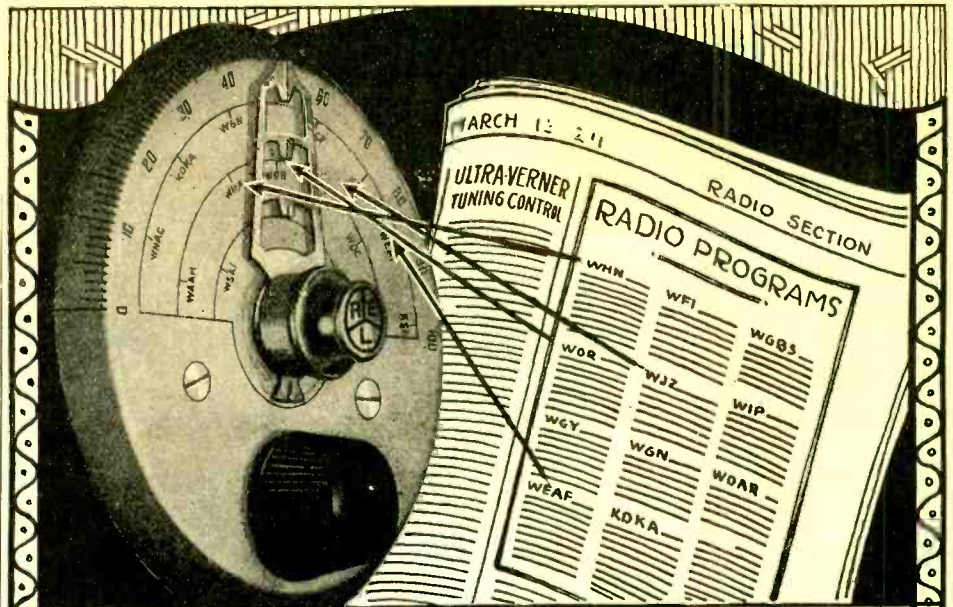

Fig. 7. Wave Trap with Loop set is tuned (with the trap condenser at



Tune by Sight



Designed by R. E. Lacault, E. E., A. M. I. R. E., inventor of the famous Ultradyne circuit. This monogram seal (R. E. L.) is your assurance of Lacault design.

Tune your favorite stations once, mark them on the Ultra-Vernier, then forget wave lengths. Tedious tuning, blind fumbling and guessing are over for all time.

\$2.50

Now it's possible to pick your entertainment from the radio program and turn the dial instantly, accurately, to your station and know your receiver is tuned with infinite precision.

The Silvered Ultra-Vernier dial mounts fast to panel. Single control 20-1 ratio, operates vernier for hair-splitting adjustment and governs station indicator. Replace your old dials with Ultra-Verniers. You've never known such tuning ease.

Write for Descriptive Circular

Made by the Hammarlund Mfg. Co., your assurance of quality and dependability—produced solely for the Phenix Radio Corporation. At your dealer, otherwise send purchase price and you will be supplied postpaid.

ULTRA-VERNIER TUNING CONTROL

PHENIX RADIO CORPORATION
9 Beekman Street New York City

Pacific Coast Representatives:

CARL A. STONE CO.

644 New Call Building, San Francisco, Calif.

1116 Minor Avenue, Seattle, Wash.

429 Insurance Exchange Building, Los Angeles, Calif.

RADION Black and Mahogany Dials, Tubing, Sockets, Horns **PANELS** etc.

"That special size for your super, phonograph, portable or odd size cabinet."

ALL STOCK SIZES
WHOLESALE RETAIL

Send for Price List

SPECIAL HARD RUBBER PARTS
MADE TO ORDER

New York Hard Rubber
Turning Co.

212C Centre Street New York

Hook-Ups!

Hook-Ups!

Hook-Ups!

of all circuits in RADIO WORLD

The First Illustrated Radio Weekly

Other Great Features:

Wonderful Question and Answer Department; latest developments in radio art and science; human interest and technical pictures; helps for novice and expert; articles by the best authorities. Full of meat from cover to cover. 15c per copy, \$6.00 yearly (52 issues); \$3.00 six months; \$1.50 three months.

Special: \$1.00 for ten issues.

RADIO WORLD

1439 Broadway

NEW YORK

PENNSYLVANIA

RADIO PRODUCTS

EVERY item bearing the "Pennsylvania" trade mark is absolutely guaranteed to satisfy. The dealer is authorized to refund the purchase price for any item which does not satisfy. These products formerly sold at two times the present prices. Quantity production has made these low prices possible. The quality is the same. Our slogan is — WE DARE YOU TO BEAT THEM AT THE PRICE.



List Price, Type E-25, \$3.50

PENNSYLVANIA HEAD-SETS

are ideal for both professional and amateur use. They are highly sensitive, with a magnetic circuit that is carefully designed to insure permanent efficiency. The excellent tone of the "Pennsylvania" surpasses phones of much higher prices. A one year written guarantee in every box. When better phones are designed you will find PENNSYLVANIA'S at the top of the list.

PENNSYLVANIA LOUD SPEAKERS

A beautiful fitment for the home, rendering the most perfect reproduction.

Truly the Finest Speaker Ever Offered at Such a Popular Price.

Volume!
Clarity!

Takes High Voltage without distortion.

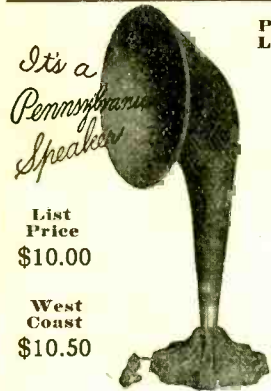

List Price
\$10.00

West Coast
\$10.50

Write For Our Attractive Proposition

HAMBURG BROTHERS

624 Grant Street

Pittsburgh, Pa.

POLY PLUG

75¢

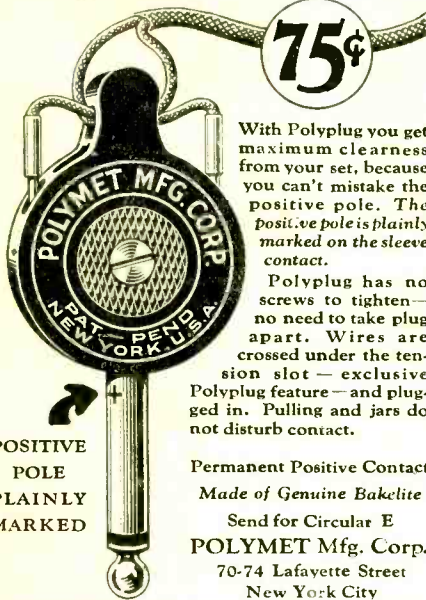

With Polyplug you get maximum clearness from your set, because you can't mistake the positive pole. The positive pole is plainly marked on the sleeve contact.

Polyplug has no screws to tighten—no need to take plug apart. Wires are crossed under the tension slot—exclusive Polyplug feature—and plugged in. Pulling and jars do not disturb contact.

Permanent Positive Contact
Made of Genuine Bakelite
Send for Circular E
POLYMET Mfg. Corp.
70-74 Lafayette Street
New York City



Price
\$1.10

"Each LEAD-IN WIRE shall be provided with an approved protective device—"
The Jewell Lightning Arrester has passed the tests and has been approved by the Underwriters for indoor and outdoor installations.

Order from Dealer

Jewell Electrical Instrument Co.

1650 Walnut St. - Chicago

SEE BIG OFFER ON PAGE 55

A FEW COPIES LEFT

JANUARY
"RADIO"
25c

We have only a very limited number of copies of January "RADIO," containing the complete details for building BEST'S NEW SUPER-HETERODYNE.

ORDER NOW

PACIFIC RADIO PUB. CO., San Francisco

zero) until the interfering signal is loudest and then the trap condenser is turned until the interfering signal is weakest.

The wave trap used with a loop is not a "Close Sesame" to the interfering signal but will certainly help eliminate bad interference. The real selectivity gained by the use of the loop is in its ability to receive stations lying in its plane with greatest volume and in its "turning a deaf ear" to stations lying at right angles to its plane.

A bit of parting advice to users of sets which have small loops incorporated in the set or who use loops wound on sticks less than 3 feet long: the pick-up ability and consequent volume of signals will be greatly increased by increasing the size of the loop to 3 feet or preferably even larger. The large loop may mean the difference between headphone and loud-speaker volume.

QUERIES AND REPLIES

Continued from Page 40

tube. If you wish to use a storage battery tube, you will have to increase the voltage to 6 volts, and change the sockets to accommodate the larger tubes.

I have three 45 volt B batteries on my Fada Neutrodyne. I get KDKA and WGY very clear, and sometimes quite loud. Would more or less B batteries improve the operation of the set?—Mrs. S. C. H., Roseville, Calif.

One hundred and thirty-five volts on the plates of UV-201-A tubes, without C batteries means short lived tubes, and we would recommend a reduction in plate voltage to 90 volts if you expect to get any sort of life out of the vacuum tubes. For 135 volts on the plates, a C battery of 9 volts should be placed in the grid circuits of the audio frequency tubes, at least.

Can I use an antenna coupler with a fixed antenna coil, in the Improved 45,000 cycle super-heterodyne described in January RADIO?—I. M. F., Little Falls, N. J.

Such a coil would not be selective, and a great deal of unnecessary interference would be introduced into the set. The antenna tuner described in January RADIO is the most satisfactory for use with the receiver, and at any rate, the antenna coil should be made variable with respect to the secondary coil.

"Elements of Radio Communication"

By Lieut. E. W. Stone

\$2.50 A Book that every radio fan should have.

SENT POSTPAID ANYWHERE

PACIFIC RADIO PUB. CO.

Pacific Bldg. San Francisco

RADIO GLOSSARY

Revised and Glossed

By Jack Bront

HARMONICS: Side-door Pullman emissions from wave trains.

CRYSTAL DETECTOR: Amusement device, employing time of listeners in adjusting and procuring cat's mustachios.

MODULATION: System of splitting C. W. up into chunks so it sounds like a dog fight.

SELECTIVITY: Attribute of single circuit receivers which excludes all signals except those from all over the universe.

STATIC: Try and find out.

TUNING: A deliberately acquired habit of twisting the knobs off a delicate instrument in order to hear static at a distance.

RECTIFIER, CHEMICAL: Efficient form of heater which exudes borax solution all over carpets and rugs.

RADIATION: A measure of the maddening discord in the antenna.

PLUG: Affectionate term applied to a fellow who loans you a tube. Variations: good plug, old horse, etc.

DECREMENT: Rapidity with which senile currents lay dawn and die with their boots on.

AMPLIFIER: Specially constructed device, to bellow like a bull at audio,—and squeal like a Chink at radio freq.

ANNOUNCER: Individual specially trained to masticate the English language.

ARMSTRONG CIRCUIT: One operated by hand in which inductances are "tapped" and "beat" notes produced.

BROADCASTING: The art of afflicting listeners with howling dervishes at a distance.

ELECTRONS: Electric charges better heard than seen.

GROUND: Place where holes are found by digging—used to plant antenna crops.

HENRY: Manufacture of that indispensable radio accessory—the Ford coil.

FREQUENCY: Feminine trait of currents to change their minds.

JACK: See below.

KICK-BACK: See above.

IMPEDANCE: Speed traps for joy-riding currents.

LOG: Amusing book of fairy tales enumerating "Stations worked."

MEGOHM: Contraction of Scandinavian expression: "Me go by the house in."

MICROPHONE: Applied at howling dervish camps to attack listeners at a distance.

OHM'S LAW: Edict making a college yell compulsory at engineering schools: (Cross-word puzzle form)

R E I !

E I R !

I R E !

PLATE: Device in radio reception,—impinges on head of hubby B. C. L.'s who refuse to go to bed.

No bulbs to buy
No acids-No fumes

THE SILENT
FRANCE
MULTI-DUTY
SUPER-CHARGER

No sticking or
sparking contacts

UP TO
120
VOLTS
IN
SERIES



No more troublesome wire changing! Just connect the charger clips to the battery terminals and turn on the current—simple, quick and convenient. The France Super-Charger not only charges 120 volts of B battery in series, but it also charges 2, 4, 6 or 8 volt A or Auto batteries, at a 5 to 7 ampere rate, tapering as the battery is charged.

Silent and non-critical in adjustment, the France Super-Charger is the ideal charger for home use. Price of Super-Charger, West of the Rockies, \$23.00.

DEALERS AND JOBBERS—This advertising is creating a large demand in your territory. Write us today for sales proposition.

THE FRANCE MFG. CO.

10323 Berea Rd. Cleveland, Ohio

PACIFIC COAST BRANCHES:

LEE H. CRAIG CO. NORMAN COWAN CO.
75 Fremont St. 53 Fourth St.
San Francisco, Calif. Portland Oregon

"INSULATE"
(Molded Composition)
(Registered Trademark)

Articles of Any Shape
Molded to Order

"HI-HEET"
(Bakelite)

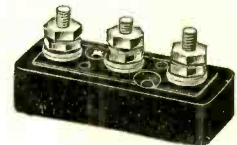
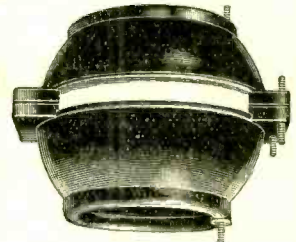
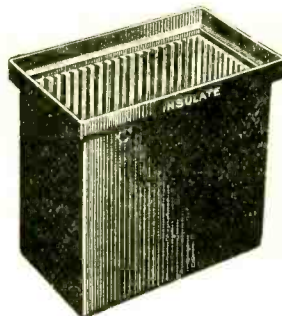

100 (Knobs, Dials,
Binding Posts,
Head Caps,
Insulators, Etc.)
STYLE in stock for prompt shipment

Insist on "HI-HEET"
or "INSULATE" from
your dealer

GENERAL INSULATE CO.

999 Atlantic Ave., Brooklyn, N. Y.

Established 1904

Elements of Radio Communication

By Lieut. E. W. Stone

A Book that every radio fan
should have.

\$2.50

SENT POSTPAID ANYWHERE
PACIFIC RADIO PUB. CO.
Pacific Bldg., San Francisco

MATHISON'S POLAR CRYSTAL

Mined North of the Arctic Circle
Gives sharper tuning, more volume
and longer life. A solid, sparkling
silver ore, not "doped" or coated.
The most sensitive radio crystal in
the world. A postal card brings you
one. Price each.....85c

MATHISON SILVER ORES CO.
OF ALASKA

American Agents

Radio Owners Service Co.
660 Twelfth Street, Oakland, Calif.

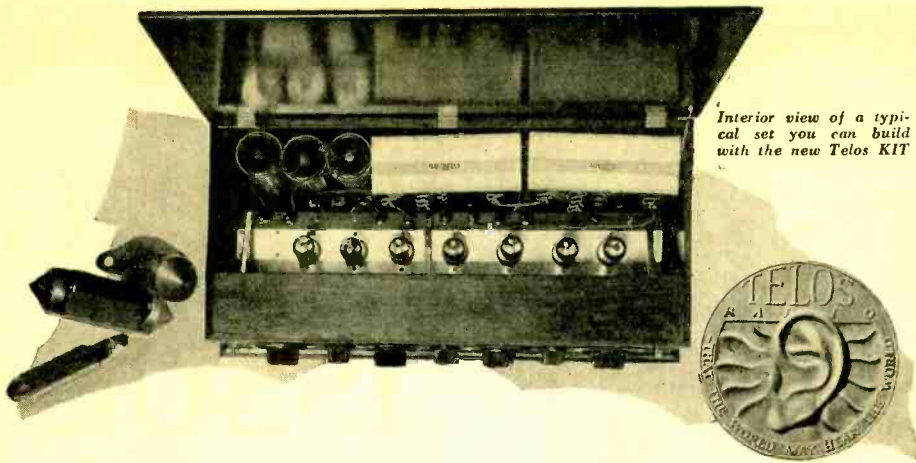

Interior view of a typical set you can build with the new Telos KIT

You can't buy it —

*but if you are the least bit handy with tools,
you can build this amazing Telos
set yourself in a single afternoon*



The basic goodness of Telos design is the same as it has been for three years. But now, Telos excellence has been extended to include *three* stages of tuned R. F. and super-imposed (reflexed) resistance-coupled A. F. as well. The new Telos KIT opens up a world of fascinating possibilities in radio. As in the photo above, you can build a 5, 6 or 7 tube set, and run it all on dry cells! It will cost you less to run than any other set of like power!

You can introduce a crystal detector if desired! You can use

transformer A. F. if you prefer. But no matter what combination you select, you will find clear, unmistakable instructions in the book, that comes with every Telos KIT, and you will accomplish results you never thought possible before!

Fill out the coupon now. Get your copy of the new, generously illustrated booklet, "The KIT of a Thousand Possibilities." It's free, but the edition is limited to those who are genuinely interested in superlative radio reception!

Telos Radio

Danziger-Jones, Inc.,
Dept. R, 25 Waverly Place,
New York, N. Y.

Send me at once your booklet "The KIT of a Thousand Possibilities."

Name

Address

RADIO GLOSSARY

Continued from Page 75

PLATE CIRCUIT: Trajectory of plate before impinging, as above.

PLATE BATTERY: Pantry shelves stocked with above plates.

RADIOGRAM: Radio message. Also hodge-podge of "Dear Willie 9xPBF, Our cat has kittens, love, Jimmy," worth its weight in poison to anyone but a deep-dyed ham.

RELAY, RADIO: Efficient device operating a local circuit. (Try and get it.)

SPECIFIC GRAVITY: Facial expression when the ten-watter blows up.

SPAGHETTI: TUBING: Used in some sets to hide iron wire connections and bum joints.

SOFT TUBE: Duct in brain of radio enthusiasts,—also in non-enthusiasts.

VACUUM TUBE: Deceitful device enclosed with glass intended to be burned out through short circuits.

WATT: Measure of tube input until tube is thoroughly fused,—result then called: "Ohwhatamess."

SLIDER: Temporary occupation of a ham sliding off a roof.

SHARP TUNING: Attribute of condensers with Gillette plates.

RADIO LINK: (Missing link): Undiscovered connection between a good receiver and a price of \$8743.00.

RHEOSTAT: Device designed to get all "het" up over its work.

OSCILLATIONS: Mischievous pranks of young and giddy currents.

POTENTIAL: State or condition of a circuit discovered by placing a finger on each wire.

HOOK-UP: Menial task assigned by wives to husbands who since adapted it to radio.

E. M. F.: Contraction of Umf! or Umph! meaning "Here I come."

ARC: Harmonic factory,—a hot sketch.

ATMOSPHERICS: Gaseous emissions at club meetings.

CHOKER COIL: Invented by great orator, Patrick Henry; used to keep audience in submission.

AMMETER: Arbitrary device which always "lies" in the antenna.

ETHER: Hard, soft, thick, thin, substance which is rigid, flexible and stiff—any one of either.

STORAGE BATTERY: Device designed to leak acid in small dribbles (quart) on polished floors and on carpets.

VOLT: Discovered by famous French baseball player, Voltaire, while visiting the Monmartre.



**SPRING
ISSUE
NOW
READY**

Every Radio Fan Should Have a Copy of This Wonderful Book!

Contains a complete and up-to-date list of all Radiocast stations throughout the world, giving call letters, new wave lengths, class, slogan, schedules and time these schedules are based on. Four large maps, distance chart and log sheets.

Shows how to build: Superheterodyne Reflexed, Four Tube Knockout, Altrodyne, Three Tube Reflex, Greene Concert Selector, New "D" coil Five Tube Reflex, Deresna-

dyne, Eight Tube Super Heterodyne. All the latest circuits are shown in graphic and schematic form.

Worth five dollars of any fan's money. On sale at your favorite radio store and all newsstands for only—50 cents per copy.

Amateur calls all over the world, U. S. Commercial stations and foreign high power stations sold in complete book, all under one cover, for—75 cents.

Jobbers and dealers, write for our guaranteed plan of sale.

PUBLISHED SEMI-ANNUALLY

by

CITIZENS RADIO SERVICE BUREAU, Inc.

508 SO. DEARBORN ST.

:-:

CHICAGO, ILLINOIS

Tell them that you saw it in RADIO

77

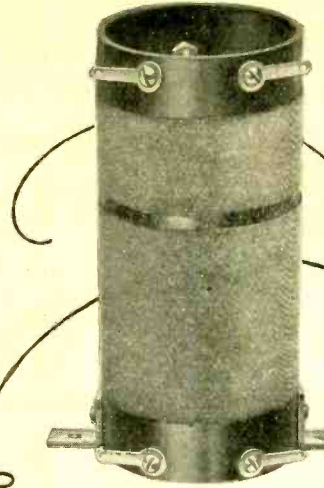

**PRECISION
AUTODYNE
COUPLER**

Again Precision leads! L. M. Cockaday specified in the January issue of Popular Radio the new Precision Autodyne Coupler for his 8-tube Super-Heterodyne Reflex Receiver.

The Autodyne Coupler is a new development for use in connection with a vacuum tube for producing a continuously variable alternate current. Used as a laboratory vacuum tube oscillator, the frequency of which may be calibrated and thus the apparatus used as a standard, also as an oscillator and detector in some of the more specialized forms of the Super-Heterodyne.

At your dealers—otherwise send purchase price and you will be supplied postpaid. Made by the makers of the genuine "Cockaday" Coil.

Precision Coil Company
209-C Center St. New York City

\$3.50

Minnesota Man Claims 2-Tube Reception Record with Lopez Low-Loss Tuner

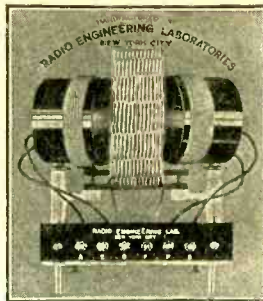

"Edward C. Connelly of Breckenridge, Minn., claims the greatest reception record in the Northwest during International Radio week with a two-tube set. His reception record is as follows: Madrid, Aberdeen, Birmingham, Lyons, Newcastle, Rome and stations in Porto Rico and Mexico City. Mr. Connelly assembled the set himself." (Reprint from Minneapolis Tribune.)

As he used dry cell tubes, which give about 75% of the signal strength secured with 6 volt tubes, he attributes his record to the LOPEZ LOW-LOSS TUNER.

**Exceptionally Well Made
No Short-circuited Turns—Rugged
Minimum Insulation—Rigid Inspection
Super Selectivity**

**Broadcast Type 200 to 600 meters
Regular Amateur 40 to 205 meters**
Circuit diagrams, panel drilling templates and instructions with each tuner.

Price—\$10.00 Each

At your dealer's or sent direct postpaid

Write for literature

A. C. LOPEZ & CO.

334 Fifth Ave., Dept. R-3 New York City

IMPROVED LOOP ANTENNA

Continued from Page 25

steel. The steel tube seems to be somewhat better by test.

Constructional details are as follows:

The materials needed are a 3-ft. piece of $\frac{1}{2}$ in. iron conduit such as used for house wiring. A piece of ordinary iron pipe would do. Two blocks of wood 1 in. thick, $1\frac{1}{2}$ in. wide, and 8 in. long. About 90 feet of Litz wire will also be needed.

Remove all rough edges from the inside of each end of the conduit so there will be no danger of damaging the insulation of the wire.

Drill a hole in one end of each wood block of such a size that the block can be pressed tightly on the end of the conduit. Also cut a notch in one end of each block as shown in Fig. 4. Round the

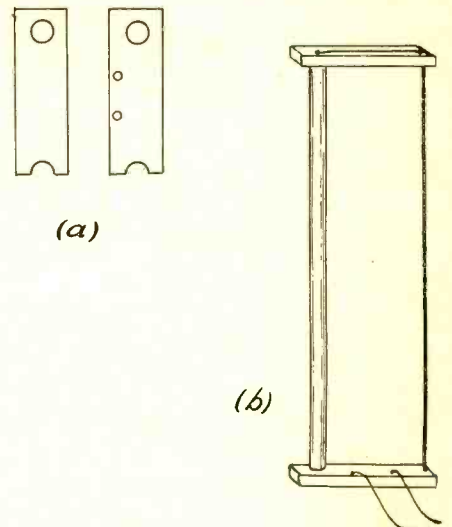

(a)

(b)

Fig. 4. Constructional Details of Single-Wire Loop

edges of this notch so the wire will not be damaged. If the constructor wishes to make a very neat job the edges may all be slightly rounded.

Two small holes should now be drilled in one of these blocks to provide a starting and an ending place for the ends of the loop. The purpose of the notches in the outer ends of the wood blocks is to cause the wires to bunch together. This seems to increase the effectiveness of the loop very materially.

The winding is rather difficult as the wire must be passed through the tube and wound tightly around the notches. A piece of heavy wire with a small eye at one end can be used to fish the Litz through the tube. The completed loop is shown in Fig. 4b. This loop operates in a vertical position. The shield should be connected to the ground for best results.

The loop shown in Fig. 5 operates on the same principle but does not require a ground. The materials required are: A strip of wood 1 in. thick by 2 in. wide. Its length is only limited by the height of the ceiling in the room in which it is to be used. In general the longer this

The Quiet NILES

Battery Charger

Deliver 72% of Currents

The Quiet Niles does a thorough job of charging—quickly and cheaply. Charging rate (8 to 10 amp.) automatically controlled. No bulbs. No liquids. No fumes. Black enamel finish. Model A for 6-volt batteries, \$19.00; Model AB for 6-volt and 24-volt batteries, \$21.00. Add \$1 west of Rockies. Write for literature.

NILES MANUFACTURING COMPANY
Dept. 73, Ypsilanti, Mich.
Coast Rep., Clark & Close,
1609 Pine St., San Francisco

RADIO CATALOG

Full of Information

100 Live Pages

Bargains

in Sets,

Parts and

Accessories—

Everything you

may need to build

or equip any set.

Satisfaction or

your money back.

Don't Delay!

Send for it TODAY!

Contains interesting explanation of marvelous benefits of Radio which you may enjoy—told in language anyone can understand. You should get it before buying.

(And will you be so kind as to add the name of one or more friends you believe will soon want radio goods? Thank you!)

Liberty M.O. House, Dept. 4674 106 Liberty St., N.Y.

CRESCENT LAVITE RESISTANCES

Absolutely non-inductive.

12,000
45,000
50,000
100,000
Ohms



LIST
\$1.50
EACH

Special resistances to order \$2.50. When better resistances are made they bear the Crescent label.
CRESCENT RADIO SUPPLY CO.
1-3-5 Liberty St., Jamaica, N. Y.

**The Powerful
GAROB
NEUTRODYNE**

Made by **The GAROB CORP.**
120 Pacific St. Newark, N. J.

RADIO LIBRARY

\$3.00

"Elements of Radio Communication" (by Stnoe)

"The Radiobuster"

RADIO MAP of U. S.
RADIO LOG BOOK

All of these for \$3.00

"RADIO" - - San Francisco

Tell them that you saw it in RADIO

strip is the better, within reason. An ordinary binding post can be used at each end to hold the wires.

No. 30 DCC wire was used in the writer's. This wire is carried back and forth between the binding posts until seven strands are wound on. The ends of each of these wires must make an electrical connection to the binding posts. The wires are allowed to bunch themselves. No. 30 wire is used for the leads to the set, only one wire of this size leading from each binding post.

The principle of operation may be understood from Fig. 5. The neutraliza-

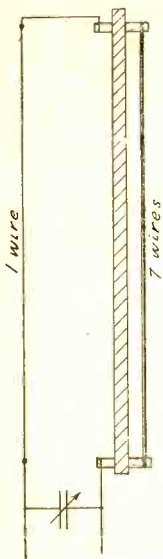

Fig. 5. Eight-Wire Loop Without Ground Wire

tion of this loop by a current induced in an opposing direction in the other side is avoided by the fact that seven wires form one side while one wire forms the other side. This gives the current induced in six wires. This loop was only used on a short wave set ranging around 150 meters. Two of the longer wave stations were received on their harmonics. WTAS was received on 143 meters and WOAW was received on 175 meters. The former station is about 300 miles distant while the latter is more than 500 miles distant. These results were obtained on a Round circuit using one tube.

The writer is nearly 200 miles from the nearest radiocasting station and three miles from the nearest receiving set. This may seem ideal to the radio fan who lives next door to a high-powered station but it has many drawbacks. It requires a very good set to bring in the stations night after night with sufficient volume for complete satisfaction.

With a three-stage audio frequency amplifier added to the Round circuit, WFAA of Dallas, Texas was brought in with sufficient volume on their regular wave to operate a loud speaker. The amplifier used one stage of choke coupled and two stages of transformer coupled. The first loop was used.

Some very interesting things were no-

good tubes
 & for a
 good set

MMAGNATRONs have reached that degree of excellence where the mere name is synonymous with the very best in vacuum tubes. You have but to use MAGNATRONs to form the same opinion.

MAGNATRONs have received the unqualified approval of radio fans and radio engineers alike. And small wonder --- when you realize that the design and manufacture of MAGNATRONs is carried on by an organization of men who have devoted a decade and more to vacuum tube problems.

MAGNATRONs are made in three types; the DC-201A, the DC-199 with large base, and the DC-199 with miniature base. Your dealer will gladly recommend all of them to you.

All Types—\$3.00

MAGNATRONs

Magnatrons are manufactured and guaranteed by the Conwey Electric Laboratories New York City.

MARVELOUS NEW AUDIO TRANSFORMER
 adds a musical quality to any set far beyond anything you ever heard before.

KARAS HARMONIK
 Amplifies low, middle and high tones—all to the same big volume, thus eliminating distortion. Brings out the vital harmonics and overtones of music. Price \$7.00. Write Karas Electric Co., Dept. 59-39, 4040 N. Rockwell St., Chicago

ticed when using the seven-wire loop. Strongest signals were obtained with the loop leaning toward the south at an angle of about 5 degrees. When the loop was tipped toward the north the signals gradually grew weaker until an angle of 45 degrees was reached when no sound of any kind could be received. The best distance recorded with these loops on the single tube circuit was about 800 miles.

Solicitor of Patents and
 Trade Marks
 Counsellor in Patent Causes

JOHN FLAM

formerly of the Examining Corps, U. S. Patent Office, also of the Patent Department, General Electric Company. Specializing in Electrical and Radio Inventions. Graduate Electrical Engineer and Lawyer.

Member of the Federal Bar
 1009 Merchants National Bank Bldg.
 Los Angeles, Calif.

Tell them that you saw it in RADIO

MELCO SUPREME



"THE MAGIC CARPET"

YOU tour the world in a night with your MELCO Supreme—a five tube tuned radio frequency Receiver with a unique low-loss AmSCO chassis. Tuned by inductance—not capacitance—it is without parallel for purity and precision of reception.

Write for Literature

AMSCO PRODUCTS INC. BROOME & LAFAYETTE STREETS. N.Y.

The Romance of the Sea!

Read the Story of the Life of a Sea-going Radio Operator

\$1.00
Per Copy

"THE RADIOBUSTER"
SENT POSTPAID ANYWHERE
PACIFIC RADIO PUB. CO.
Pacific Bldg. San Francisco, Calif.

\$1.00
Per Copy

NEW WAVELENGTH ALLOCATIONS OF 500 WATT (OR MORE) RADIO-CAST STATIONS

Corrected to February 4, 1925

*Class B Stations.

Call	Address	Watts	Meters	Kilo Cycles
*KDKA	Westinghouse Elec. & Mfg. Co. E. Pittsburgh, Pa.	1000	309.1	970
KDPM	Westinghouse Elec. & Mfg. Co., Cleveland Ohio	500	250	1200
*KFAE	State College of Wash., Pullman, Wash.	500	333.1	900
KFAF	Western Radio Corp. Denver, Colo.	500	278	1080
KFAU	Boise High School, Boise, Idaho	500	275	1090
*KFDM	Magnolia Petroleum Co., Beaumont, Tex.	500	315.6	950
KFGH	Stanford University, Calif.	500	273	1100
KFGX	First Presbyterian Church, Orange, Tex.	500	250	1200
*KFI	Earl C. Anthony Inc., Los Angeles, Calif.	1500	467	642
KFKB	Brinkley, Jones Hosp. Assn., Milford, Kans.	500	273	1100
KFKU	University of Kansas, Lawrence, Kans.	500	275	1090
*KFKX	Westinghouse Elec. & Mfg. Co., Hastings Nebr.	1500	288.3	1040
KFMQ	Univ. of Arkansas, Fayetteville, Ark.	500	275	1090
*KFMX	Carleton College, Northfield, Minn.	750	336.9	890
KFNF	Henry Field Seed Co. Shenandoah, Iowa	500	266	1130
*KFOA	Rhodes Department Store, Seattle, Wash.	500	450.2	1666
KFPT	Radio Service Corp. Salt Lake City, Utah	500	261	1150
KFQX	Alfred H. Hubbard, Green Bldg., Seattle, Wash.	500	233	1290
*KFRU	Etherical Studios, Bristow, Okla.	500	296.9	1010
KFSG	Echo Park Evang. Assn., Los Angeles, Calif.	500	278	1080
*KFUO	Concordia College, St. Louis, Mo.	500	545.1	550
*KGO	General Electric Co., Oakland, Calif.	1500	299.8	1000
KGU	M. A. Mulroney, Honolulu, H. T.	500	360	833
*KGW	Morning Oregonian, Portland, Ore.	500	485.1	610
*KHJ	Times-Mirror Co., Los Angeles, Calif.	500	404.1	742
*KJS	Bible Inst., Los Angeles, Calif.	500	293.9	1020
*KLX	Tribune Pub. Co., Oakland, Calif.	500	509.9	588
*KNX	L. A. Express, Los Angeles, Calif.	500	336.9	890
*KOA	General Electric Co., Denver, Colo.	1500	322.4	930
*KOB	State College, New Mexico	500	348.6	860
KOP	Police Department, Detroit, Mich.	500	278	1090
*KPQ	Hale Bros. Inc., San Francisco, Calif.	500	429.5	698
KQV	Doubleday-Hill Elec. Co., Pittsburgh, Pa.	500	275	1090
*KSAC	Kans. State Agric. College, Manhattan, Kans.	500	340.7	880
*KSD	Post Dispatch, St. Louis, Mo.	500	545.1	550
*KTHS	Arlington Hotel, Hot Springs, Ark.	500	374.8	800

Continued on Page 82



Bracket mounting type, complete \$4.50.

One Pull on the Jones MULTI-PLUG instantly disconnects antenna, ground, A and B batteries from your set. One push reconnects. And it can't be plugged in wrong! Eight foot cable permits placing batteries out of way—in basement, closet or elsewhere. Makes your set portable. All leads plainly coded.

Jones MULTI-PLUG

THE STANDARD SET CONNECTOR

Nothing else like it. Enables anyone to connect your set with safety. Prevents burning out tubes or shorting batteries. 100 per cent foolproof. Standard on Zenith, Workrite and many other leading sets. Ask your dealer to put one on the set you buy, if it isn't already equipped. Carried by all jobbers. Any dealer can supply you. May be ordered direct by stating dealer's name. Folder mailed free.



Patent Applied For

Binding Post Type complete with seven coded leads for attaching to binding posts of any set and 8 foot coded cable—

\$5.00

Lombard J. Smith,
24 N. San Pedro St.,
Los Angeles, Cal.
A. S. Lindstrom,
274 Brannan St.,
San Francisco, Cal.

Mr. H. A. Killam,
146 1/2 N. Tenth St.,
Portland, Oregon
Mr. G. H. Maire,
95 Connecticut St.,
Seattle, Washington

Howard B. Jones, 614 S. Canal St. Chicago

Sickles Diamond-Weave Coils

Patented August 21, 1923

For Craig, Roberts and Hoyt Circuits

Sickles Coils were chosen by Albert G. Craig in designing his remarkable new Reflex Receiver using the new Sodian detector, and are specified by him, for this circuit in the February issue of Popular Radio. This coil set No. 20, is priced at \$4.50.

For the very popular Roberts Circuit the Sickles Coil Set No. 18 (\$8.00) is standard equipment. Unit No. 1 has primary and secondary coils. Unit No. 2 has primary secondary, neutralizing coil and tickler. Broad variation in coupling adjustments is provided for. Tickler is provided with 180 degree dial control.

Coils for the Hoyt Circuit at \$8.50 a set, for the Knockout Reflex Circuit at \$4.00 a pair and the Tuned Radio Frequency coil at \$2.00 are among the standard Sickles coils. We manufacture special coils also for manufacturers' requirements.

Sickles Diamond Weave Coils have been specified for use in the Hoyt System of Signal Augmentation, by the inventor, Francis R. Hoyt. We have a limited number of blue printed copies of Mr. Hoyt's original laboratory notes on this new system of radio reception, together with nine circuit sketches, which will be sent free to you upon receipt of this coupon and four cents for postage.

The F. W. Sickles Co.,
338 Worthington St.,
Springfield, Mass.

Please send information of Hoyt System
Name
Address

The New CHELSEA

SUPER-FIVE

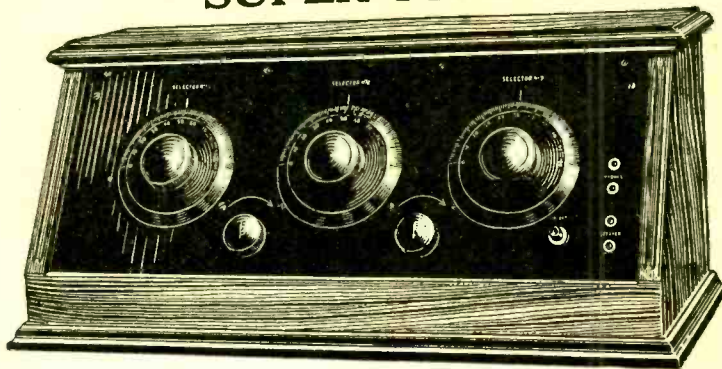

5 TUBE RECEIVER \$50.00

West of Rocky Mountains \$55.00

The ULTIMATE of SELECTIVITY

In thousands of homes the name CHELSEA is synonymous with good radio maintaining always a rigid standard of supreme quality. Now CHELSEA manufacturers have succeeded in embodying in a low price model—CHELSEA SUPER FIVE—the extraordinary receiving principles of the finest non-regenerator set. Distance! Volume! With selectivity, plus a cabinet finished in rich mahogany with shielded Bakelite, making the new CHELSEA the logical set to own.

On sale at all good radio dealers. Send for catalog today.

CHELSEA RADIO COMPANY

179 SPRUCE STREET ~ CHELSEA, MASS.

Chicago St. Louis Seattle Denver Los Angeles San Francisco Cleveland

The Andrews Deresnadyne

RADIO RECEIVING SET

Combines tone quality and selectivity with distance and volume. Price \$150 without accessories

ANDREWS RADIO CO., 327 S. La Salle St., Chicago

Send \$1.00 for a trial subscription to "RADIO" for 6 months.

McCormack~More Clearly

on the

FRESHMAN MASTERPIECE

WHEREVER you are in this country you can easily tune in John McCormack, Bori, Alda and the host of other Metropolitan Opera artists, now broadcasting every other Thursday evening, from WEA F and other stations.

The Freshman Masterpiece assures true to life reproduction with real loud speaker volume. Brings out every single note distinctly, with matchless tonal qualities.

The easiest of all sets to operate.



A five tube tuned radio frequency receiver, made of the finest low loss materials and in a beautiful genuine solid mahogany cabinet, that is attractive enough for the most pretentious room, and at sixty dollars, economical enough for the most modest. Combining all points essential to the perfect receiver, it is the greatest value ever offered in a radio receiving set.

Chas. Freshman Co. Inc.
Radio Receivers and Parts
FRESHMAN BUILDING
240-248 WEST 40TH ST - NEW YORK, N.Y.

These artists broadcasting through courtesy of Victor Talking Machine Co.

Every genuine Freshman Masterpiece has the serial number and trade mark riveted on the sub-panel. Sets are not guaranteed if number has been removed or tampered with. Beware of imitations. Insist upon the genuine

Send for Trial Subscription—\$1.00 for Six Months



FROST-RADIO

FROST-RADIO PAN-TAB JACKS ARE BEST for YOUR RADIO SET

The finest radio jacks made, for either panelhung assembly or usual installation.

At your dealer's, 70c to \$1.00 list.

HERBERT H. FROST, Inc.
314-324 West Superior Street Chicago

MONEY SAVING CATALOG SENT FREE
RADIO
TIMES SQUARE AUTO SUPPLY CO. INC.
BROADWAY AT 56th ST New York

Your Crystal Set

will work 400 to 1000 miles if made by my plans. No tubes or batteries. Copyrighted plans \$1.00; or furnished FREE with complete parts for building set, including special coil and panel correctly drilled for only \$5.00. Satisfaction guaranteed or money refunded. Satisfied customers everywhere. Particulars freq.

LEON LAMBERT

542 Kaufman Bldg. Wichita, Kansas

Continued From Page 80

KTW	First Presbyt. Church, Seattle, Wash.	750	360	833
*KYW	Westinghouse Elec. & Mfg. Co., Chicago, Ill.	1500	535.4	560
KZRQ	Far Eastern Radio, Inc., Manila, P. I.	500	222	1350
WAAW	Grain Exchange, Omaha, Neb.	500	278	1080
WABN	Ott Radio, Inc., La Crosse, Wis.	500	244	1230
*WAHG	A. H. Grebe Co., Richmond Hill, N. Y.	500	315.6	950
*WBAP	Star-Telegram, Fort Worth, Tex.	1000	475.9	630
*WBAV	Erner & Hopkins Co., Columbus, Ohio	500	293.9	1020
WBBG	Irving Vermilya, Mattapoisett, Mass.	500	248	1210
WBBR	Peoples Pulpit Assn., Roseville, N. Y.	500	273	1100
WBCN	Foster & McDonnell, Chicago, Ill.	500	266	1130
*WBZ	Westinghouse Elec. & Mfg. Co., Springfield, Mass.	1500	331.1	900
*WCAF	Kaufman & Baer Co., Pittsburgh, Pa.	500	461.3	650
WCAJ	Nebraska Wesleyan Univ., University Place, Nebraska	500	275	1090
*WCAL	St. Olaf College, Northfield, Minn.	500	336.9	890
*WCAP	C. & P. Tel. Co., Washington, D. C.	500	468.5	540
WCAT	S. D. Sch. of Mines, Rapid City, S. Dak.	500	240	1250
WCAU	Durham & Co., Philadelphia, Pa.	500	278	1080
*WCB D	W. G. Voliva, Zion, Ill.	500	344.6	870
*WCCO	Washburn-Crosby Co., Minneapolis, Minn.	500	416.4	720
*WCX	Detroit Free Press, Detroit, Mich.	500	516.9	580
*WDAF	K. C. Star, Kansas City, Mo.	500	365.6	820
WDRY	No. Shore Cong. Church, Chicago, Ill.	500	258	1160
*WDWF	D. W. Flint, Cranston, R. I.	500	440.9	680
*WEAF	Am. Tel. & Tel Co., New York City	2000	491.5	610
WEAI	Cornell Univ., Ithaca, N. Y.	500	254	1180
*WEAO	Ohio State Univ., Columbus, Ohio.	500	293.9	1020
*WEAR	Goodyear Tire & Rubber Co., Cleveland, O.	1000	389.4	770
WEAY	Iris Theatre, Houston, Tex.	500	360	833
*WEBH	Edge water Beach Hotel, Chicago, Ill.	1000	370.2	810
WEBJ	Third Ave Ry Co., New York City	500	273	1100
WEBW	Beloit College, Beloit, Wis.	500	268	1120
*WEEL	Edison Elec. Illum. Co., Boston, Mass.	500	475.9	630
*WEMC	Emmanuel Miss. College, Berrien Springs, Mich.	500	285.5	1050
*WFAA	News and Journal, Dallas, Tex.	500	475.9	630
WFBH	Concourse Radio Corp., N. Y. C.	500	273	1100
*WFI	Strawbridge & Clothier, Philadelphia	500	394.5	760
*WGBS	Gimbel Bros., New York City	1000	315.6	950
*WGN	The Tribune, Chicago, Ill.	1000	370.2	810
*WGR	Fed. Tel. Mfg. Corp., Buffalo, N. Y.	750	319	940
WGST	School of Technology, Atlanta, Ga.	500	270	1110

* Class B Station.

Continued on Page 86



18 STYLES ENGRAVED
A Marking for Every Need in

"Read'em" Binding Posts

"The Knobs Can't Come Off"

The New and Improved Post that Improves the Appearance of Every Set.



The Utmost in Quality at the Lowest Price at Your Dealer's or Sent Post-paid.
15c Each

MARSHALL-GERKEN CO.
Toledo, Ohio



New LeFAX RADIO HANDBOOK—\$2.00
(Seventh Edition)
in bound form. For sale by
"RADIO," San Francisco

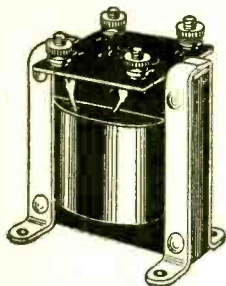

DONGAN

AUDIO TRANSFORMERS
Choice of

28 Set Manufacturers

Ratio 3 1/2 to 1 and 6 to 1.

Fits all hook-ups.

For consistently smooth performance use Dongan Audio Transformers. At all good dealers or supplied direct from factory. Special proposition to manufacturers, mounted or unmounted type. Greatly increased manufacturing facilities insure prompt deliveries to manufacturers and jobbers.

Dongan Electric Manufacturing Co.

2981 Franklin St. Detroit, Michigan

Distributors for Western Coast:

Sierra Electric Company,
515 Market St., San Francisco.
443 S. San Pedro St., Los Angeles.
222 Hinckley Bldg., Seattle.

Robinson Sales Co.,
53 Fourth St., Portland, Oregon.

Transformers of Merit for 15 Years

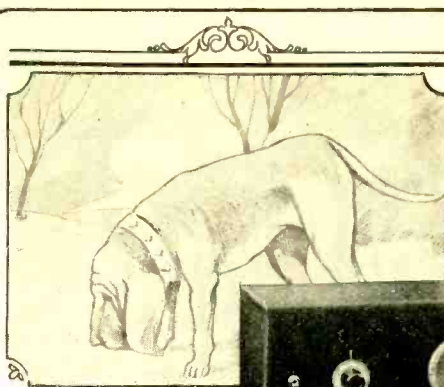

Sensitivity



The bloodhound, remarkable for the acuteness of its smell, can pick up a scent and follow a trail when all else fails.

-never before thought possible!



THE ULTRADYNE KIT

Consists of 1 Low Loss Tuning Coil, 1 Special Low Loss Coupler, 1 Type "A" Ultraformer, 3 Type "B" Ultraformers, 4 Matched Fixed Condensers.

To protect the public, Mr. Lacault's personal monogram seal (R. E. L.) is placed on all genuine Ultraformers. All Ultraformers are guaranteed so long as this seal remains unbroken.

\$30.00



How to Build and Operate the ULTRADYNE

32 page illustrated book giving the latest authentic information on drilling, wiring, assembling and tuning the Model L-2 Ultradyne Receiver. **50c**

With the extreme acuteness of the bloodhound's scent, the Model L-2 Ultradyne detects the faintest broadcast signals—signals that are "dead" to other receivers—regenerates and makes them audible on the loud speaker.

It's here, where the development of other super-radio receivers has halted; the Ultradyne forges ahead.

The unusual sensitivity of the Model L-2 Ultradyne is due to the successful application of regeneration, to the famous Modulation System of radio reception, recently perfected by R. E. Lacault, E. E., A. M. I. R. E., Chief Engineer of this Company and formerly Radio Research Engineer with the French Signal Corps Research Laboratories.

It's this development, an exclusive feature of the Model L-2 Ultradyne, that makes it possible to receive greater distance on the loud speaker. In addition the Ultradyne is the most selective receiver known. Regardless of close similarity in wavelength, it selects any station within range—brings in broadcasting clearly, distinctly, faithfully.

Everything that the Model L-2 Ultradyne means in actual results and genuine satisfaction you will appreciate the first evening you operate it.

Write for free descriptive folder.

ULTRADYNE

MODEL L-2

CARL A. STONE COMPANY

644 New Call Bldg., San Francisco, Calif.

1116 Minor Ave., Seattle, Wash.

429 Insurance Exchange Bldg., Los Angeles, Calif.

PHENIX RADIO CORPORATION

9 Beekman Street

New York

THE Antennaphone

REPLACES THE AERIAL INCREASES SELECTIVITY IMPROVES RECEPTION

NO LOOP NO AERIAL

Complete with wire Easy to install

The Antennaphone is not attached to but merely placed under the telephone. Sold with a money-back guarantee. At Your Dealer or sent by mail upon receipt of one dollar. ANTENNAPHONE CO., 90 West St., New York City, N. Y.

"THE RADIOBUSTER"

Written by the author of "On the Trail of the Tube Sharks"

This wonderful book sells for only \$1.00

PACIFIC RADIO PUB CO.

San Francisco

The most distant stations are heard

With Myers Tubes you can get virtually every station on this continent and elsewhere. England, France, Cuba, Hawaii, Porto Rico, Japan are being heard daily with one, two or three Myers Tubes.

They are noise free—locate stations easily—clear reception—and are interchangeable. Each Myers Tube passes 49 separate and individual tests. Each is actually tested for reception.

Three types for dry and storage batteries. All ready to mount. At your dealer's or sent postpaid for..... **\$4**

252 Craig Street, Montreal

10

Myers Tubes

Practically Unbreakable



"The World On Your Dial"

Write for descriptive circular

JANUARY "RADIO"

25c Per Copy Only a Few Left

"RADIO" SAN FRANCISCO

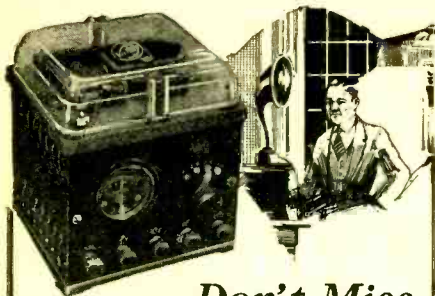

Don't Miss a Program

Get a

Valley Battery Charger

Sometime, haven't you wanted to hear a certain radio program . . . but could not because your storage battery was down?

Don't let it happen again. Add a Valley Battery Charger to your radio set, and you can always be ready to listen in. With the Valley Charger you can completely recharge any radio battery at home overnight.

Quiet in operation.
Full 6-ampere charging rate.
No liquids. No bulbs.

The Valley Battery Charger recharges 2-volt peanut tube cells, 6-volt A batteries, and from one to four 24-volt B batteries. Takes about a dime's worth of current for a full charge.

Plugs into the ordinary light socket like a fan or other household necessity, and is just as easy to operate. It has a grained and engraved Bakelite panel which harmonizes with any radio set. Clear glass top shows the simple, patented working parts at all times.

At radio dealers everywhere.

VALLEY ELECTRIC COMPANY

Rialto Bldg., San Francisco

Construction Hints

50-Watt Socket Adapter

By O. M. SHAW, 5BO

For emergency use in case a 50-watt tube blows, it is well to have ready a socket adapter to enable the use of 5-watt tubes without any change in the set except to reduce the filament potential by 2 volts. Such an adapter can be

8-32 hexagon nuts which hold them in place. Solder connections to the sockets on top of these rods and nuts. The wooden block should be dry and well-seasoned and boiled in paraffine.

One, two or four sockets may be mounted in this way either for quick change from high to low power or in case of a blow-out.

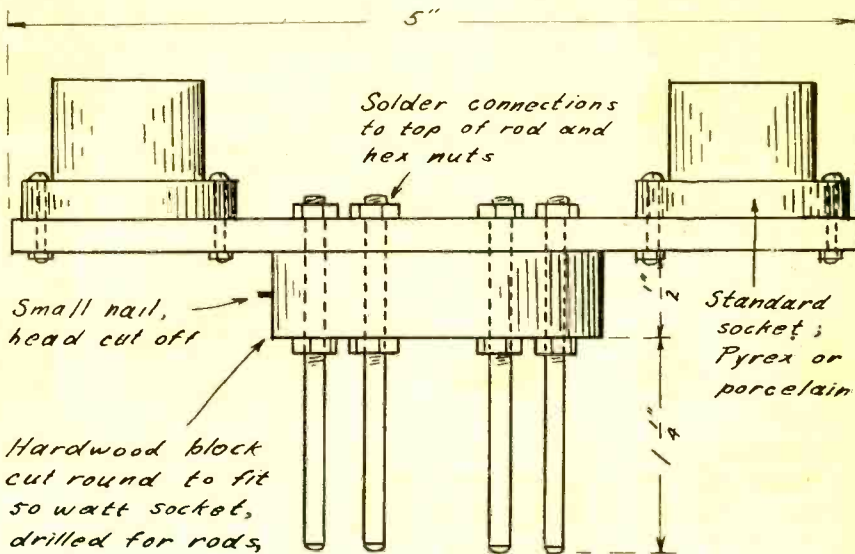

50-Watt Socket Adapter

easily made as shown in the accompanying sketch.

The adapter consists of two pyrex or porcelain sockets mounted on either end of a bakelite strip 2x5x3-16 in. Through this strip four holes are drilled to correspond to four holes drilled in a half-inch block of hardwood cut so as to exactly fit inside the 50-watt socket. Through these holes place 2-in. rods cut from brass rod with 8-32 threads to fit

Ever happen to think that the fellow on the ship who is causing you some interference may be working thru far worse interference conditions than you are, and with the difference that if it gets too bad for you, that you can hang your phones up and go to bed, while the man on the ship has to get his traffic through, or else plan to look for a new job—if he can get on—when he gets ashore.

One Control For Neutrodyne

By LEWIS F. HALLORAN

Any three-control neutrodyne receiver can be easily changed into a single-control instrument for local reception by cutting out the radio fre-

quency circuit as shown in the accompanying circuit diagram. The selectivity is such that KGO, KPO and KLX can be separated within five miles of the nearest station. There is also a saving in filament current consumption.

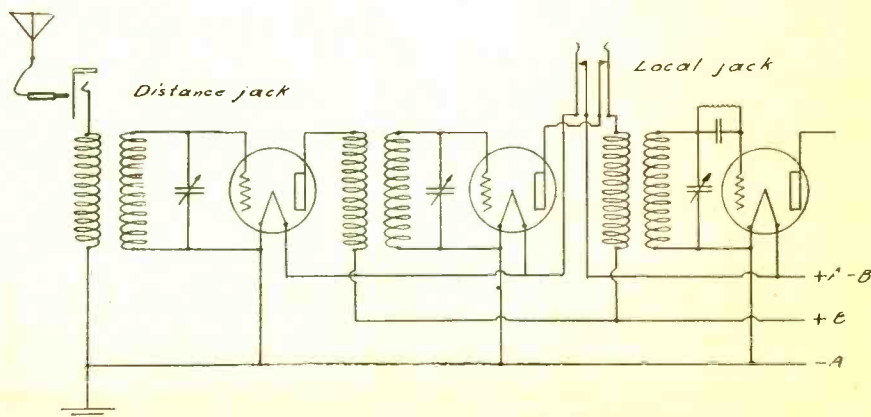

Modification of Neutrodyne to Give One Control

Why It Is Better

“**M**ASTER of Every Note in the Orchestral Range” is the **PROVEN** claim of the Federal No. 65 Audio Frequency Transformer! Volume without distortion is the basis for the beauty of Federal Tone.

From its oversize locking nuts to its heavy brass mounting feet, the Federal No. 65 Transformer incorporates the same engineering skill that has made Federal the recognized leader in electrical communication apparatus since 1890.

Insist upon Federal parts for your “pet” hook-up. There are over 130 standard parts bearing the Federal iron-clad performance guarantee.

FEDERAL TELEPHONE &
TELEGRAPH CO.
Buffalo, N. Y.

Hoston New York Philadelphia
Chicago Pittsburgh San Francisco
Bridgeburg, Canada



Federal

Standard **RADIO** Products

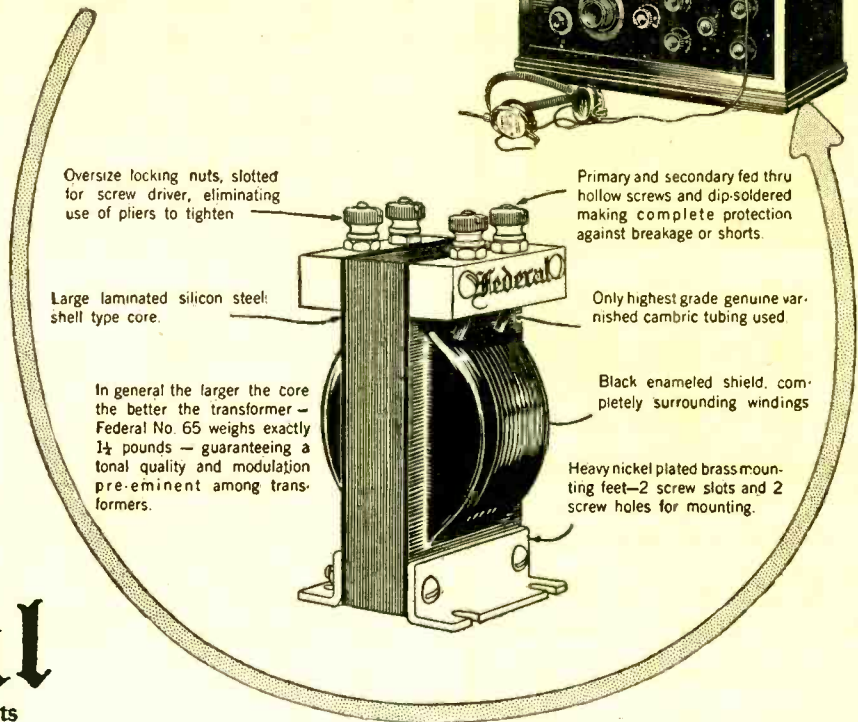
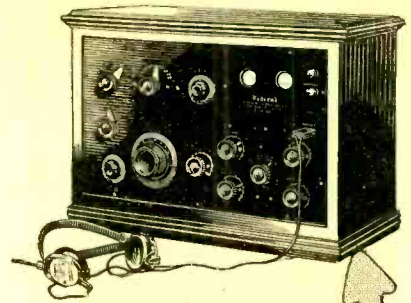

TRADE MARK REGISTERED

YANKEE TUBES

Proven Beyond All Doubt—

“The Ace of Independents”

TYPES \$ **3.00**
199-201A

Sold only thru well-established retail dealers

Distributed by
W. E. & W. H. JACKSON
San Francisco
MARSHALL-WELLS
Portland
THE BANTA CO.
Los Angeles
RADIO SUPPLY CO.
Los Angeles

DEALERS—Write to the distributor in your territory as shown below for attractive proposition

BALDWIN PACIFIC & CO., San Francisco
(Pacific Coast Representatives)

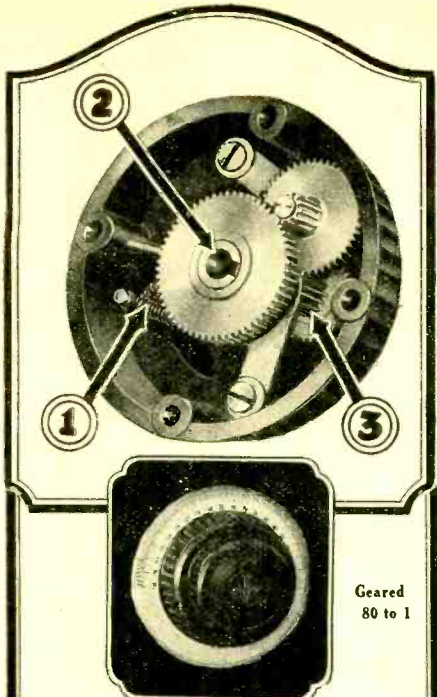

Geared
80 to 1

DOMINATING ACCURATUNE FEATURES

1—*No Back Lash.* A new principle takes up all lost motion and back lash and produces a very smooth operating instrument.

2—*Long center bushing eliminates all dial wobble* and takes all standard condenser shafts. Permits dial mounting flush with panel. No cutting of condenser shafts.

3—*Gear Mesh* and alignment perfected to the same degree of accuracy as the mechanism of a watch. Ratio 80-1.

You can change from ordinary dials to Accuratune Micrometer Controls in an instant, no set alterations necessary. More efficient than built-in verniers—a revelation in fine tuning.

At your dealers. Otherwise send purchase price (\$3.50) and you will be supplied postpaid.

Write for descriptive folder.

MYDAR RADIO COMPANY
9-G Campbell St., Newark, N. J.

Canadian Representatives
RADIO, LTD., MONTREAL

ACCURATUNE

REGISTERED TRADE MARK U.S. PAT. OFF.
MICROMETER CONTROLS

Use RESISTANCE!

DURHAM

Grid Leaks



75¢

Variable:—
No. 101—1.10 to 5 megs.—soft tubes.
No. 201A—2 to 10 megs.—hard tubes.
No. 100—1000 to 100,000 ohms by-pass.

Metalized Fixed:—
Over ¼ meg. 50¢; under, 75¢.

at dealers
or postpaid

DURHAM & CO., INC., 1936 Market Street, Philadelphia

Many Bargains Are Listed
on Page 95.

NEW WAVELENGTH ALLOCATIONS

Continued From Page 82

*WGY	General Elec. Co., Schenectady, N. Y.	1500	379.5	790
*WHA	Univ. of Wisconsin, Madison, Wis.	500	535.4	560
*WHAA	University of Iowa, Iowa City, Iowa	500	483.6	620
WHAD	Marquette Univ., Milwaukee, Wis.	500	275	1090
*WHAS	Courier Journal, Louisville, Ky.	500	399.8	750
*WHAZ	Rensselaer Poly. Inst., Troy, N. Y.	500	379.5	790
*WHB	Sweeney School, Kansas City, Mo.	500	365.6	520
*WHN	George Schubel, New York City	500	361.2	530
*WHO	Bankers Life Co., Des Moines, Iowa	500	526	570
*WIP	Gimbel Bros., Philadelphia, Pa.	500	508.2	590
*WJAD	Jackson's Radio Lab., Waco, Tex.	500	352.7	550
*WJAR	The Outlet Co., Providence, R. I.	500	305.9	980
WJAS	Pitts. Radio Supply House, Pittsburgh, Pa.	500	275	1090
*WJJD	Loyal Order of Moose, Mooseheart, Ill.	500	302.8	990
*WJY	Radio Corporation of America, N. Y. C.	1000	405.2	740
*WJZ	Radio Corporation of America, N. Y. C.	1000	454.3	660
*WKAQ	Radio Corp. of Porto Rico, San Juan, P. R.	500	340.7	880
*WKAR	Mich. Agric. College, East Lansing, Mich.	500	285.5	1050
WLBL	Wisc. Dept. of Markets, Stevens Pt. Wisc.	500	278	1080
*WLIT	Lit Bros., Philadelphia, Pa.	500	394.5	760
*WLS	Sears, Roebuck & Co., Chicago, Ill.	500	344.6	870
*WLW	Crossley Radio Corp., Cincinnati, Ohio	1500	422.3	710
WMAF	Round Hills Radio Corp., Dartmouth Mass.	500	360	833
WMAK	Norton Laboratories, Lockport, N. Y.	500	266	1130
*WMAQ	Daily News, Chicago, Ill.	500	447.5	670
*WMBF	Fleetwood Hotel, Miami Beach, Fla.	500	384.4	780
*WMC	Commercial Appeal, Memphis, Tenn.	500	499.7	600
*WMIH	Ainsworth Gates Radio Co., Cincinnati, Ohio	750	422.3	710
*WNAC	Shepard Stores, Boston, Mass.	500	280.2	1070
*WNYC	City of New York, N. Y.	1000	526	570
*WOAI	Southern Equip. Co., San Antonio, Tex.	500	394.5	760
*WOAN	James D. Vaughn, Lawrenceburg, Tenn.	500	282.8	1060
*WOAW	Woodmen of the World, Omaha, Neb.	500	526	570
WOAX	F. J. Wolff, Trenton, N. J.	500	240	1250
*WOC	Palmer School of Chiropractic, Davenport, Iowa	1500	483.6	620
WOI	Iowa State College, Ames, Iowa	500	270	1110
*WOO	John Wanamaker, Philadelphia, Pa.	500	508.2	590
WOQ	Unity School of Christianity, Kansas City, Mo.	500	278	1080
*WOR	L. Banherger & Co., Newark, N. J.	500	405.2	740
WORD	Peoples Pulpit Assn., Batavia, Ill.	500	278	1080
*WOS	Mo. State Marketing Bureau, Jefferson City, Mo.	500	440.9	680
*WPG	Municipality Atlantic City, N. J.	500	299.8	1000

* Class B Station. Continued on Page 92

What a Combination!

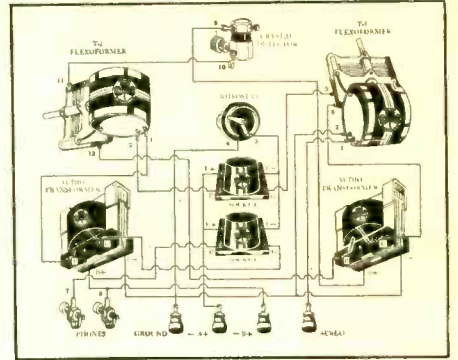

5 Tube Volume and Distance—Reflex Clarity

Here's a powerful little set! Two tubes do the work of five. Cuts Battery cost 60%. Gives consistent loud speaker reception *within a radius of 1000 miles*—and we don't mean maybe! The

Shamrock-Harkness Two-Tube Reflex

is the result of months of investigation by Shamrock engineers to build the best features of the most powerful present-day circuits into one receiver—at the lowest possible cost!

Every part included in the licensed Shamrock-Harkness Kit has been especially designed for this circuit, carefully balanced to give maximum results. Avoid all imitations. The genuine Shamrock-Harkness parts are backed by our unconditional guarantee!

Price Complete \$35

Also ask to see the improved Shamrock-Harkness Three-Tube Counterflex,

The Wonder Set \$39.50

The set for the masses as well as the classes



Licensed under U. S. Patent Office, Serial No. 719,264 for Radio Receiver Systems.

SHAMROCK

(FOR SELECTIVE TUNING)

SHAMROCK MFG. CO.,

30-A Market St., Newark, N. J.

I enclose 10 cents (U. S. stamps or coin) for copy of "Shamrock Radio Builder's Guide Book" containing diagrams and complete instructions for building 10 sets at prices ranging from \$15 to \$50.

Name _____

Address _____

RADIO FOR EVERYBODY

By A. C. LESCARDOURA

Completely Re-written and Re-illustrated.
The Book That Has Grown With Radio.

Completely re-written and re-illustrated Tells in plain language how to buy or build your own set. How to install; how to tune in; how to get the best results. Explains all the circuits, vacuum tubes, radio and audio amplification, loud speakers, regeneration, static, and everything else about the subject.

THE ONE BOOK EVERY ENTHUSIAST NEEDS

As Radio develops the story of the new wonders being brought to light will be told month by month in

THE SCIENTIFIC AMERICAN

by the scientists who develop them. Every man and woman who would keep thoroughly posted on the march of progress should read the Scientific American.

HOLIDAY OFFER:

The New RADIO FOR EVERYBODY together with a year's subscription to the SCIENTIFIC AMERICAN for \$5. The New RADIO FOR EVERYBODY together with two subscriptions to SCIENTIFIC AMERICAN, or with one subscription for two years for \$8. Two copies of the New RADIO FOR EVERYBODY together with two subscriptions to the Scientific American, or with one subscription for two years for \$9.

Send in the coupon below. This offer is only temporary.

Scientific American Publishing Co.,
Woolworth Building, New York City.

Send me the new RADIO FOR EVERYBODY and the SCIENTIFIC AMERICAN as indicated by my check mark in the box at the bottom of this coupon for which I enclose check.

Name _____

Address _____

Additional Name _____

Address _____

Radio For Everybody, Scientific

American for one year

\$5

Two subscriptions to the

Scientific American

\$8

Two copies of Radio for Everybody. Two

subscriptions to the Scientific American

\$9



THE PROUDFOOT

Low Loss Condenser

—specified in many popular hook-ups

Radio experts have found the Proudfoot One Knob Condenser ideal for their special circuits. Its smooth, efficient action, even under the most trying circumstances, has established confidence in its performance—confidence to the extent that the Proudfoot is specified by name in many popular hook-ups.

See the Proudfoot today. You'll want one for your set. It's made in the popular sizes and priced right.

Number of Plates	M. F. C.	With Vernier Dial and Knob	Without Vernier Dial and Knob
13	.00025	\$3.75	\$3.25
17	.0003	4.40	3.90
25	.0005	4.50	4.00
43	.001	5.75	5.25

4 in. polished bakelite two piece (for group and vernier readings) dial. \$1.00
Polished bakelite knob with pointer (for rheostat) to match. .50

If your dealer cannot supply you, write us, sending us his name. We will see that you are supplied and we will send you literature direct.

CRUVER MFG. CO., 2456 W. Jackson Blvd., Chicago, Ill.

A. C. H. Three-Tube Concert Receiver

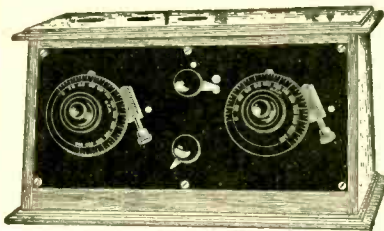

SELECTIVITY

Using sensitive instruments in connection with two A. C. H. Worm Drive Sharp Tuning Instruments. Can be used as one or three tube Receiver. Operates on 199 or 299 dry cell tubes. Batteries Amplifier 90 volt B. Detector 22½ volt B. A battery, three dry cells. C battery, one dry cell. All connections on back. Installment Plan. No References.

WRITE US AS FOLLOWS:

A. C. Hayden Radio & Research Co.,
Brockton, Mass.

Gentlemen:

Enclosed please find \$20.00. Send me one A. C. H. Three Tube Receiver. Upon receipt of same I agree to pay you \$1.00 a month for fifteen months until the total amount of \$35.00 is paid... This Receiver is to remain your property until full amount is paid. You guarantee this set to operate on the air.

SIGNED.

Wonderful Value—Limited Production—Mail Orders Only

A. C. Hayden Radio and
Research Co.

BROCKTON, MASS., U. S. A.

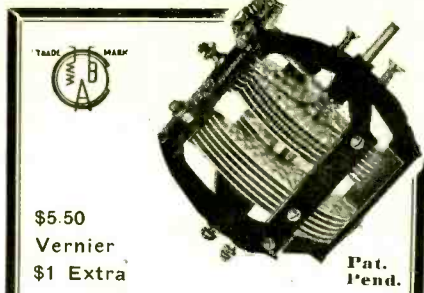

\$5.50
Vernier
\$1 Extra

Pat.
Pend.

"Bruno" 3 in 1

22 Plate

Ultra-Vario Condenser

A balanced precision instrument scientifically designed with 3 capacities

.0005 .00025 .00125

Bruno Radio Corporation
NEW YORK

Pacific Coast Representative

A. S. LINDSTROM

274 Brannan St. San Francisco, Calif.

Balkite Battery Charger. Charges 6 volt "A" storage batteries.

Price \$20
East of Rockies \$19.50
In Canada \$27.50

Balkite "B"—replaces "B" batteries and dry cells. Operates from light socket.

Price \$55
In Canada \$75

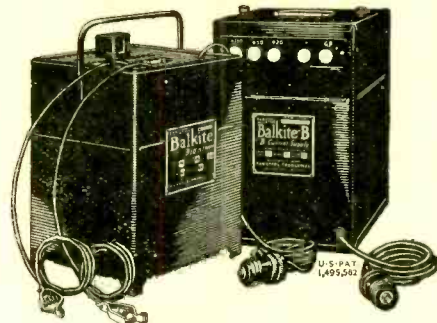

An unfailing power supply for both circuits

Here at last is an unfailing power supply for your radio set. Balkite Radio Power Units furnish constant uniform voltage to both "A" and "B" circuits and give your set greater clarity, power and distance. The Balkite Battery Charger keeps your "A" storage battery charged. Balkite "B" replaces "B" batteries entirely and furnishes plate current from the light socket. Both are based on the same principle, are entirely noiseless and are guaranteed to give satisfaction. Sold by leading radio dealers everywhere.

FANSTEEL PRODUCTS CO., Inc.
North Chicago, Ill.

PACIFIC COAST DISTRIBUTORS:
Seattle, George H. Maire, 95 Connecticut St. San Francisco, A. S. Lindstrom, 274 Brannan St. Los Angeles, Lombard J. Smith, 324 N. San Pedro St. Portland, H. A. Killam, 146½ N. 10th St.

FANSTEEL Balkite Radio Power Units

BALKITE BATTERY CHARGER
BALKITE "B" PLATE CURRENT SUPPLY

New LeFAX RADIO HANDBOOK—\$2.00
(Seventh Edition)
in bound form. For sale by
"RADIO," San Francisco

RADIO CATALOG AND HOOK-UPS FREE

Our great new catalog, fresh from the press, contains the very newest in complete sets, parts and accessories—hundreds of amazing bargains. 250,000 customers testify to our wonderful values and reliability. Complete instructions with diagrams for making most practical popular sets FREE. SEND QUICK for your copy. (Please include name of friend who is interested in Radio.)

THE BARAWIK CO.

Dept. 115

32-40 So. Clinton Street

Chicago

Do You Know

- how to construct a radio receiving set scientifically and the exact function of each part?
- how the wave length of radio signals may be measured by the maximum amplitude method?
- the Heterodyne principle of radio reception?
- how to calibrate a receiving set?

The men who have a thorough understanding of these things are holding good positions in the radio industry today as designers, repairmen, salesmen, engineers and executives. And the field of radio is broadening so rapidly that the supply of trained men never catches up with the demand.

Opportunity In Radio For You

Prepare now for a big future in radio. Even though you may be employed at present—study radio at home in spare time. The Radio Institute of America, the world's oldest radio school, now offers a new, revised Home Study Course that covers every phase of modern radio.

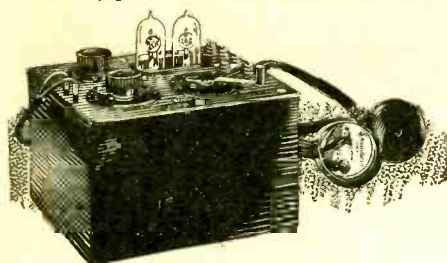

Radiola III Free With Course

A Radiola III complete with two tubes and headset is only one of the four pieces of highest grade apparatus furnished free with the course. 7,000 Radio Institute graduates have secured radio positions. With Radio Institute training, you, too, can enter the ranks of this highly paid profession. Mail the coupon today for more information.

Radio Institute of America
(formerly Marconi Institute)
Established in 1909

322 Broadway New York City

CUT HERE

Radio Institute of America
322 Broadway, New York City

Please send me full information about your Home Study Course of radio instruction.

I am interested in the complete course including code instruction.

I am interested in the technical course without code instruction.

Name

Address

LOOK FOR THIS MARK

BETTER BECAUSE ITS ACTUAL SIZE

Solderdip

THESE LUGS MAKE WIRING A PLEASURE
Your dealer has them in convenient 50c packages of 100 lugs. Jobbers and manufacturers write for samples and prices. Distributed Solely By THE KELLER COMPANY, 821 Market St., San Francisco, U.S.A.

HEINTZ AND
KOHLMOOS

SCIENTIFIC INC. APPARATUS

VOLT-X

VARIABLE GRID LEAK

New! A BALL-BEARING Grid Leak That Stays Put. Screw adjustment expansion contact and resistance unit that cannot wear or tear. Volt-X Grid Leaks are positive and smooth in action with an accurate range of from 1/2 to 15 megohms. Balancing resistances for Superheterodyne and other circuits 30,000-150,000 ohms. They fit any standard leak mounting, and get the absolute maximum from your tubes. They do not wear out. Grid Leak \$1; Grid Leak Mounting 20c.

BURTON & ROGERS

MFG. CO.
755 BOYLSTON ST., BOSTON, MASS.

DeJUR

ONE HOLE MOUNT RHEOSTATS

- 1—Easiest to mount.
- 2—No back panel fussing.
- 3—Perfect contact always.
- 4—Genuine bakelite throughout.
- 5—Contact slider and shaft made in one piece.

At All Dealers
DeJUR PRODUCTS CO.
Broome and Lafayette Sts.,
New York

PATENTS APPLIED FOR

CALLS HEARD

Continued from Page 50

By 6BJX 2823 E. 6th St., Los Angeles, Calif.
1ajo, 1bsd, 1ci, 1cmp, 1lw, 1zt, 2atf, 2brb, 3ab, 3auy, 3bdo, (3bva), 3hj, 3ot, 3qt, 4bq, 4io, 4oa, (4xe), (5aa), (5aaq), 5aex, 5afu, 5agl, 5agq, (5ahd), (5ail), 5aij, 5aiy, 5ajb, 5akn, 5alj, 5amw, 5apq, 5aph, (5aqw), 5asz, 5atf, 5atx, 5azr, 5ca, 5ce, 5cn, 5ic, 5jf, 5lh, 5ll, 5mz, 5nw, 5ot, 5ov, 5ph, (5qy), 5sd, 5uj, 5uk, 5ux, 5wa, 5xau, 5za, 5zav, 7abb, 7adm, 7adp, 7afo, 7ajy, (7akh), 7alk, 7au, (7fq), 7fr, 7gb, (7gm), 7ho, 7ij, 7gq, 7kf, 7ku, 7lq, (7ma), 7mf, 7oj, 7qd, 7sy, 7ws, 7zm, 7zz, 8ada, 8ah, 8apr, 8aud, 8bau, 8bnh, (8bos), 8bpa, 8ced, (8cp), 8cyl, 8cys, (8dal), 8hi, 8lr, 8nb, (8ry), 8atr, 8wa, 8xg, 9abf, 9aby, (9acq), 9ado, 9aey, 9amx, 9axs, 9bcj, (9bdf), 9bdw, 9bf, 9bht, 9bhy, 9bje, 9bm, 9bmx, 9bnf, 9bof, 9bpy, 9brx, 9bwx, 9ca, 9caj, 9ces, (9cea), (9cf), 9cip, 9cis, 9ck, 9cks, 9clq, (9cex), 9cyk, 9cyx, 9dac, 9dad, 9dbz, (9ddp), (9dd), 9dhs, (9dng), 9dit, 9dmj, 9dp, (9dqu), 9dwx, (9eae), 9eak, 9eam, (9efh), 9efm, 9efy, 9efz, 9egh, 9eht, 9ehy, 9ek, 9ely, 9es, (9mm), 9na, (9qi), 9qw, 9xi, 9zb, 9zt, nkf.

Porto Rico: 4sa.
Canada: 2be, 4gt, 5ba, 5ct, 5go, 5hs.
New Zealand: (2ac), 2ap, (4aa), (4ag), 4ak.
Australia: 2yi, 3bd, 3bq.

By 7VN, Kalamia, Wash.
1abf, 1ajx, 1ary, 1awp, 1aww, 1bdx, 1bkq, 1bv, 1ci, 1cme, 1cmp, 1er, 1ez, 1li, 1kc, 1ow, 1pl, 1py, 1xz, 1yb, 2afp, 2ann, 2bg, 2bgi, 2bgo, 2br, 2brb, 2brf, 2by, 2cbg, 2cee, 2cnk, 2cpa, 2cpk, 2cqz, 2cuv, 2dn, 2ku, 2rk, 2xq, 3ab, 3adb, 3adv, 3aha, 3bb, 3bdo, 3bfq, 3bhv, 3bjp, 3bpb, 3bva, 3bwg, 3chc, 3cin, 3hg, 3hh, 3hs, 3mf, 3lg, 3yo, 4bo, 4fz, 4io, 4jr, 4kl, 4ku, 4my, 4xe, 5aa, 5aex, 5afu, 5aiy, 5akn, 5aly, 5am, 5amw, 5ap, 5asb, 5atf, 5ce, 5hl, 5in, 5j, 5lh, 5ls, 5nw, 5ot, 5ox, 5qy, 5sc, 5se, 5uk, 5uo, 5uv, 5za, 6atm, 6bul, 6cmq, 6uo, 7dd, 7zz, 8aa, 8ada, 8ago, 8anb, 8any, 8apr, 8aro, 8atr, 8avd, 8bau, 8bdk, 8bgs, 8bjv, 8blc, 8bnh, 8bpl, 8buk, 8byn, 8ced, 8cip, 8cyp, 8cse, 8csj, 8dal, 8ded, 8dgp, 8dnv, 8hf, 8ef, 8j, 8lw, 8nb, 8rv, 8ry, 8uf, 8up, 8vq, 8ze, 9aad, 9abf, 9aby, 9aci, 9amx, 9aod, 9auy, 9axs, 9azj, 9bav, 9bcj, 9bdw, 9bht, 9bhx, 9bhy, 9bj, 9blk, 9brk, 9bmo, 9bna, 9bnk, 9bob, 9bof, 9bpy, 9brq, 9bsz, 9bvz, 9cap, 9cdv, 9cgx, 9cip, 9cjc, 9cju, 9cju, 9clo, 9cp, 9cpm, 9csg, 9cvo, 9cvs, 9cvg, 9cyx, 9dac, 9daw, 9ddp, 9ded, 9bge, 9dhs, 9dit, 9dng, 9dqm, 9dqu, 9dun, 9dvw, 9dyz, 9eam, 9eas, 9efh, 9ehm, 9eky, 9elb, 9eld, 9hk, 9mf, 9mm, 9nn, 9na, 9nv, 9ny, 9vz, 9xax, 9xw (Fone vy QSA), 9zd, 9zt.

Canadian: 2hv, 4cr, 4dq, 4ej, 4io.
Mexican: BX, 1B.
Special: NKF, NFV, KDKA (Music).
All above heard on 60-85 meters with 1BFG tuner. Complete log kept.

By 2AGI, Karl Roszbach, 620 Wyoming Ave., Elizabeth, N. J.
1aac, (1aam), (1aao), (1aap), (1abp), (1aco), 1acr, (1adm), 1ael, 1aer, 1aev, (1afj), 1afy, 1ai, 1ain, 1ajg, 1ajt, 1ajx, 1akz, 1aip, (1alw), 1ams, 1anq, 1apk, 1avl, (1awd), 1awq, (1axa), 1aya, (1ayn), 1bbe, 1bbg, 1bbh, (1bbr), 1bcr, 1bdp, 1bdx, (1bf), 1biq, 1biz, 1bnk, 1boa, 1bon, (1bpb), (1bqq), 1bz, 1caz, 1cdi, 1cme, 1coj, 1da, 1eo, 1ez, 1hb, 1kx, 1nt, (1or), 1pd, 1pi, 1pk, 1qm, 1ra, 1rh, (1so), 1tv, 1uj, (1vc), 1ya, 1yd, (1zw), 6ea, 6xad, 7abb, 7cy, 7st, 8aaf, (8aaj), 8abf, 8abm, (8acm), 8aey, 8afm, 8afn, (8agw), 8aih, 8ais, 8ak, 8akk, 8al, 8ali, 8aly, 8aow, 8apn, 8apo, 8apt, 8apw, 8apy, 8aq, 8ard, 8avx, 8bau, 8bbi, 8bg, (8biz), 8blr, 8bmy, 8bn, 8bnu, (8boa), 8boe, 8bog, (8boy), 8bpv, 8bsz, 8bv, 8bzd, (8caw), 8cdg, 8ces, (8cfs), (8cfl), (8cjp), 8ck, 8cko, 8ckp, 8cm, 8cni, (8cnx), (8cnz), 8cql, 8cqh, 8cql, 8cuk, (8cux), 8cwl, (8czy), 8daa, 8dan, 8dat, 8daw, 8dag, 8dbi, 8dcv, 8dcz, 8ddw, 8ded, 9ca, 9cbb, 9cbl, 9cbv, 9cca, (9ceb), 9cec, 9cf, 9cgr, 9ckd, 9ckm, 9ctr, 9cvf, 9cvs, 9cyg, 9czo, 9dbk, 9dbl, 9djn, 9djp, 9dmi, 9dnf, 9dnn, 9dnp, 9doz, 9dp, 9dpc, 9dpm, 9dq, 9dqe, 9dqz, 9drs, 9din, 9dub, 9duc, 9dur, 9dvo, 9dvw, 9eas, 9ecb, 9ecv, 9eel, 9ej, 9ejm, (9eft), 9ejy, 9elb, 9ell, 9elq, 9elv, 9ep, 9hp, 9mi, 9mm, 9my, 9ox, 9pb, 9qr, 9ry, 9vc, 9wc, 9zt.

Canadian: (2dn), (3ni).

At 6BNM (ex-8CIK), W. E. Battison, 3250 Madison St., Alameda, Calif.
1all, 4ae, 5ak, 5nj, 5yd, (6abe), (6bhm), (6ctl), 6chx, (6cpd), (6erm), (7alk), 7aea, 7ali, (7adr), (7ahs), 7aj, (7cf), 7gw, 7ki, (7lh), 7mf, (7nh), 7ok, 7qc, 7ry, (7un), (7vn), 8aay, 8bdw, 9cwu, 8dt, 8do, 8er, 8uq, 9atl, 9bji, 9bjk, 9cgn, 9cid, 9dhl, 9eky, 9rh, 9sv.

Canadian: (C-5ba), (C-5hc), C-5cr.

At 6CSO, 1258 W. Pierce St., Phoenix, Ariz.

1aa, 1ael, (1aef), 1af, 1afy, 1agr, 1ag, 1ajx, (1al), 1alw, 1am, 1amf, 1aom, 1bck, 1bdx, (1bes), 1bkv, 1bnu, (1bv), 1bvb, 1cbr, 1cme, 1cmp, (1er), 1fd, 1ga, 1ii, 1nm, 1on, 1ow, 1ph, 1pl, 1qh, 1rw, 1sa, 1ts, (1uw), 1vf, 1xa, 1xq, (1xz), 1yb, 1yd, 1za, 1zn, 1zt, 2acn, 2ag, 2axf, 2azh, 2bg, 2bge, 2bgi, 2bir, 2bqb, 2br, 2bse, 2byk, 2byw, 2cfr, 2cgr, 2cjp, 2cvi, (2cvj), (2dn), 2ee, 2mc, 2fx, 2fj, 2ke, 2km, 2kw, 2le, 2mc, 2mk, 2mm, 2mu, 2nm, (2rk), 2xbf, 2xq, 2yi, 3aa, 3adq, 3aec, 3afs, 3alx, 3awa, 3az, 3baf, 3bb, 3bhv, 3bjp, 3bnn, 3bnu, 3bnw, 3bg, 3bsf, (3bta), 3caz, 3cgn, 3chc, 3chg, 3chl, 3fo, 3gk, 3gq, 3hh, 3kl, 3ll, 3lw, 3md, 3nf, 3nm, 3oe, (3ot), 3ox, 3sd, 3wb, 3xi, 4do, 4dq, 4eo, 4er, (4fw), (4gw), 4pd, (4pk), 4qf, 4sa, 4si, 4tg, 6ceu, 8ab, 8abs, 8acy, 8ada, 8agk, 8alb, 8aa, 8bau, 8bbf, 8bis, 8bk, (8bks), 8blk, 8bt, 8btw, (8buk), 8byn, 8bcq, 8cdt, (8ced), 8cej, 8che, 8cp, 8cpl, 8cta, 8cuk, 8cuy, 8cyi, 8dae, 8dah, 8dgp, 8dnb, 8dne, 8dnf, 8doo, (8dph), 8dsn, 8duo, 8fd, 8fm, 8fr, 8go, 8hp, 8jk, 8lr, 8pl, 8qp, 8rg, 8ry, 8uf, (8vq), 8wa, 8wo, 8xav, (9auw), (9azr), (9baq), (9cvb), (9cxs), (9chs), (9eas), (9eht), (9sr), (9zd), (nerk) at Lakehurst, N. J. NKF.

Canada: 1ei, 3nf, 5dq, (5go), 5ef.
 Mexico: bx, lb, lx, ??? QRA.
 British: 2od, 2oz, 2if, 2nm, 2ce, 2oz.
 New Zealand: 2ac, 2ag, 4aa.
 South America: cbs.
 French: 8ab.
 PCII, QRA?, JSW, QRA?

We hear about every station that is on the short waves and will gladly test with any dx station that desires. We work the east coast with ease and also send out a card for every one that comes in.

By 8CTQ, Walter C. Olson, 103 Sturgis St., Jamestown, N. Y.

5ae, 5ado, 5aeg, 5agv, 5ahd, 5ahw, 5ajn, 5ajt, 5akp, 5aky, 5amj, 5amk, 5amw, 5anl, 5apl, 5apq, 5apm, 5atg, 5aw, 5cc, 5es, 5gj, 5gq, 5hy, 5il, 5kr, 5qh, 5tw, 5vu, 5ws, 6aam, 6afh, 6ano, 6anx, 6awt, 6bas, 6bcu, 6bop, 6bjv, 6bku, 6blm, 6blu, 6bnh, 6bu, 6cae, 6cog, 6cgv, 6chx, 6cpc, 6cso, 6cul, 6kt, 6li, 6mf, 6pl, 6pz, 6ql, 6rv, 6uo, 7acr, 7aha, 7ahq, 7ald, 7ax, 7is, 7kl, 7kz, 7lh, 7ok, 7qu, 7sr, 9afp, 9amp, 9auv, 9ayd, 9beu, 9bjk, 9cfy, 9cid, 9evc, 9dkl, 9dtm, 9dwh, 9hg, nitz, nry.
 Canadian: 5ds.

By 6VF, 561 Brussels St., San Francisco, Calif.

1gv, 1kc, 1ow, 1pl, 1sf, (1xz), 1zt, 1abf, 1bsd, 1ckp, 1cmp, 2be, 2by, 2id, (2pd), 2rk, 2xi, 2xq, (2aqh), 2bum, 2cjj, 2cei, 2cqz, 2cvu, 3bh, 3hg, 3hj, (3qt), 3adq, 3auv, 3bva, 3cdg, 3chc, 3chg, (4bq), 4gw, (4io), 4jr, 4ku, (4my), 4oa, 4tj, (4xe), 5am, 5cn, 5ow, (5gf), 5li, 5lh, 5lu, 5qy, 5sd, 5se, 5uk, 5wa, (5za), (5acl), (5aex), 5ahd, (5aic), 5ajj, (5zav), 8cp, 8gz, 8yz, 8ze, 8aly, (8axn), (8bau), 8btf, 8bww, 6's, 7's and 9's too numerous. (NKF), WGH, QRA?
 Canadian: 5ak, 5ba, (5ef), 5hs, 4an, 4dq.
 Mexican: 1B, BX.
 New Zealand: 2AC, 4AA, (4AG).

By 6BBQ, F. F. Maciek, 194 South El Molino Ave., Pasadena, Calif.

1ci, 1qw, 1sf, 1amf, 1cio, (1cmp), 2kx, 2rk, (2bqu), 2cee, 2cei, 3hg, 3hh, (3qw), 3yo, 3bhv, (3bwt), 3cjin, 3cjp, 4bu, 4dq, 4eh, 4eq, 4fe, 4gw, (4ik), 4ku, (4who) QRA? 5ad, (5ak), 5an, 5bx, 5bz, 5ca, 5cn, 5ev, 5ek, 5ft, 5gj, 5gu, (5hi), 5kc, 5kr, (5lh), (5lm), 5ls, 5nj, 5ob, 5ou, 5qh, (5qi), (5qx), 5rj, 5se, 5uk, 5uo, (5uu), 5wi, 5aai, 5aaq, 5acf, 5adz, 5aex, 5agy, 5aic, 5ajg, (5ajt), 5akf, 5amw, 5anf, 5ank, 5apy, 5aqa, 5aqv, 5are, 5asd, (5ask), 5atf, 5xa, 5zai, 7bb, 7ca, 7cf, 7dd, 7df, 7dx, 7g, 7fm, 7gb, 7ge, (7gj), 7gm, 7gs, 7gu, (7gv), 7gz, 7hf, 7hw, 7ie, 7il, (7jh), (7kz), (7lh), 7lk, 7lw, 7mb, (7no), (7ob), 7oh, (7ok), 7ol, 7qc, 7qf, 7qy, 7rh, 7ry, 7sc, 7sl, 7sy, 7to, 7un, 7vn, 7vx, 7wp, 7abi, 7adf, (7ahi), 7aho, 7ahs, 7aif, 7ald, 7ali, 7alk, 7akk, (8gh), 8wa, 8xb, 8aig, 8avd, 8evx, 8axf, 8axn, 8baa, 8bqi, 8byn, 8bfz, (8bzt), 8cci, 8cjp, 8cko, 8cva, 8exi, 8dal, (8ded), 8dgt, 8dmg, (8zab), 8zah, 9bk, 9by, 9cm, 9dq, 9dr, 9mc, 9nl, 9ol, 9ql, (9wo), 9ws, 9zt, 9aaw, 9abb, (9ado), (9aefq), 9aeg, 9aex, 9ami, 9amx, 9and, 9aqs, 9atn, 9awm, 9avv, 9axx, 9ayl, 9azj, 9bdb, (9bdf), 9bdq, 9bdu, 9bdz, 9bej, 9beg, (9bio), 9biz, (9bji), 9bjk, 9bkj, (9bkk), 9bmk, 9bnf, 9bnk, 9bph, 9bqt, 9bre, 9buk, 9bvc, 9bvk, 9bvn, 9bvw, 9bxq, (9caa), 9cai, 9ces, (9cde), 9che, 9ci, 9cip, 9cjc, 9ckt, (9cni), 9cnt, 9cpq, 9csn, (9csy), (9cvi), 9cvo, 9cyi, 9dad, 9dac, 9dau, 9dbb, 9dbz, 9dfh, (9ded), 9dhl, 9dhw, 9djp, (9dno), 9doz, 9dpc, 9dqu, 9dsa, 9dun, (9dyi), (9eain), 9eak, 9ecl, 9efz, 9ejn, (9eky), 9xbn, Canadian: (5ba), (5cn), (5hc), (5ef), (4io).

Mexican: BX, 1B.
 New Zealand: 2AC, 4AG.
 British: 2OD.
 Continued on Page 90

For the Critical!

DAVEN RESISTANCE COUPLED AMPLIFIERS

Daven Amplifiers allow no distortion because all frequencies are amplified alike—they have convinced the most skeptical that Resistance Coupling is matchless. True amplification is therefore available to all who use our Super-Amplifier or build their own with our Knock-down Kits. Why not obtain from your set pleasure you have never before enjoyed? Obtain from your Dealer the "Resistor Manual," our complete handbook on Resistance Coupled Amplification, 25c. Post Paid, 35c.

Construct one yourself for either 3-stage or 4-stage or if you prefer a completely assembled 3-stage unit ask to see our Super-Amplifier.

SOLD EVERYWHERE

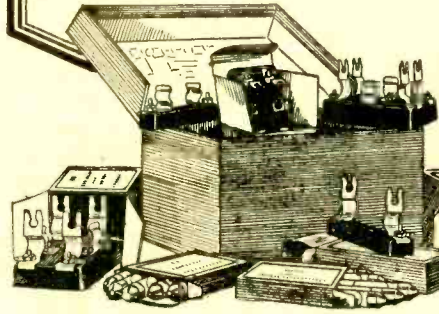

TRADE MARK
DAVEN RADIO CORPORATION
 "The Sine of Merit"
 Resistor Specialists

Newark, N. J.

Single hole mount

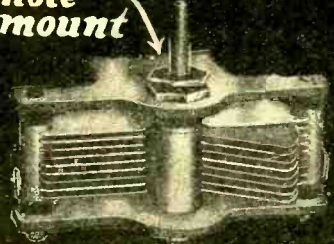

"NOL-LOS"
 Variable Condenser
 Capacity. 0.0005 M.F.
 \$4.00

The Grosser Condenser Adapted for Any Circuit

3 CAPACITIES	
.0005	\$4.00
.00035	\$3.75
.00025	\$3.50

Your Radio Hookup is not complete without a "Nol-Los" Condenser. The discriminating Fan demands it

- Because of its sharp tuning
- Because of distance and volume
- Because it has no body capacity
- Because losses are negligible.

Painstaking care has been given to the mechanical and resistive elements used in the construction of "Nol-Los" Condensers to the most minute detail. This Condenser has been subjected to the most severe tests in many of the most important Laboratories of the World and has proven expert in resistance to the Standard Condensers used in these Laboratories. When buying a Condenser insist upon "Nol-Los." If your dealer cannot supply you order direct.

B. Grosser Sons Co., Inc., Manufacturers

515 Sudbury Street

Dealers and Jobbers Write for Terms

Boston, Mass.

RADIO DEALERS WANTED
 BIG DISCOUNTS ON STANDARD PRODUCTS
W. C. BRAUN CO.
 32.40 S. Clinton St., Chicago
 ASK DEPT. 111 FOR DEALERS CATALOG



A COMBINATION 3 in 1 jack that can be used as single open, single closed, or double closed jack. Super-compact; solid bakelite; practically zero capacity. Distributed by F. L. TOMLINSON & CO. 443 S. San Pedro Street, Los Angeles, Calif.

Send for Trial Subscription
 \$1.00 for Six Months

Tell them that you saw it in RADIO

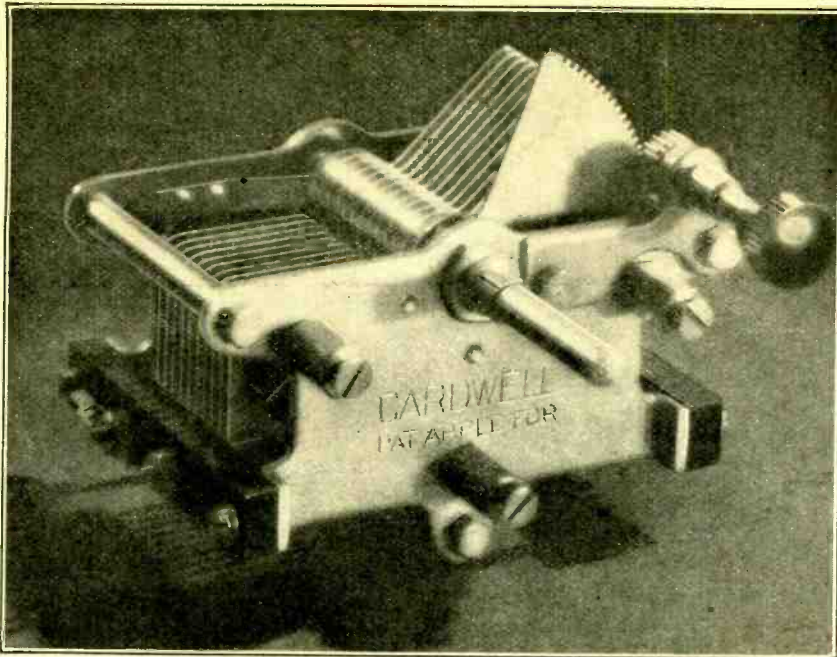

"No fancy gewgaws to attract the eye and cause trouble in the end"

SO writes Mr. Henry M. Neely, Editor of RADIO-IN-THE-HOME. Mr. Neely adds:

"The present-day low-loss condenser approaches more nearly to a perfect instrument, the more nearly it approaches the design and workmanship of the Cardwell."

Other points of merit have been praised by as many different experts. In fact, Cardwell condensers have received the universal approval of radio editors and engineers everywhere.

Simplicity is a distinctive characteristic of the Cardwell. There is no excessive bulk or weight — no intricate gears or complicated assembly.

Cardwell condensers are

rugged, free from play, noiseless and remarkably smooth in action. And there is nothing to work loose or get out of adjustment.

Cardwell invented the first "low-loss" condensers—a name originally applied only to Cardwells to distinguish them from ordinary varieties. Cardwell now makes seventy-six different types—a condenser for every requirement. Ask your dealer to show you his assortment.

A postcard brings you an education on condensers. Write today for the new Cardwell Condenser booklet.



The Allen D. Cardwell Manufacturing Corporation
81 Prospect Street, Brooklyn, N. Y.

CARDWELL UNITRADS

(RADIO UNITS OF MERIT)

CONDENSERS — INDUCTANCES — TRANSFORMERS

You Should Read It!

The Only Book of Its Kind

"The Radiobuster"
A remarkable book of 12 complete radio stories

Only \$1
Postpaid
Per copy

112 pages full of genuine radio humor. Many thrilling stories of radio life at sea.

Mail Your Order Today. The Supply Is Limited!

Pacific Radio Publishing Co., Inc.

Pacific Building
San Francisco

17 West 42nd St.
New York, N. Y.

157 E. Ontario St.
Chicago, Ill.

Continued From Page 89

By R. W. Mintrom, 62 Barton St., Woolston, Ch. Ch., New Zealand

1gv, 1yw, 1kc, 1ml, 1sf, 1ow, 1boa, 1cmp, 2xq, 2brb, 2bsc, 2cqq, 3bp, 3yo, 3amh, 3auv, 3bdo, 4io, 4kv, 4tj, 5cn, 5bz, 5ox, 5uk, 5ph, 5ow, 5mi, 5ajc, 5ail, 5aiu, 5ata, 5ajj, 5zai, 5zav, 5age, 6arb, 6agk, 6apw, 6aad, 6ase, 6aph, 6awt, 6afg, 6aan, 6adt, 6akw, 6ame, 6akz, 6aqd, 6ary, 6bqb, 6brf, 6bjj, 6bka, 6blw, 6bbv, 6buh, 6bcp, 6bur, 6cgo, 6cej, 6cmu, 6cto, 6chl, 6css, 6cmi, 6clp, 6cgk, 6cek, 6cnl, 6cfs, 6cae, 6czx, 6cet, 6cjj, 6ccy, 6xax, 6pl, 6lj, 6of, 6vo, 6eb, 6ne, 6fh, 6ao, 6gg, 6rn, 6zp, 6oi, 6gt, 7ij, 7fd, 7fr, 7lq, 7zm, 7om, 7dq, 7gb, 7abb, 7af, 7afn, 7sgz, 8vq, 8hn, 8cyi, 9bo, 9em, 9hk, 9xi, 9bm, 9zd, 9zt, 9hji, 9bhx, 9eky, 9egh, 9dqu, 9dqa, 9ely, 9eht, 9bec.

Canadian: 1ar, 1dd, 4cr, 5go.
Mexican: 1b, bx.
Chile: 9tc.
England: 2od.
Always glad to QSL on above reports if requested.

By 6CWI, Box 494, Blythe, Calif.

1aa, 1abf, 1acb, 1adg, 1agp, 1ajo, 1ajp, 1aku, 1amf, 1ary, 1atj, 1avg, 1axz, 1aza, 1ban, 1bdx, (1bgi), 1cab, 1cc, 1cp, 1ckp, 1pl, 1py, 1sf, 1uw, (1wl), 1xam, 1zo, 2aan, 2aay, 2aco, 2acx, 2afp, 2ag, 2ajt, 2axc, 2axf, 2azy, 2bgi, 2blp, 2bm, 2bmt, 2bqu, 2brb, 2by, 2cee, 2chg, 2cje, 2cix, (2cnk), 2cvf, 2cvj, 2cxw, 2dn, 2gk, 2kx, 2sz, (2wr), 2xaf, 2xi, 2xg, 3ach, 3adb, 3adq, 3aih, 3ajd, 3bhr, (3bjp), 3bmn, 3bng, 3bpm, 3bta, 3buy, 3cb, 3cdg, 3chg, 3cjn, 3hs, 3lg, (3sf), 3te, 3yo, (4do), 4eb, 4eg, 4gw, 4iz, 4kl, 4ku, 4pc, 4pd, 4pk, 4ff, 4xe, 5aai, (5aaq), 5ac, (5acf), 5acl, 5acm, 5adh, 5aec, 5aew, 5aex, 5afn, 5adm, (5agq), 5ahw, 5aiy, 5ajg, 5ajj, 5ajt, 5akn, 5akz, 5alj, 5alz, 5ame, 5amg, 5ap, 5apt, 5apy, 5aga, 5agy, 5arl, 5asb, 5asv, 5asz, 5aff, 5ca, 5hi, 5hy, 5in, 5ka, 5kc, 5mn, 5nw, 5nj, 5ot, 5ov, (5rm), 5rw, (5sd), 5se, 5uj, 5wa, 5wy, 5xau, 5zai, 7abb, 7acm, (7adm), (7afo), 7aha, 7ahi, 7aib, 7aig, (7aip), 7alk, (7av), 7cy, 7dc, 7di, 7g, 7gb, 7gj, (7gm), (7gr), (7gv), 7hw, 7ho, 7kr, 7lg, 7mp, 7mx, 7nx, (7qd), 7rh, 7rw, 7sp, 7sy, 7uj, 7un, 8acm, 8ah, 8alg, 8ame, 8awg, 8baj, 8bbi, 8bff, 8byf, 8cei, 8cp, 8cyp, 8cta, 8cuk, 8eva, 8dae, (8dfk), 8dnb, 8dpi, 8dta, 8eb, 8ig, 8lr, 8mt, 8pu, 8rg, 8ut, 8vg, 8ze, 8zk, 9aau, 9adf, 9adp, 9aey, 9agl, 9aki, 9akx, 9auw, 9axf, 9bal, 9bav, 9bcd, 9bdf, 9bdw, 9bje, 9bji, 9bmx, 9bnf, 9bpf, 9bwc, 9bxt, 9bzk, 9ccs, 9cfl, 9cip, 9cit, 9cis, 9ckl, 9cpo, 9eri, 9ero, 9ctg, 9cvl, (9cvo), 9cyk, 9czo, 9dad, 9daw, 9dbz, 9ddk, 9del, 9dgv, 9dit, 9dmj, 9dms, 9dmz, 9dng, 9doa, 9dpr, 9dpz, 9duo, 9dvr, (9eae), (9eam), 9efo, 9efz, 9egs, 9egu, 9eib, 9eij, 9eiy, 9es, 9fe, 9na, 9oa, 9ph, 9qw, 9xe, 9xi, 9zt.

Canadians—(3aa), 4bb, 4dq, 4fn, 4io, 5an, 5ct, 5ef, 5go, 5hp.
Australasian—z2ac, z4ak, a2yg, a3bd, a3bg.
Mexican—Bx, 1b, 9a.
NERKI, NKEP, NQG, q2mk, SU.

GLOBE LOW-LOSS TUNERS Loses Nothing
Tunes Every Radio
Impulse the Aerial
Receives

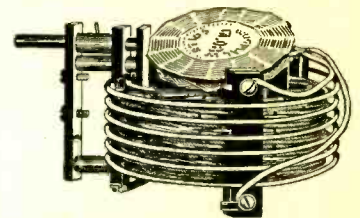

PATENTED DEC. 9, 1924

No Meta
No Eddy Current Losses
Large Wire
Self Supporting
Little Insulation
Low Distributed Capacity
Short Wave (35-135 Meters)
For Superdyne Circuit
R F Transformers
Anti-capacity Windings
Low R F Resistance
GET ORIGINAL GLOBE COILS
Standard Tuner (Broadcast Range) \$7.00
\$7.00
\$8.50
\$6.00
Circular on Request. Dealers and Jobbers Write.

SEND ORDERS DIRECT TO
Globe Radio Equipment Co.

217 West 125th St., N. Y. C.
Imitation is Deceit *Legal Action Pending

By 6BAV, 1362 Feger St., Fresno, Calif.
 1aak, (1aao), 1af, 1akz, 1all, 1atj, 1ban,
 1bbe, 1cab, 1cme, 1cmp, 1er, 1fb, 1gh, 1mc,
 1mm, 1oi, 1ta, 1zk, 1zt, 2aan, 2atq, 2bm,
 2br, 2cnx, 2cy, 2kf, 2kx, 2le, 2mu, 2nm, 2ra,
 2rk, 2su, 2wr, 3arz, 3bjq, 3bng, 3bq, 3bwu,
 3cb, 3cnu, 3jr, 3jw, 3lq, 4bq, 4db, 4ed, 4fm,
 4ht, 4gw, 4ku, 4pk, 4si, 4tw, (5aaq), 5adk,
 5aef, 5afu, 5ah, 5ahw, 5ain, 5ajh, 5ajt, 5akn,
 5alj, (5apt), 5asu, 5asz, 5bj, 5cn, 5ec, 5ew,
 5ka, 5kc, 5lh, 5nw, 5oq, 5ot, 5qw, 5sd,
 5se, 5tk, 5uk, 6's and 7's too numerous.
 Sada, 8bam, 8bau, 8bk, 8ced, 8cei, 8cni,
 8cra, 8cuk, 8dal, 8die, 8er, 8fm, 8lr, 8nb,
 8ze, 9adk, 9adz, 9ago, 9akk, 9aky, 9aod,
 9atj, 9axs, 9bal, 9dbf, 9dbu, 9blu, 9bmr,
 9bnk, 9bou, 9bvg, 9cak, 9cbz, 9cea, 9cgn,
 9cof, (9cpm), 9csg, 9cul, 9cum, 9cur, 9cvo,
 9cvr, 9dad, 9dlw, 9dm, 9dmj, (9dng), 9dwx,
 9eam, 9ego, 9ell, 9ct, (9mn), (9oa), (9vc),
 9zd.

Will QSL the above on request. QRK my 5 watter?

Continued on Page 95

**wonderful
startling!**



**The
NEW
UNCLE SAM
MASTER COIL**

THE COIL
WITHOUT LOSSES

- 1—Wound on moulded hard rubber.
- 2—Increases volume 50% to 250%. Also selectivity, over old type.
- 3—Eliminates all adhesives.
- 4—One hole mount and thin gold-plated compensating spring contacts.

FREE! Ask your dealer or send us four cents in stamps for wiring diagrams of circuits in which this remarkable coil can be used.

UNCLE SAM ELECTRIC CO.
213 E. Sixth St. Plainfield, N. J.

FREE!

**Everyone Interested
in RADIO
Should Write for
this FREE Radio Book**



The Greatest Bargain Catalogue published. Chuck full of thousands of Radio Bargains at the lowest prices to be found anywhere in the United States.

Parts, Supplies, Sets, Parts for Sets, Latest Circuits.

Send for this catalogue TODAY.

We have friends in every City, Town and Hamlet. Our reputation is our bond. No red tape. Honest merchandise, goods shipped on approval. No risk—satisfaction or money refunded, no arguments, no money in advance. Ask this magazine about us!

**Wholesale Radio Service
DEPT. Z
9 Church St., New York City**

It Has The Full Sweet Resonance of Our Upright Horn



The new cabinet model has a seasoned wood horn which is "full floating"—the outer end, or bell, does not touch the cabinet. This, together with a long expansion chamber, gives it that same freedom of vibration which goes to make the Bristol horn type Loud Speaker such a resonant, sweet-toned instrument. It also has the same high-grade electromagnetic sound mechanism. It is not only a handsome piece of furniture, but a speaker worthy of the best radio set that money can buy.

Cabinet Model, \$30.00

There are five Bristol Loud Speakers, priced from \$12.50 to \$30.00. If not at your dealer's, write for Bulletin No. 3020.

The Bristol Company, Waterbury, Conn.

BRISTOL AUDIOPHONE Loud Speaker

For 36 Years Makers of BRISTOL'S RECORDING INSTRUMENTS

Ask Any Technical Engineer

POATES NEW "1925" THREE COLOR RADIO MAP

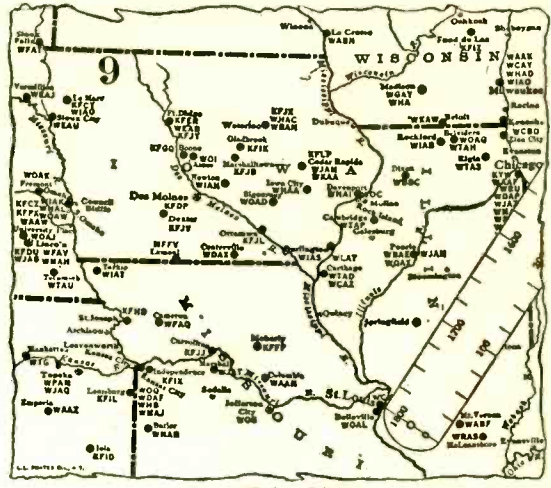

Size 28 by 34 in.

Shows: Broadcasting stations, wave lengths, frequency kilocycles, relay league divisions, standard time divisions and DISTANCE FINDER. If your dealer cannot supply you with POATES RADIO MAP, mail us 35c in stamps for copy, supplying dealer's name.

L. L. POATES PUBLISHING CO., Inc.
 Home Office:
 4 Washington Place, New York, N. Y.

Send for Trial Subscription—\$1.00 for Six Months

Best Super-Heterodyne Kit \$7.75

Complete With Drilled, Engraved and Polished Panel

Made up of the world's finest radio apparatus; 3 Remler No. 600 IFTrans, 1 Remler No. 610 IFTrans, 2 Federal No. 45 or Thordarson Audio Freq. Trans, 2 Federal 1422W Jacks, 1 Federal 1435W Jack, 1 Remler Coupler, 2 Federal Rheostats Nos. 18 and 23, 2 Remler Var. Condensers, 1 Chelton Midget Cond., 5 Remler Sockets No. 399, 2 Benjamin

Sockets, 1 Caldwell Low-loss 201-A Socket, 1 Weston jewelled voltmeter, 1 Carter Jack SW, 2 2-mid Fixed Condrs, Dubiliers .006, two .0025, .00025, .0005, Grid-leak, Amperite, 10 Eby Binding Posts, Eveready C-Batt, drilled and engraved panel, baseboard, shelf, bus wire, nicked screws, all bakelite needed. Complete \$7.75

(One-fourth cash required with order)

Radio Owners Service Co.

860 TWELFTH STREET OAKLAND, CALIFORNIA



It Does the Trick!

IT takes a MOUNTFORD Grid Leak to bring out the best qualities of any radio set—richness of tone—selectivity—volume—and distance.

MOUNTFORD Grid Leaks are guaranteed moisture-proof, noiseless and accurate!

Important! The MOUNTFORD process of securing terminals under pressure assures the perfect vacuum so essential to best results.

MOUNTFORD Grid Leaks are made in any resistance, and in two styles—the regular MOUNTFORD, standard for years, and the attractive MOUNTFORD DE LUXE.

Sold to Distributors and Manufacturers

Ask your dealer, or write direct—

C. E. MOUNTFORD

465-467 Greenwich Street New York

Manufacturer of Tested
GRID LEAKS



Over a Million in Use

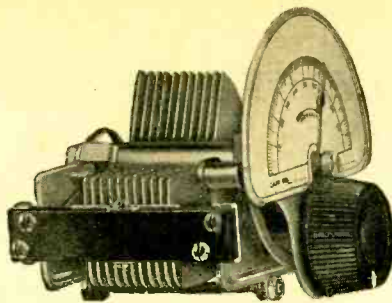

Here's A Condenser You Can Depend on

In offering the new Signal Vernier Variable Condenser no effort has been spared by our engineers to give the radio world the very finest low loss condenser we could build. And we build and sell condensers by the hundred thousand. Theory, laboratory tests and practical everyday experiments—all have entered into making it a condenser worthy of a place in the very highest grade receiving set.

Features of the Signal Condenser

put it in a class alone. Just check over these few: Brass plates and metal ends—soldered rotor and stator assemblies—clock-spring pigtail connection—unique logging dial and clock hand—cone bearings—grounded rotor—adjustable stator, etc. Now keep in mind that the whole is built and assembled with the precision of a fine watch and you can appreciate why we are proud of the Signal V. V. Condenser and why thousands are being bought every week.

The Price?

It's low for such a high quality instrument. 11 Plate—\$3.10; 17 Plate—\$3.20; 23 Plate—\$3.30; 43 Plate—\$3.50. Prices are slightly higher west of Denver and in Canada. Go to your local dealer. See, examine and buy a Signal. You will never own a more satisfactory radio unit. If your dealer does not yet stock the Signal V. V. Condenser write to us, sending his name and address and we will see that you are promptly supplied.

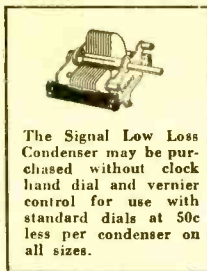

The Signal Low Loss Condenser may be purchased without clock hand dial and vernier control for use with standard dials at 50c less per condenser on all sizes.

SIGNAL ELECTRIC MFG. CO.
Menominee, Mich.

Branches In All Principal Cities

TUNE IN! Our Station KFLB, 248 Meters, Wednesday and Saturday, 8 P. M. to 10 P. M. Central Standard Time.

NEW WAVELENGTH ALLOCATIONS

Continued From Page 86

WPSC	Penn. State College, State College, Pa.	500 261	1150
WQAA	H. A. Beale, Jr., Parkersburg, Pa.	500 220	1360
*WQJ	Calumet, Rainbo, Chicago, Ill.	500 447.5	670
WRBC	Immanuel Lutheran Church, Valparaiso, Ind.	500 278	1080
*WRC	Radio Corporation of America, Washington, D. C.	500 468.5	640
*WREO	Reo Motor Car Co., Lansing, Mich.	500 285.5	1050
WRL	Union College, Schenectady, N. Y.	500 360	833
WRM	Univ. of Ill., Urbana, Ill.	500 273	1100
WRW	Radio Research Lab., Tarrytown, N. Y.	500 273	1100
*WSAC	Clemson College, So. Carolina	500 336.9	890
WSAG	Gospel Tabernacle, St. Petersburg, Fla.	500 266	1130
*WSAI	U. S. Playing Card Co., Cincinnati, O.	500 325.9	920
*WSB	Atlanta Journal, Atlanta, Ga.	750 428.3	700
*WSUI	State Univ. of Iowa, Iowa City, I.	500 483.6	620
WSY	Ala. Poly Inst., Auburn, Ala.	500 250	1200
*WTAM	Willard Stor. Bat. Co., Cleveland, Ohio.	1500 389.4	770
*WTAS	Chas. E. Erbstein, Elgin, Ill.	1000 302.8	990
WTAY	Oak Leaves Broadcast Sta., Oak Park, Ill.	500 250	1200
*WTIC	Travelers Insurance Co., Hartford, Conn.	500 348.6	860
WWAE	L. J. Crowley, Joliet, Ill.	500 242	1240
*WWJ	Detroit News, Detroit, Mich.	500 352.7	850

* Class B Station.

The Andrews Paddlewheel Coil

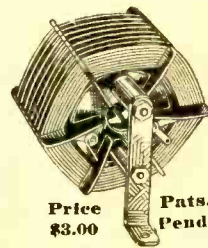

Price \$3.00 Pats. Pend.

A new low-loss coil of ideal characteristics for use with many different types of circuits. No dope used on windings. Moisture proof and unaffected by climatic changes. Has exceptionally high ratio of inductance to resistance. Your results will be greatly improved by using this superior coil. Its exclusive construction assures maximum amplification, minimum distortion and much greater selectivity.

This coil, which is the type employed in the ANDREWS DERESNADYNE RECEIVER, is manufactured under license from the Andrews Radio Company.

Write for full information regarding this wonderful new coil, its characteristics and its uses.

DUO-SPIRAL FOLDING LOOP

A special model for every circuit. Easily portable. Rotates on base which has silvered dial graduated for calibration. Handle permits adjustment without body capacity effect. Handsomely finished in silver and mahogany.

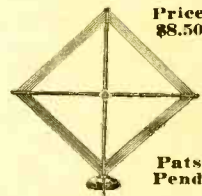

Price \$8.50 Pats. Pend.

Write direct, if your dealer cannot supply you.

Radio Units Inc.

1303 First Ave. Maywood, Ill
Perkins Electric, Ltd., Montreal

14-inch Bell Polished Pyralin



Aluminum Sound Column

Burns A Speaker of Distinctive Lines

Full volume without sacrifice of clearness or naturalness. Reproduces true tones of voice or music. Equal to hearing the original.

No. 100 Speaker Unit supplied for phonograph use—fits any make.

No. 205B—Polished black flare.....\$22.50

No. 205D—Shell pyralin flare..... 25.00

No. 100 —For phonograph use..... 10.00

Manufactured by

American Electric Company
State and 64th Streets, Chicago

RADIOCAST WEEKLY

48 Pages of
Programs, Photos, Humor,
Musical Reviews, Schedules,
Tables, Editorials, Etc.

5c Per Copy Radiocast Weekly
433 Pacific Bldg.,

SAN FRANCISCO



New "Bruno" 77

Low Loss Tuning Coil

for Regenerative-Reflex-Superdyne-Superheterodyne Circuits.
The only coil wound on "Quartzite" Rods, quartz being by far the best insulator known. Another original feature is its distinctive form of tickler which permits the coil to go into oscillation gradually. Genuine Litz wire is used instead of the ordinary stranded wire. Also, the wires will not become loose as is often the case with coils wound on hard rubber. Avoid the whistles and squeals of ordinary regenerative Tuners by insisting on the NEW "BRUNO" LOW-LOSS COIL.

Price, \$7.00

If your dealer can't supply you, send money order and his name to

BRUNO RADIO CORP.
300 Water St. New York City

Pacific Coast Representative:
A. S. LINDSTROM
274 Brannan St. San Francisco

A DOZEN THRILLING YARNS

Read the Story of the Life of a Sea-going Radio Operator—
"THE RADIOBUSTER"
Sent Postpaid Anywhere

PACIFIC RADIO PUB. CO.
Pacific Bldg., San Francisco, Cal.

\$1 Per Copy **\$1**

EVERY B-T USER IS A B-T BOOSTER

Read What They Say!

R. A. Bradley, Technical Editor of "Wireless Age" says "the results obtained with your tuner have never been equaled by myself nor any of my associates. Its selectivity was greater than any receiver that I ever operated. The adjustable coupler is one of the most valuable things that has ever been added to the regenerative type tuner." (See December Wireless Age for Hook-up.)

Arthur G. Wester, (Radio 2WR) Asst. Div. Mgr. American Radio Relay League received the following with our Short Wave Tuner. "New Zealand 4AA on 80 meters. Estimated distance 9600 miles. Mexican BX and numerous stations all over the U. S."

See these B-T parts at your dealers! Our 40-page book, Better Tuning, containing complete details, hookups, tuning, construction and general information, postpaid for 10c.

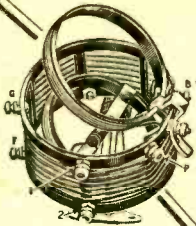

B-T LOW LOSS TUNER
Made for Broadcast or Shortwave Work. Ranges covered with B-T L-11 Lifetime condenser.
Type B 200 to 565 \$5.00
Type SW 50 to 150 5.00

B-T Type	Lifetime Condenser M.M.F.	Price
L-7	125	\$4.25
L-11	250	4.50
L-25	500	5.00
L-35	750	6.50

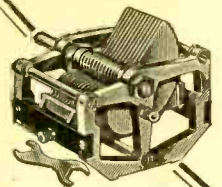

BREMER-TULLY MFG. CO.

532 S. CANAL ST., CHICAGO, ILLINOIS

EBY BINDING POSTS



A mounted strip for \$1.25

Seven nationally advertised EBY posts engraved in popular markings, equipped with tin soldering lugs and mounted on a polished hard rubber strip!

Each strip, including nickel-plated brass brackets and nickel-plated wood screws, packed in individual carton.

Special strips at special prices to manufacturers.

If your dealer doesn't stock them—write us!

H. H. EBY MFG. CO.
PHILADELPHIA, PA.

SUPER-HETERODYNE

25^c

Reprints from "RADIO" by
G. M. BEST. Sent to any
address for 25 cents
PACIFIC RADIO PUB. CO.
Pacific Building—S. F., Cal.

Only a Few Left

They say—

(Continued from last month)

- 9** "A Royal will reproduce the tones perfectly . . . without discordant noises. Compare it . . . in quality of tone reproduction."
Royal amplifies with Thordarsons!
- 10** "If it's in the air, Thermiodyne will get it regardless of distance. No distortion, no howling."
Thermiodyne amplifies with Thordarsons!
- 11** "Pure tone—remarkably clear and sweet reproduction."
Pathe amplifies with Thordarsons!
- 12** "Gives any degree of volume desired—without distortion. Exceptionally mellow tone quality—a tone charm that eliminates harsh or mechanical notes."
Michigan amplifies with Thordarsons!

SUPER HET BUILDERS!
For the "Best" 45,000 Cycle Super-Heterodyne, "RADIO" and other leading publications recommend in highest terms the Thordarson 2:1 ratio transformers. Take no others!

Follow the Lead of the Leaders! Build or replace with Thordarsons

ZENITH
KENNEDY
Radiodyne
THERMIODYNE
ULTRADYNE
MURDOCK
QZARKA
Pfanstiehl
MICHIGAN
Deresnadyne
MALONE LEMON
MASTER RADIO
ROYAL
Howard
Pathe
HARMONY
AUDIOLA
GLOBE
EAGLE AND
MANY OTHERS
USE THORDARSONS

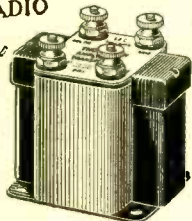

THORDARSON ELECTRIC MANUFACTURING CO.
Transformer specialists since 1895
WORLD'S OLDEST AND LARGEST EXCLUSIVE TRANSFORMER MAKERS
Chicago, U.S.A.

Unconditionally Guaranteed
THORDARSON
Super
AMPLIFYING TRANSFORMERS
Standard on the majority of quality sets

TYPES AND PRICES: Thordarson "Super" Audio Frequency Transformers are now to be had in three ratios: 2-1, \$5; 3½-1, \$4; 6-1, \$4.50. Thordarson Power Amplifying Transformers are \$13 the pair. Thordarson Interstage Power Amplifying Transformer, \$8. Write for latest hook-up bulletins—free!

Get One of These Books!

FREE

For a limited time only. Order Now!

"Elements of Radio Communication," "The Radio Buster" (by V. G. Mathison), "A-B-C of Radio," a non-technical book. One of these books given FREE with only one subscription to "RADIO" for 1 year. Simply send \$2.50 and the book is yours.

"RADIO" - - - - - Pacific Building, San Francisco

BLUEBIRD

Radio Tubes

Distinctly New



AND EFFICIENT, satisfying every radio fan's wish in perfect performance and price. Our direct sales plan enables us to sell at this low figure. "Bluebird" assures increased range and undistorted volume.

- Type 400—5 Volts, 1 Ampere Detector Tube
- Type 401A—5 Volts, .25 Ampere Amplifier and Detector
- Type 499—3-4 Volts, .06 Ampere Amplifier and Detector
- Type 499A—3-4 Volts, .06 Ampere with Standard Base Amplifier and Detector
- Type 412—1½ Volts, .25 Ampere Platinum Filament Amplifier and detector

All Standard Types . . . \$2.00

TYPE 402 5 WATT TRANSMITTER . . . \$3.00

EVERY TUBE GUARANTEED

to work in Radio Frequency. Especially adapted for Neutrodyne, Reflex and Super-Heterodyne Sets.

READ WHAT CUSTOMERS SAY:

Russellville, Mo.

Please find enclosed check for \$5.00 for which send me two Type 401A tubes. Your tubes are the best I ever tried.
ERNEST LESLIE.

Shipped Parcel Post C. O. D.
When Ordering Mention Type

BLUEBIRD TUBE CO.

Dept. R, 200 Broadway NEW YORK CITY

Send for FREE Bulletin 94

Whether you plan to build or to buy a receiving set, it will pay you to know something about the "insides" of radio. This booklet gives you the "inside dope" on some of the recent inventions embodying the latest ideas of radio engineers. In this bulletin is full information about the

Premier "HEGEHOG" Audio Transformer

Ratios 1 to 3, 1 to 4, and 1 to 5, \$3.50

Ratio 1 to 10 \$4.50



This light weight audio transformer has earned a place in the very front rank for its remarkable volume and pure, natural tone. It is 100% self-shielded against foreign noises.

Its small size is a surprise to everyone. It cuts the space requirements for audio transformers in two. This is a big advantage in portables and makes it ideal for neat and compact wiring.

FREE HOOKUP DIAGRAMS also sent on request. All popular types. Address

PREMIER ELECTRIC COMPANY
3813 Ravenswood Avenue Chicago

PREMIER

Quality Radio Parts

CALLS HEARD

Continued from Page 96

At 1PY, Longmeadow, Mass.

4bx, 4eq, 4er, (4fm), (4fq), 4ft, 4je, (4jr), 4kl, 4mi, 4oa, 4pk, 4rr, 4ua, 4afu, 4aic, (4ajt), (4alj), 4aqw, 4hi, 4in, 4ka, 4od, 4sd, 4uk, 4vv, 4wo, 4aao, (4ab), 4ac, (4agk), (4ahp), 4aji, (4alw), 4amo, 4apw, 4arb, 4awt, 4bav, (4bel), (4bdt), 4bfp, 4bgc, 4bhv, 4br, (4bjj), 4bka, 4blw, 4bmw, 4bqr, 4bur, 4cct, 4cggw, 4cdn, 4chl, 4cks, (4cmg), (4cmu), 4cni, 4crx, (4cso), 4css, 4csw, 4cto, 4cwi, 4czx, (4fy), 4ji, 4lh, 4pl, (4ts), 4xl, (4zh), 7aif, 7aig, 7ajv, (7ajy), 7bk, 7dj, 7fq, (7gb), 7gj, 7gm, (7ku), 7pz, (7rw), 7uj, (9aad), (9acq), 9adp, (9ahq), 9aky, (9bn), (9bjl), (9bht), (9bva), (9cir), (9cpm), (9cwf), (9dng), (9ear), (9eht), (9efz), 9qw, (9ui), (9vc).
 British: 2by, 2jf, 2kf, (2kw), (2nb), (2nm), 2od, (2sz), (5ma), 5nn, 5rz, 6nf, 6ry, (6vp).
 Canadian: (1ei), (2au), 2bv, 3tf, 3xi, (5ba), 9al.
 French: 8ab, 8bo, (8ct), 8go, 8gp, 8eu, 8sm, 8ssc.
 Dutch: pcl (Oba), Oll.
 Belgian: p2.
 Australian: (2yi),
 Army: (wvq).
 Navy: nkf, nfv.
 Mexican: 1k. SJ QRA? 1x QRA?

By SZE-SGX, Oberlin College, E. W. Thatcher, Oberlin, Ohio

6aao, 6ac, 6acl, 6adt, (6afg), (6agk), 6aha, (6ahp), 6akz, (6aiq), (6alv), (6aji), 6akw, 6alk, (6ame), 6amo, 6apw, (6aqd), 6arb, (6arx), (6ase), 6ats, (6awt), 6bau, 6bb, (6bdt), (6bge), (6bhz), (6bjj), 6bjx, (6blw), 6bnu, 6bny, (6bqr), 6bqu, 6caj, 6can, 6cg, (6cgo), 6cggw, 6cek, 6chl, (6cix), 6civ, 6cla, (6cmi), (6cni), 6crx, (6css), 6cqe, 6ess, 6csw, (6cto), 6cvu, 6cvx, 6czx, 6ea, (6eb), 6gc, (6gt), 6lj, 6ne, (6of), (6oi), 6ol, 6pl, (6rm), (6ts), 6vc, 6vo, 6ui, 6ut, 6xl, (6zp), 7abb, (7afn), 7afo, 7agl, 7ahi, 7aib, (7bj), 7dj, 7fh, (7fg), (7gb), 7gr, 7ij, 7ix, 7iy, (7ku), 7lq, 7ls, 7mf, 7mp, (7nx), 7ot, 7qd, 7sf, (7sp), 7ry, 7th, 7zm.
 Dalite, (6ase), (6oi), 7qd, 7abb.
 Glad to QSL to any station desiring report. Drop us a card OM. Especially want reports from Nevada, Idaho, and New Mexico. Tnx-"GX".

By 6CUWD Cason Mast, Bisbee, Arizona

2wz, 3na, 3pp, 3qw, 4ll, 5ak, 5co, 5ed, 5ei, 5er, 5ez, 5kc, 5kk, 5ms, 5qk, 5qh, 5qx, 5vu, 5zf, (5adv), (5adz), 5aek, (5amb), (5amk), 5anu, 5apq, 5ath, 5ato, 5att, 5gu, (5gv), 6iu, (6li), (6pz), 6rq, 6uo, 6vs, 6ws, (6aam), (6acn), (6afh), (6ahq), 6ava, 6ajh, 6ake, 6ala, 6amm, (6ano), 6aog, 6arx, 6asv, 6avj, 6awe, 6awx, (6bku), (6bkw), 6bmo, 6bsh, (6bvm), (6cah), (6cie), (6cje), 6clv, (6cou), (6cge), 6cz, (6cso), 6cta, 6ctl, 6cum, 6evj, (6cjd), 6eo, (6rs), (6mp), 7ahs, 7ajt, 7ald, 7lh, 7ok, 7oq, 7st, 7un, 7us, 8bn, 8ki, 8adb, 8afq, 8apn, 8azw, 8bjt, 8bnc, 8dgl, 8dpo, 8ccl, 8fl, 8gc, 8ry, 8su, 8afp, 9akk, 9anz, (9aon), 9avv, 9bay, 9bfp, 9bhz, 9bjp, 9bpm, (9caa), 9cid, 9col, 9cvm, (9cxg), 9dac, 9dan, (9dhw), (9dki), 9dpc, 9dwr, (9eam), 9eao, 9ebj, 9efe, 9ejy. WL appreciate RPTS on MI SIGS GLD to QSL to ANIONE.

At 1HX 24 Converse St., Longmeadow, Mass.

(4it), 4iz, (4jr), (4js), 4kl, 4ku, (4my), 4rm, 4si, (4sx), 5acm, 5ail, 5apt, 5aqp, 5hl, 5hy, 5lh, 5lu, 5ly, 5qo, 5se, 5uc, (5uk), 5wo, 5agk, 6alw, 6apt, 6ase, 6bhv, 6bru, 6cgv, 6c to, 6pl, 7af, 7ku, 9ady, 9axs, 9blb, 9bnk, (9bmx), (9cvf), (9ddv), 9duj, 9na, 9mv, (9pb).

British: (2kw), 2jf, 2kl, 2kz, 2od, 2wj, 2nm, 5mo, 6nf. French: 8ab, 8cz, 8arc, 8hsg? Australian: 3BQ, QRRK mi 5 watter? Pse QSL all crds ansd.

By 8BLP, J. J. Healy, 125 Spruce Ave., Rochester, N. Y.

C. W.: (1aid), (2ku), (3bjp), (4dx), (4dv), (4mi), (4pd), (5aek), (5acl), (5agl), (5afq), (5ash), (5ek), (5vi), (5uj), 6ao, 6aao, 6aad, 6aay, 6abk, 6acm, 6adt, 6afa, 6arf, 6age, (6agk), 6ahc, (6ahp), 6ahu, 6ajf, 6ajh, 6ak, 6akz, 6alo, 6ame, 6amw, 6aoi, 6aou, 6arb, 6aso, 6aau, 6awt, 6bbc, 6bel, 6bep, 6bes, 6bdi, 6beo, 6bjy, 6bkl, 6blw, 6bmw, 6bnt, 6bnu, (6bpb), 6bql, 6brf, 6bui, 6bum, 6bva, 6cgv, 6cic, 6ckp, 6ckw, 6cmr, 6cng, 6cni, 6cte, 6ea, 6eb, 6en, 6gr, 6js, 6lu, 6nb, 6nx, 6pl, 6rm, 6rv, 6tc, 6wt, 6xh, 6xi, 7abb, 7adr, 7aea, 7arn, 7ahv, 7aif, 7ald, 7alk, 7bj, 7co, 7du, 7gq, 7ks, (7lr), 7lu, 7ly, 7sc, 7sf, 7wm, 7zd, (8bwb), (9bhl).

Can.: 1AR, (2AX), (3NF), 5GO.
 British: 2NM, 2KF.
 French: 8AB.
 All cards answered. All heard during January.

RADIOADS

A Classified Advertising Section Read by Better Buyers

The rate per word is eight cents net. Remittance must accompany all advertisements. Include name and address when counting words.

ADS FOR THE APRIL ISSUE MUST REACH US BY MARCH FIRST

ARC & SPARK SYSTEMS
 Send for Descriptive Circular QRD.
 Interesting and Instructive
 Pacific Radio School 433 Call Bldg., San Francisco

VACUUM TUBE HOSPITAL
 We repair and guarantee them.
 Agents, Dealers, and Customers Wanted.
 Radiotube Co., 903 Broad St., Newark, N. J. tc

BIG MONEY AND FAST SALES—every owner buys gold initials for his auto. You charge \$1.50, make, \$1.44. 10 orders daily easy. Sample and information free. World Monogram Co., Dept. 68, Newark, N. J. (SAS)

RADIO GENERATORS—500V 100 watt \$28.50 Battery Charging Generator \$8.50. High Speed Motors. Motor Generator Sets, all sizes. MOTOR SPECIALTIES CO., Crafton, Penna. (tc)

AGENTS WANTED TO ADVERTISE OUR GOODS and distribute free samples to consumers; 90c an hour; write for full particulars. American Products Co., 2132 American Bldg., Cincinnati, O.

STORAGE "B" BATTERIES are easily made in one evening. Use my genuine Edison elements. A. J. Hanks, 107 Highland Ave., Jersey City, N. J. (3T)

15 to 25 per cent discount on nationally advertised sets and parts. Every item guaranteed. Tell us your needs. IMPERIAL RADIO COMPANY, Delaware, Ohio.

FINE KENNEDY SET—200-3200 meters—Detector and Amplifier. Detector has flush voltmeter installed, set complete with tubes and Radiola 12-1320 Horn, less batteries \$115.00. Reception from Missouri, California on the West and Massachusetts on the East. M. R. Martin, Oregon, Mo. (2T)

AGENTS—WORLD RADIO AND SPORTING MANUAL. Quick Cleanup. Sample 10c. Realtime Co. L 60, W. Washington, Chicago. (6T Exp July)

FOR SALE—Why bother with dry cell? Build an everlasting "HAWLEY" storage "B" battery of the nickeliron type. No frying or hissing, clearer reception, and greater volume. Put up in both knock-down units and assembled types. Requires no soldering or former experience to put together. Knock-down units contain all the parts to build the following sizes: 90 volt \$8.95; 100 volts \$9.95; 120 volts \$11.60; 135 volts \$12.75; 150 volts \$13.90; 200 volts \$17.50. Sold on a 2 year guarantee with 30 day trial offer with return of your money without any ifs nor ands. Sample cell 35c prepaid. 8 page illustrated folder of instructions containing simple means of putting together, making charger, and charging. Complete manufactured charger \$2.75. Order direct or write for my literature, guarantee and testimonials. Same day shipments. Address B. E. Smith, 31 Washington Ave., Danbury, Conn. (TC)

2650 MILES DISTANCE with one tube. Any novice understands our Simplified Instructions including Panel Layout, picture diagrams, etc. Write for BIG FREE BOOKLET. VESCO RADIO CO., BOX 117-RC, OAKLAND, CAL. (TC)

The way to get away and stay away from that terrible interference; \$1.00 brings detailed tested hookup for any wavelength. Radio Electric Service, 578 So. Holyoke, Wichita, Kansas.

KENNEDY UNIVERSAL, 175-26,000 meter receiver. Perfect condition, \$50. R. C. A. M-1008 Oscillation Transformer \$5.00. Lawrence Mobley, San Luis Obispo, California.

BURN-OUT RADIO TUBES REFILLED, \$1.75. Models UV-199, UV-201-A, UV-200, C-299, C-301-A, C-300. First class work and immediate service. We guarantee every tube we repair to be absolutely as good as new when it leaves our hands. Each \$1.75. S. P. HANKINS & CO., 660 Twelfth St.,

WANTED—A position as Manager or building, repairing, testing receivers any make. Four years experience. Know radio well. Further information write National Radio Institute, Washington, D. C., of which I am a graduate. Emmett Welch, Radio Engineer.

FOR SALE CHEAP—Used parts for a 10-watt self-rectifying transmitter using A. C. I need the money. Write for particulars. Oscar Denner, Gridley, Calif.

SUPER FORD 55 M. P. H.—No vibration at any speed. No change in rear axle. Smooth as Big 6. Full instructions and photographs of each operation required for you to alter your motor. Best, and most inexpensive way. The book mailed on receipt of \$1.00. The Mechanical Engineer & Designer, Box 55, Los Angeles County, Huntington Park, Cal. (2T).

EXTRA SPECIAL BARGAINS. Thermo-couple Antenna Ammeters, 0-2.5 amps. \$7.00, 0-5 amps. \$5.25. D. C. Voltmeters, 0-1500 volts, \$15.00. D. C. Williams—All these meters are manufactured by the General Electric Co. Other bargains, Roller-Smith Co. Hot Wire Ammeters, 0-2.5 amps. \$3.25. Bakelite Sheets, 30x38", 1/4" thick, regular price \$29.50, our price \$12.50. All merchandise is brand new and guaranteed. References, American Radio Relay League, American Sales Agency, 38 Park Row, N. Y.

Low loss coils of any description can be wound on Trirad metal forms easily and quickly. Will pay for itself in a short time. A great time and labor saver. Price \$3.00 per set. Write for circular. J. Zied, 540 Callowhill St., Philadelphia, Penna.

Why buy dry B batteries when an Edison element storage B battery will last you a lifetime. A 100 volt unit assembled and wired with pure nickel wire for \$12.00 is a real buy. 50 volt unit \$6.50. First grade, type A elements, 5c per pair. Heavy 3/4"x6" flat bottom containers 3c. No. 20 pure nickel wire, 1c per lb. Perforated hard rubber separators, 1/2c each. 100 volt drilled rack, \$1.95. Prices F.O.B. Phila. J. Zied, 530 Callowhill St., Phila., Pa.

Send us your burnt out tubes and get a genuine refill for only \$1.75. Ask us to quote you our wholesale price on any standard part. Radio Specialty Sales Co., Box 404, Berkeley, Calif.

MAKE YOUR NEUT REACH OUT—Same panel, same layout, fewer parts. Our \$5.00 kit includes the one different part, 22 feet real gold sheathed wire, lithographed print of Kladag Coast to Coast Circuit, and complete simple instructions. Nothing else to buy. Gives selectivity with deep, resonant volume. Not obtainable elsewhere. We originated this and can name scores of buyers it has delighted. Satisfaction guaranteed. Details 10c. Kit prepaid anywhere, \$5.00. New 48 page catalog, thousands of items, many exclusive—for stamp. We accept postage stamps same as cash. Kladag Radio Laboratories, Kent, Ohio.

For the rechargeable "B" battery; large size, clean, Edison elements, wired with pure nickel wire, ELECTRICALLY WELDED CONNECTIONS .07 1/2 per pair postpaid. "Dope" sheet and sample .10 cents. Perforated hard-rubber separators, 1/2 cent each; No. 20 nickel wire .01 1/2 per foot; Willard Chemical Charger \$2.00; 6 1/2 volt, 225 ampere hour Edison battery \$35.00. Arthur Chapelle, 7NX Woodburn, Oregon.

AGENTS—Signs for stores and offices. Entirely new. \$50 week easily made. World signs, 116 W. Washington, Chicago. (TC).

Write us for wholesale prices on any radio parts you need. Radio Specialty Sales Co., Box 404, Berkeley, Calif.

FOR SALE—D. C. C. W. het. including a 550 volt Westinghouse M. G. Acme grid coil and inductance, milliammeter, filament meter, radiation meter, filament transformer, four 1 inf. condensers with Acme double choke and grid leak and condenser, 2 sockets and one 5 watt tube. DX 9000 miles. 6KJ.

2,650 Miles distance with one tube. Any novice understands our simplified instructions, including panel layout and photo. 25c. Vesco Radio Co., Box R-117, Oakland, Calif.

Get a real guaranteed storage B battery 90 volts \$14.25. 45 volts \$7.75 with charger and filler. Ruf Radio Lab., Santa Clara, Cal.

MEN, WOMEN! Does 160% profit interest you. Spectacles, Eyeglasses, Goggles will not become misty, steamy, blurred. Sheds rain on windshields. Write Fulgentine Co., 801 So. Farragut St., Bay City, Mich.

Use Any Tube

UV-200 or C-300



Volts—5
Amps.—1
Grid Leak
0.5—2
Megohms
Condenser
.00025
.0005 M-f.

UV-201A or C-301A



Volts—5
Amps.—.25
Grid Leak
2—9
Megohms
Condenser
.00025 M-f.

WD-12 or C-12



Volts—1.1
Amps.—.25
Grid Leak
2—3
Megohms
Condenser
.00025 M-f.

WD-11 or C-11

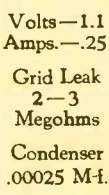

Volts—1.1
Amps.—.25
Grid Leak
2—3
Megohms
Condenser
.00025 M-f.

UV-199 or C-299



Volts—3
Amps.—.06
Grid Leak
2—9
Megohms
Condenser
.00025 M-f.

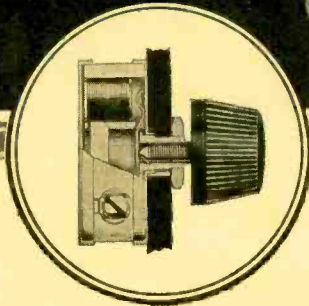

Bradleystat
PERFECT FILAMENT CONTROL

Bradleyleak
THE PERFECT GRID LEAK

Do You Know—

*that any tube can be used in your set?
without changing rheostats or grid leaks?*

IT SOUNDS unbelievable, but it's true. The perplexing problem of selecting the correct rheostat or grid leak is solved by using the Bradleystat and the Bradleyleak. They offer the most marvelous range without steps or noise, and such smooth precision of control that no other rheostat or grid leak can approach them in performance.

The Bradleystat has a resistance range from approximately $\frac{1}{4}$ to 100 ohms, by merely turning the adjusting knob that varies the pressure on the graphite discs. It will handle *all tubes* without change of connections, and provide ample control in every case.

The Bradleyleak, with a range from $\frac{1}{4}$ to 10 megohms, can be adjusted instantly for any tube, indicated in the adjoining table of tube ratings, by turning the adjusting knob.

Be ready to use any tube in your radio set. Install Allen-Bradley Radio Devices, throughout.

Allen-Bradley Co.

ELECTRIC CONTROLLING APPARATUS

Sales Offices:
Baltimore Chicago
Birmingham Cincinnati
Boston Cleveland
Buffalo Denver
Detroit



Sales Offices:
Knoxville Pittsburgh
Los Angeles Saint Louis
New York Saint Paul
Philadelphia San Francisco
Seattle

General Offices and Factory: 288 Greenfield Ave. Milwaukee, Wis.

Manufacturers of Graphite Disc Rheostats for Over Twenty Years

Have you
used the
Bradleyswitch?
It saves
batteries and
tubes.

GENERAL RADIO Condensers

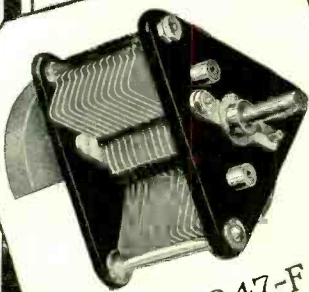

Type 247-F

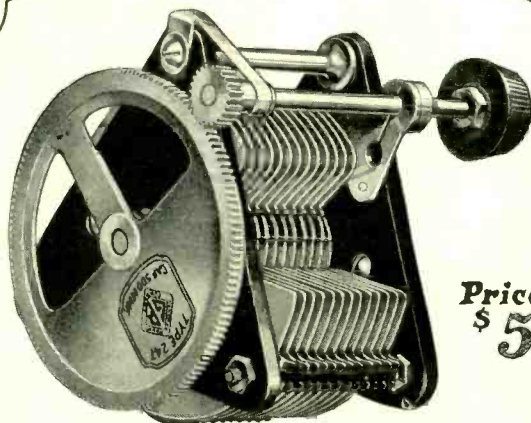

Type 247-H

Price
\$5

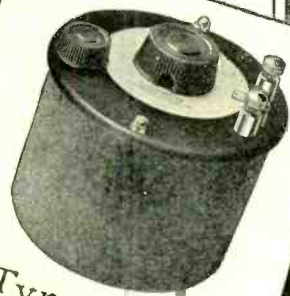

Type 247-G

The Standards of Excellence Since 1915

THE original low loss condenser was introduced in 1915 by the General Radio Company.

This instrument heralded an era of rapid advancement in the science of radio.

Today the design and performance of the General Radio Type 247 Condensers merit their distinction as the standards of excellence:

Eight different models are now available for various radio requirements. All of these models incorporate the following features, which contribute to lower losses and greater efficiency:

Low resistance losses, because of soldered plates.

Straight line plates, which give a uniform wave-length variation.

Plates always in perfect alignment, being individually straightened before assembly in a jig, and firmly soldered while in position.

Rotor plates counterbalanced to permit greater precision of adjustment.

Mechanically rugged design, which insures faithful performance over long periods of use.

Tight and smooth running spring bearings, adjusted to compensate for wear.

Popular prices, made possible by large-scale production and efficient methods.

Ask your dealer or write for instructive folder "Quality Condensers," containing complete information on all 8 models of General Radio Condensers.

The red cartons with the General Radio label are your unfailing assurance of satisfaction.

GENERAL RADIO Co
Cambridge, Mass.



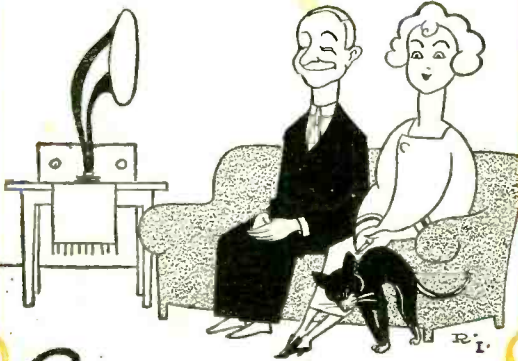
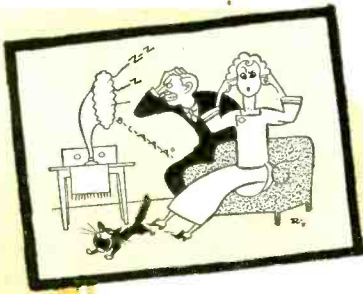

No set is better than —it's Loudspeaker

The one big thing in radio is *tone*. If you are listening to music, you want the tone so exact that it carries over the very personality of the artist. If you are listening to speech, you want the human voice—not a “radio voice.” If you haven't heard a Radiola Loudspeaker, you may not know how clear it *can* be.

Try a Radiola Loudspeaker on your set and you will get the finest tone the set can produce—as clear as on a fine pair of headphones, but thrown out into the room in full volume for the whole family to enjoy.

Radiola

REG. U. S. PAT. OFF.

LOUDSPEAKER



This symbol
of quality is
your protec-
tion.



RADIO CORPORATION
OF AMERICA

Sales Offices:

233 Broadway, New York
10 So. La Salle St., Chicago, Ill.
28 Geary St., San Francisco, Cal.